

**LA6**

\* There is no Silver (U) body color selection for the LJ type.  
 \* 100V - 240V AC type is only available for LA6-5AWJWB-RYGBC.

**LA6-5DLJWB-RYGBC**

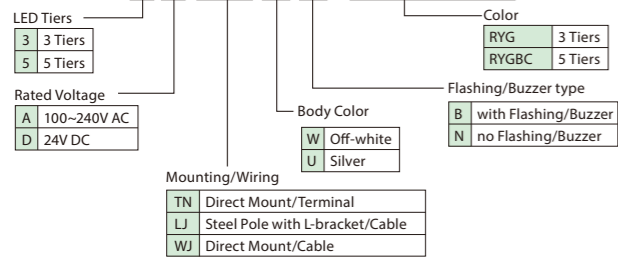

**LA6-POE**

**LA6-5DTNWB-POE**

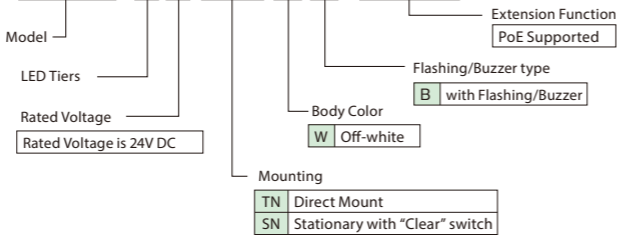

**Specifications**

Model	LA6	LA6-POE			
Rated Voltage	24V DC/100-240V AC (50Hz/60Hz)	24V DC/48V DC (PoE)			
Operating Voltage Range	24V DC ±10%/90-250V AC (50Hz/60Hz)	24V DC±10%/36-57V DC (PoE)			
Rated Power Consumption	Standard	7.2W (24V DC)/8.6W (PoE)			
	LA6-5D□□N-RYGBC		5W	LA6-5D□□B-RYGBC	6.5W
	LA6-3D□□N-RYG		3.5W	LA6-3D□□B-RYG	4.5W
	LA6-5AWJWB-RYGBC		6.5W		
	Maximum				
LA6-5D□□N-YYYY	7W	LA6-5D□□B-YYYY	8W		
LA6-3D□□N-YYY	4.5W	LA6-3D□□B-YYY	5.5W		
LA6-5AWJWB-YYYY	7.5W				
Signal Line Current	Max.70mA (at 24V DC)/Max.20mA (at AC100-240V)	Max. 420mA (at 26.4V DC)/10mA (for PoE)			
Operating Temperature Range	-25°C to +60°C	-10°C to +50°C			
Operating Humidity Range	Less than 90% RH, no condensation	Less than 90% RH, no freezing or condensation			
Mounting Direction	Upright/Inverted	Upright			
Protection Rating	IP65 (with Buzzer: IP54) (IEC 60529)	IP54 (Stationary type: IP20) (IEC 60529)			
Environmental Conditions	Tested while mounted in the upright position				
Mounting Location	Indoors Only				
Insulation Resistance	More than 1MΩ at 500V DC between the power input lead and chassis.				
Withstand Voltage	(500V AC at 24V DC/1500V AC at 100 - 240V AC) for 1 minute between terminals and chassis without breaking insulation.				
Display Color Variations	Signal Mode: 9 colors/Smart Mode: 21 colors				
Buzzer Sounds	11 Sounds				
Sound Level	Maximum 85dB				
Environmental Conditions	Buzzer Sound No.1, in an upright position with a distance from Buzzer opening at 1 meter				
Operation Method	Signal Control	Signal/Command Control			
Standard Compliances	<ul style="list-style-type: none"> <li>24V DC</li> <li>EMC Directive (EN 61000-6-4, EN 61000-6-2), RoHS Directive (EN 50581), UL508, CSA-C22.2 No. 14, FCC Part 15, Subpart B Class A, KC (KN 61000-6-4, KN 61000-6-2)</li> <li>100-240V AC</li> <li>EMC Directive (EN 61000-6-4, EN 61000-6-3), RoHS Directive (EN 50581), Low-voltage Directive (IEC/EN 60947-5-1, EN 62471)</li> </ul>	<ul style="list-style-type: none"> <li>EMC Directive (EN 61000-6-4, EN 61000-6-2, EN55032 Class A, EN 55024, RoHS Directive (EN 50581), FCC Part 15, Subpart B Class A, KC (KN 61000-6-4, KN 61000-6-2), UL 60950-1, CAN/CSA-C22.2 No. UL 60950-1-07, Recognized Component (File No. E480103), * The 24V DC Direct Mount type conforms to the following conformities: UL508, CAN/CSA C22.2 No. 14 Recognized Component (File No. E215660)</li> </ul>			

**Lineup**

Model	Tiers	Voltage	Body Color	Type			
LA6-3DTNWB-RYG	3 Tiers	24V DC	Off-white	Direct Mount/Terminal/Buzzer			
LA6-3DTNWN-RYG				Direct Mount/Terminal/No Buzzer			
LA6-3DWJWB-RYG				Direct Mount/Cable/Buzzer			
LA6-3DWJWN-RYG				Direct Mount/Cable/No Buzzer			
LA6-3DTNWB-RYG				Direct Mount/Terminal/Buzzer			
LA6-3DTNUN-RYG				Direct Mount/Terminal/No Buzzer			
LA6-3DWJWB-RYG			Silver	Direct Mount/Cable/Buzzer			
LA6-3DWJUN-RYG				Direct Mount/Cable/No Buzzer			
LA6-3DLJWB-RYG				L-Bracket with Pole/Cable/Buzzer			
LA6-3DLJWN-RYG				L-Bracket with Pole/Cable/No Buzzer			
LA6-5DTNWB-RYGBC				5 Tiers	24V DC	Off-white	Direct Mount/Cable/Buzzer
LA6-5DTNWN-RYGBC							Direct Mount/Cable/No Buzzer
LA6-5DWJWB-RYGBC	Direct Mount/Terminal/Buzzer						
LA6-5DWJWN-RYGBC	Direct Mount/Terminal/No Buzzer						
LA6-5DTNWB-RYGBC	Direct Mount/Terminal/Buzzer						
LA6-5DTNUN-RYGBC	Direct Mount/Terminal/No Buzzer						
LA6-5DWJWB-RYGBC	Silver	Direct Mount/Cable/Buzzer					
LA6-5DWJUN-RYGBC		Direct Mount/Cable/No Buzzer					
LA6-5DLJWB-RYGBC		L-Bracket with Pole/Cable/Buzzer					
LA6-5DLJWN-RYGBC		L-Bracket with Pole/Cable/No Buzzer					
LA6-5AWJWB-RYGBC		Off-white	Direct Mount/Cable/Buzzer				
LA6-5DTNWB-POE			24V DC or PoE (48V DC)			Direct Mount/Terminal/Ethernet/Buzzer	
LA6-5DSNWB-POE	Stationary/Terminal/Ethernet/Buzzer						

**PATLITE Corporation**

4-1-3, Kyutaromachi, Chuo-ku, Osaka 541-0056 Japan  
 TEL: +81-6-7711-8953 FAX: +81-6-7711-8961 E-mail: overseas@patlite.com.jp

**PATLITE (U.S.A.) Corporation**

20130 S. Western Ave. Torrance, CA 90501, U.S.A.  
 TEL: +1-310-328-3222 FAX: +1-310-328-2676 E-mail: sales@patlite.com

**PATLITE (SINGAPORE) PTE LTD**

No.2 Leng Kee Road, #05-01 Thye Hong Centre, Singapore 159086  
 TEL: +65-6226-1111 FAX: +65-6324-1411 E-mail: sales@patlite.com.sg

**PATLITE (CHINA) Corporation**

Room 1102-1103, No.55, Lane 777, Guangzhong Road (West), Zhabei District, Shanghai, China 200072  
 TEL: +86-21-6630-8969 FAX: +86-21-6630-8938 E-mail: sales@patlite.cn

**PATLITE Europe GmbH**

Am Soeldnermoos 8, D-85399 Hallbergmoos, Germany  
 TEL: +49-811-9981-9770-0 FAX: +49-811-9981-9770-9 E-mail: info@patlite.eu

**PATLITE KOREA CO., LTD.**

A2603, Daesung, D-POLIS, 606, Seobusaet-gil, Geumcheon-gu, Seoul, 08504, Korea  
 TEL: +82-2-523-6636 FAX: +82-2-861-9919 E-mail: sales@patlite.co.kr

**PATLITE TAIWAN CO., LTD.**

7F, No. 91, Huayin St, Datong District Taipei, Taiwan R.O.C  
 TEL: +886-2-2555-1611 FAX: +886-2-2555-1621 E-mail: info@patlite.tw

**PATLITE (THAILAND) CO., LTD.**

Olympia Thai Tower, 15th Floor 444 Ratchadapisek Road Samsenok, Huay Kwang Bangkok 10310, Thailand  
 TEL: +66-2-541-5431 FAX: +66-2-541-5429 E-mail: sales@patlite.co.th

**CAUTION**

To ensure correct use of these products, read the "Instruction Manual" prior to use. Failure to follow all safeguards can result in fire, electric shock, or other accidents. Specifications are subject to change without notice.



**PATLITE ECO PROJECT**

For the benefit of mankind and the earth, Patlite is committed to developing environmentally friendly products.

O-AG06A EN 1710 A

**PATLITE®**  
 New Frontiers in Safety, Security and Comfort.

**Signal Tower**

**LA6 Series**

Sleek Design. Fully Customizable. Endless Possibilities.



**Cycle Time**



**Level Meter Monitoring**



**Status Condition**



**LA6-POE Remote Monitoring**  
 (for Power over Ethernet)



**LA6-POE Ethernet PoE**  
 (Power over Ethernet) for single cable installation

<http://www.patlite.com>

● PATLITE, the PATLITE logo are either registered trademarks or trademarks of PATLITE Corporation in JAPAN and/or other countries.

www.patlite.com

# A SIGNAL TOWER DESIGNED TO SHOW MORE SO YOU CAN DO MORE

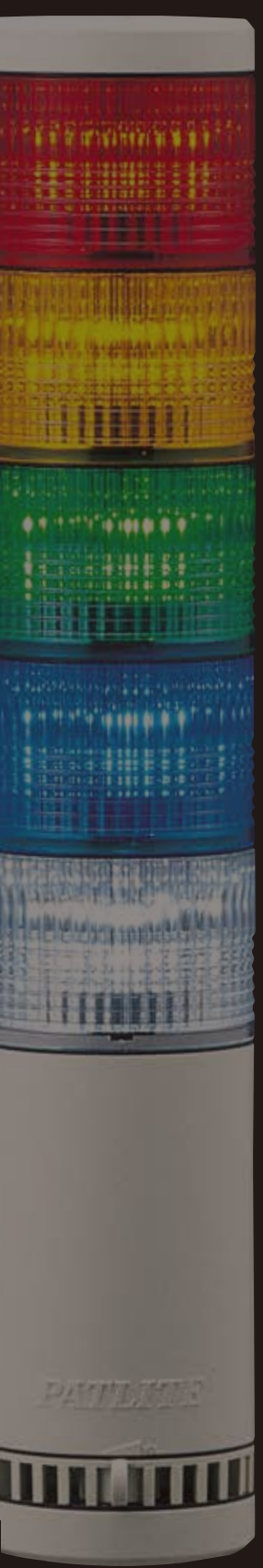

## COMMON ON-SITE OCCURRENCES

### OUR PROCESSES HAVE CHANGED.

We now need to reconfigure the color modules on our Signal Towers.

### OUR MACHINE LINE IS EXPERIENCING TOO MANY STOPPAGES.

We need to make our workers better aware of machine status, so they can take quicker corrective measures.

### WE ARE EXPERIENCING DOWN TIME DUE TO MATERIAL MANAGEMENT.

We need earlier notifications prior to materials completely depleting to avoid delays.

### PRODUCTION STOPPAGES ARE OCCURRING AS A RESULT OF UNEVEN WORKFLOW.

Variations in work output is creating bottlenecks that can be smoothed out with a Takt system.

### WE NEED TO IMPLEMENT REMOTE MONITORING TO MINIMIZE OUR LABOR COSTS.

We need to monitor the operating status of equipment with long processing time, as well as abnormal stoppages or delays as they occur.

## LA6 SOLUTION



### Color Change

The LA6 doesn't require any hardware or wiring changes to reconfigure colors. The LA6 can be easily programmed anywhere without tools.



### Cycle Time

The LA6 is able to create better, more dynamic visual signals to elicit a quicker response by workers.



### Level Meter Monitoring

The LA6 can be programmed to act as a visual level meter to help manage materials and material levels.



### Status Condition

The LA6 has an internal timer function, allowing you to create visual timers for a streamlined Takt system.



### Remote Monitoring

The LA6 is able to send information to other LA6 devices in remote locations via its mirroring function.





# ADVANCED OPTIONS TO SOLVE ANY APPLICATION



**Color Change**

**IMPROVE VISIBILITY WITHOUT RECONFIGURING HARDWARE**



By programming the LA6 to a single, all-tier color arrangement, the equipment status can now be seen at a greater distance, improving awareness and response time.

■ Display up to 21 different colors for different equipment statuses

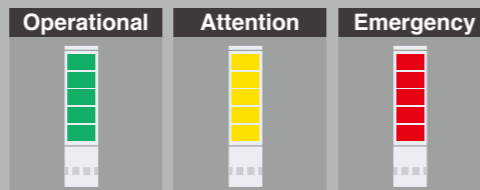

**Level Meter Monitoring**

**REDUCE DOWNTIME WITH LEVEL MONITORING**

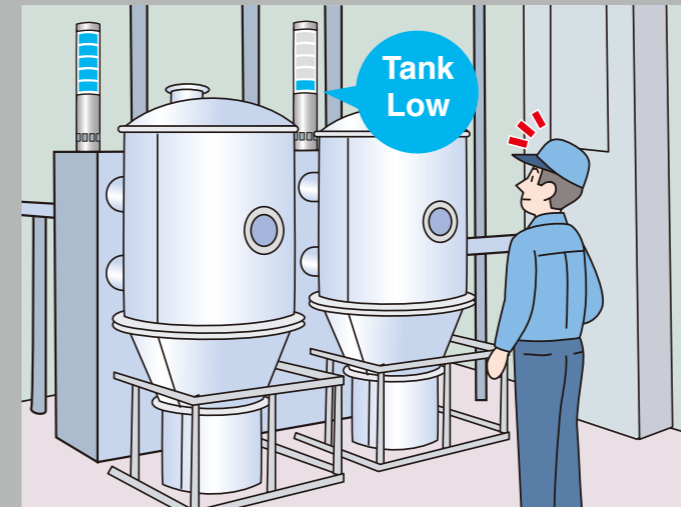

By displaying current material levels, workers can more accurately respond to changes, reducing downtime. As material levels reach certain thresholds, the LA6 can provide earlier visual and audible notifications.

■ Display Remaining tank levels in stages

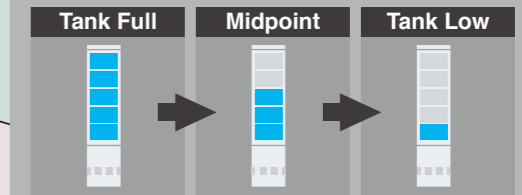

**Status Condition**

**INCREASE EFFICIENCY WITH MORE DYNAMIC VISUAL WARNINGS**

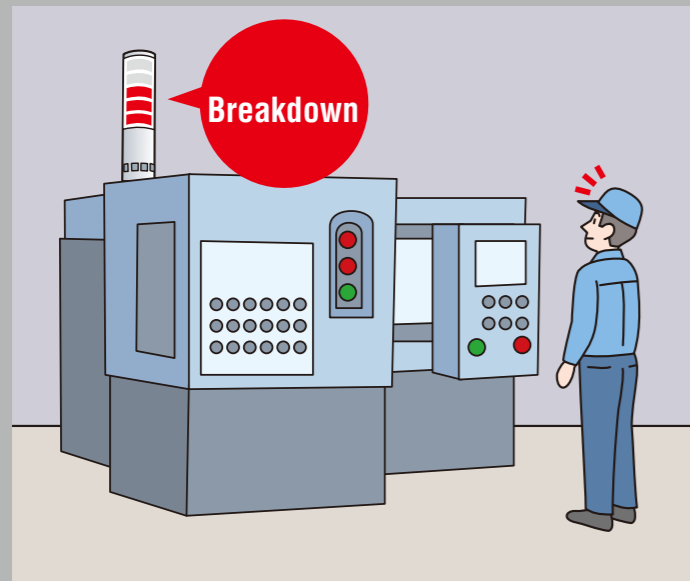

The LA6 is able to display more detailed information, such as the status severity level, or specific abnormality conditions, that workers normally would have to look for on an equipment panel or HMI.

■ Display the level of status severity

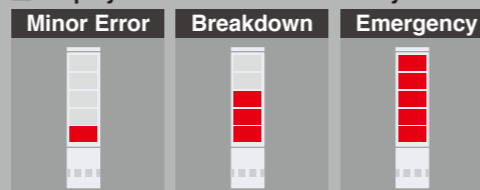

**Remote Monitoring**

**WIRING MADE EASY WITH LAN CONNECTIVITY**

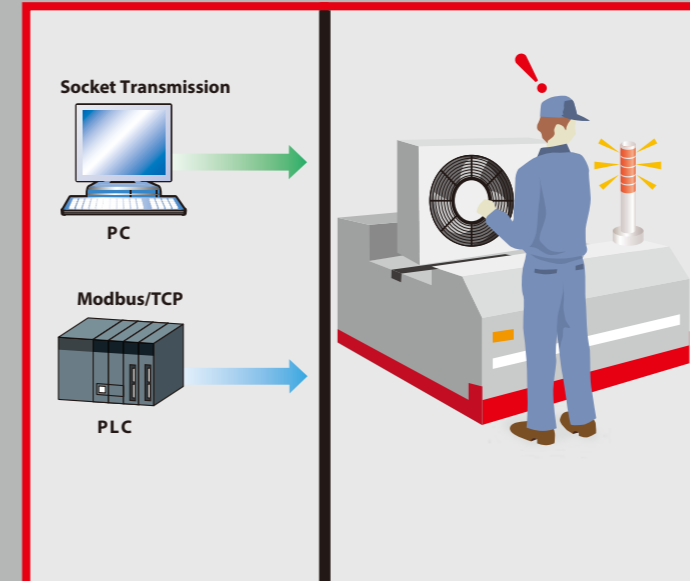

The LA6 conveniently integrates into your facilities' existing LAN infrastructure. By connecting to a PoE (Power over Internet) compliant HUB, the LA6 can be controlled and powered through a single cable.

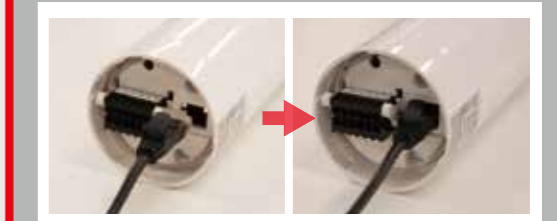

# REDUCE BOTTLENECKS WITH A VISUAL TAKT SYSTEM



## PROBLEM

Idle time or delays on the production assembly line is sometimes caused by variations in the rate of worker output.

## IMPLEMENTATION MERIT

With the LA6 visual Takt system, workers will be more aware of the progress of the entire line, minimizing delays, and resulting in a smoother work flow.

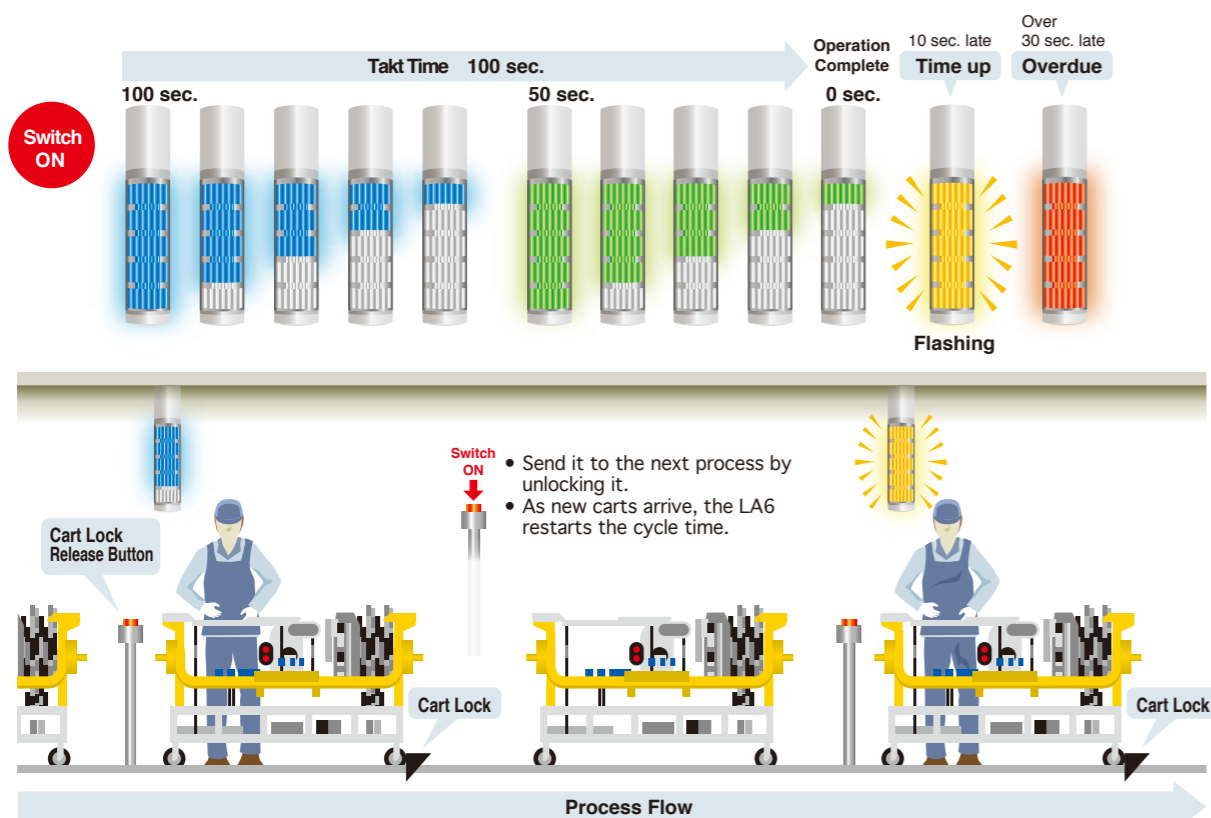

Balance the assembly line with a Takt system



## PROBLEM

Due to high volumes of products to inspect, some defective products may be overlooked and pass inspection.

## IMPLEMENTATION MERIT

With the LA6 internal timer function, inspectors are allotted proper time for each inspection, resulting in an improved yield rate by accurately detecting inferior goods.

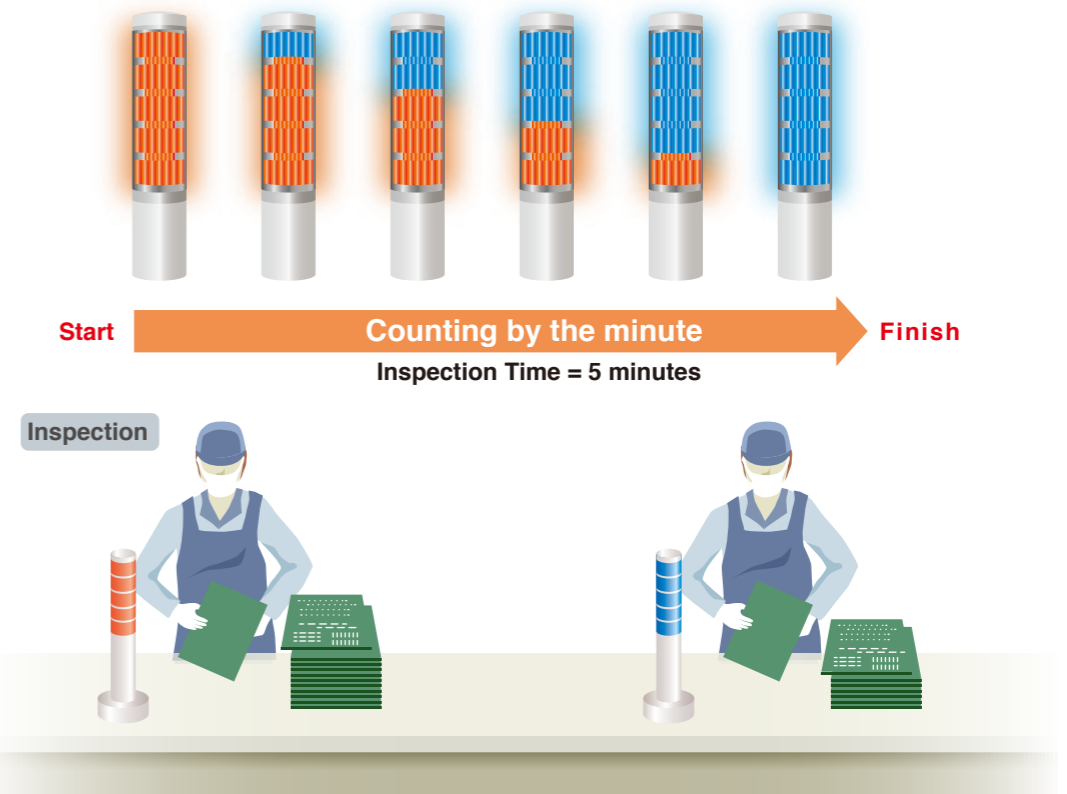

Sensors detect inspectors as they enter the process line, triggering the LA6 to begin the count and the inspectors carry out inspection until the LA6 turns all blue.

Prevent defective product outflow during inspection

# OBTAIN EQUIPMENT INFORMATION FROM REMOTE LOCATIONS



## PROBLEM

Tanks located in remote buildings tend to be overlooked until the tanks are completely depleted.

## IMPLEMENTATION MERIT

The LA6 can be used as an economical level meter system, capable of alerting remote personnel of equipment changes in real-time.



## PROBLEM

Managers in remote offices need to monitor machinery statuses on the factory floor in real-time.

## IMPLEMENTATION MERIT

With the LA6-POE's built-in mirroring function, equipment status, Takt time, etc., can be communicated to other LA6-POE devices in remote locations via a LAN connection. This data can also be sent to a third-party software through the LAN connection for data analysis or Andon monitoring.

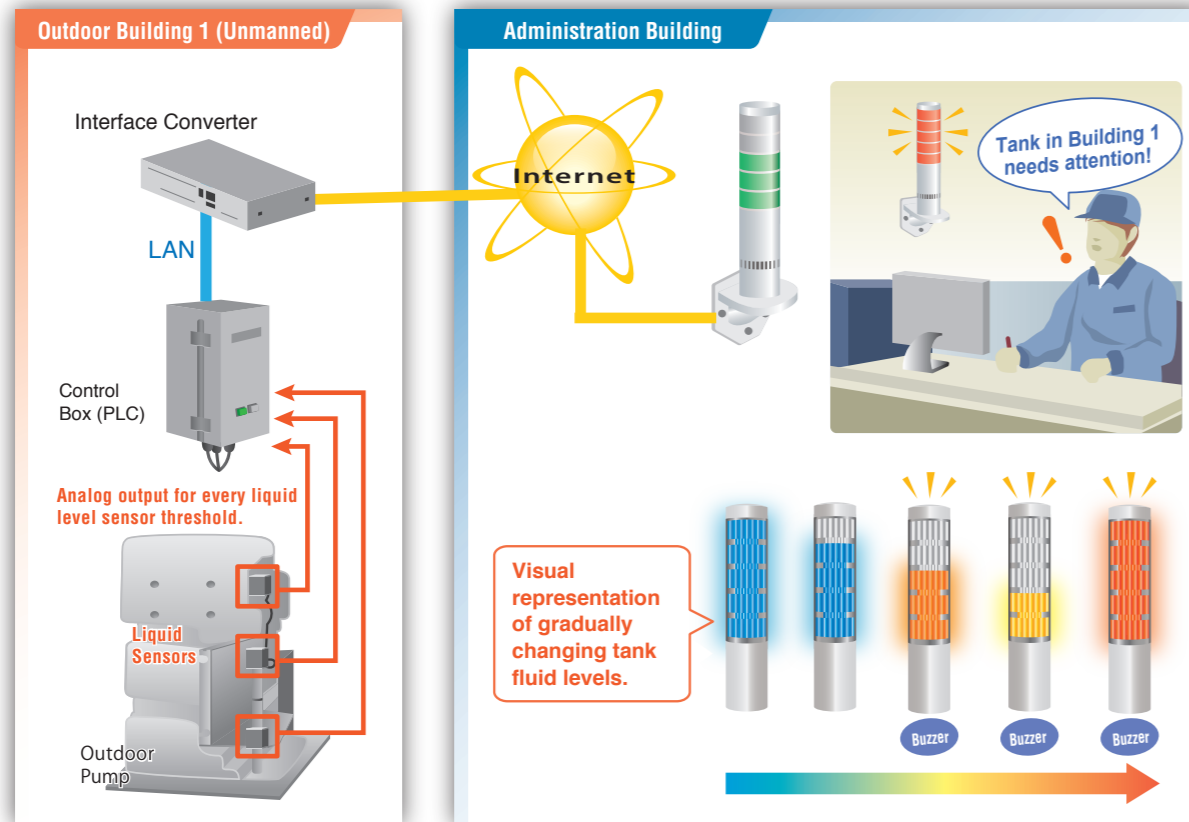

Quicker response with remote monitoring

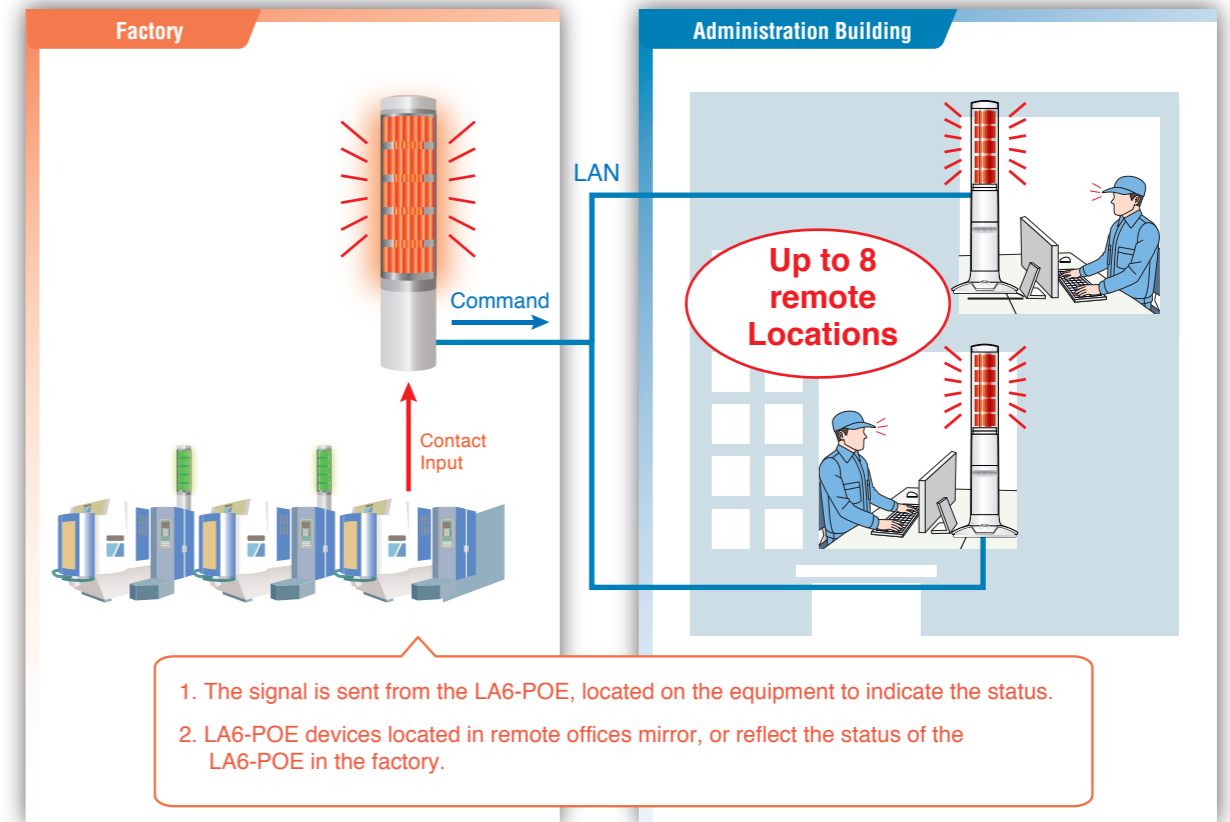

See equipment status from multiple locations

# LA6 SIGNAL TOWER



### Multi-function Switch for various setups

#### BUZZER SOUND SETUP

The built-in switch has four selectable settings for "Loud" (about 85dB) -> "Middle" (about 80dB) -> "Low" (about 75dB) -> "Off".

#### COLOR SETUP

The built-in switch can also allow a manual selection of 9 colors to be set for each tier.



### A new lens design optimizes visibility.

The newly developed lens design efficiently diffuses LED light so that it is unmistakably visible, even from great distances.

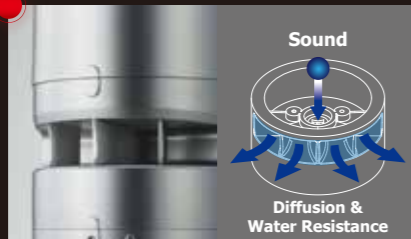

### The alarm has a total of 11 sounds to match various applications.

A newly developed compact loudspeaker not only can transmit a clear sound of 85 dB (at 1m), but also has added water resistance. A different alarm sound can be set up with each display pattern when in the Smart mode. (Only three of the 11 alarm patterns are selectable in the Signal Tower mode)



### Use the free editing software to freely change the LA6 colors and patterns.

Upload colors and patterns to the signal tower via a USB cable.\*  
\* The USB cable is sold separately (USB microB type with Charging/ Data Transfer capability).



### Conveniently connects to an existing network with PoE support.

PoE (Power over Ethernet) is a technology which lets network cables carry electrical power. PoE can bring many advantages, such as reducing costs of installing electrical cabling, by connecting it with a HUB supporting PoE, or have the flexibility of not having to be tethered to an electrical outlet.



### Detachable Terminal Block

Has eight inputs available for connecting a PLC, or discrete I/O. Data through these inputs can be transferred to a server over the Ethernet. DC power can also be wired if a PoE supporting LAN is not available.



## LA6 24V DC / 3 and 5 Tier Types

## LA6 100 - 240V AC 5 Tier Types

The LA6 alarm features a total of 11 sounds to match various applications.



Off-white  
Flashing/Buzzer



Silver  
Lighting



Steel Pole Type (LJ)



Off-white  
Flashing/Buzzer

Voltage: 24V DC  
Direct Mount/Terminal (TN)  
Steel Pole with L-bracket/Cable (LJ)

Voltage: 100-240V AC  
Direct Mount/Cable (LJ)

24V DC 100 - 240V AC

85dB (at 1m) Buzzer 11 Sound

IP65\* Φ60 RoHS

\* Alarm Type: IP54

## LA6-POE Direct Mount / Stationary type

NEW



Direct  
Mount type



Stationary Type  
with "Clear" switch

PoE 85dB (at 1m) Buzzer 11 Sounds Ethernet Modbus /TCP EASY WEB Setup

24V DC 48V DC (PoE) HTTP INPUTS IP54\* Φ60 RoHS

\* Direct Mount Type

### PNS Command

By using a PNS Command, the LED unit colors for tiers 1-5 can be controlled.

### HTTP Command

Access and control all LA6-POE functions remotely in various network environments with this flexible protocol.

### Modbus / TCP

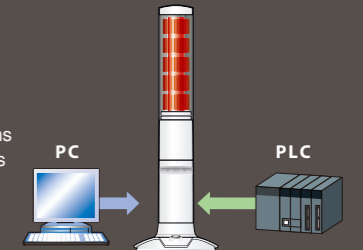

3rd Party Software: LA6-POE can send machine status data over Ethernet to centralized software for remote Andon monitoring or data analysis.

## LA6 / LA6-POE Optional Parts

For LA6/LA6-POE



Stationary Bracket:  
SZK-003W  
Direct Mount type

For LA6



Mounting Pole  
with L-Bracket:  
SZ-70L



Circular Bracket:  
SZ-010



Circular Bracket:  
SZ-016A

For LA6-POE



Stationary Bracket:  
(Magnetic Mount)  
Model: SZW-060W  
Direct Mount type



Wall Mount Bracket:  
Model: NH-WST2  
Stationary type



Editing Software  
**Free**

# Simple program software! Download and easily set up PATLITE's exclusive editing software.

LA6 SERIES

## Easy Setup

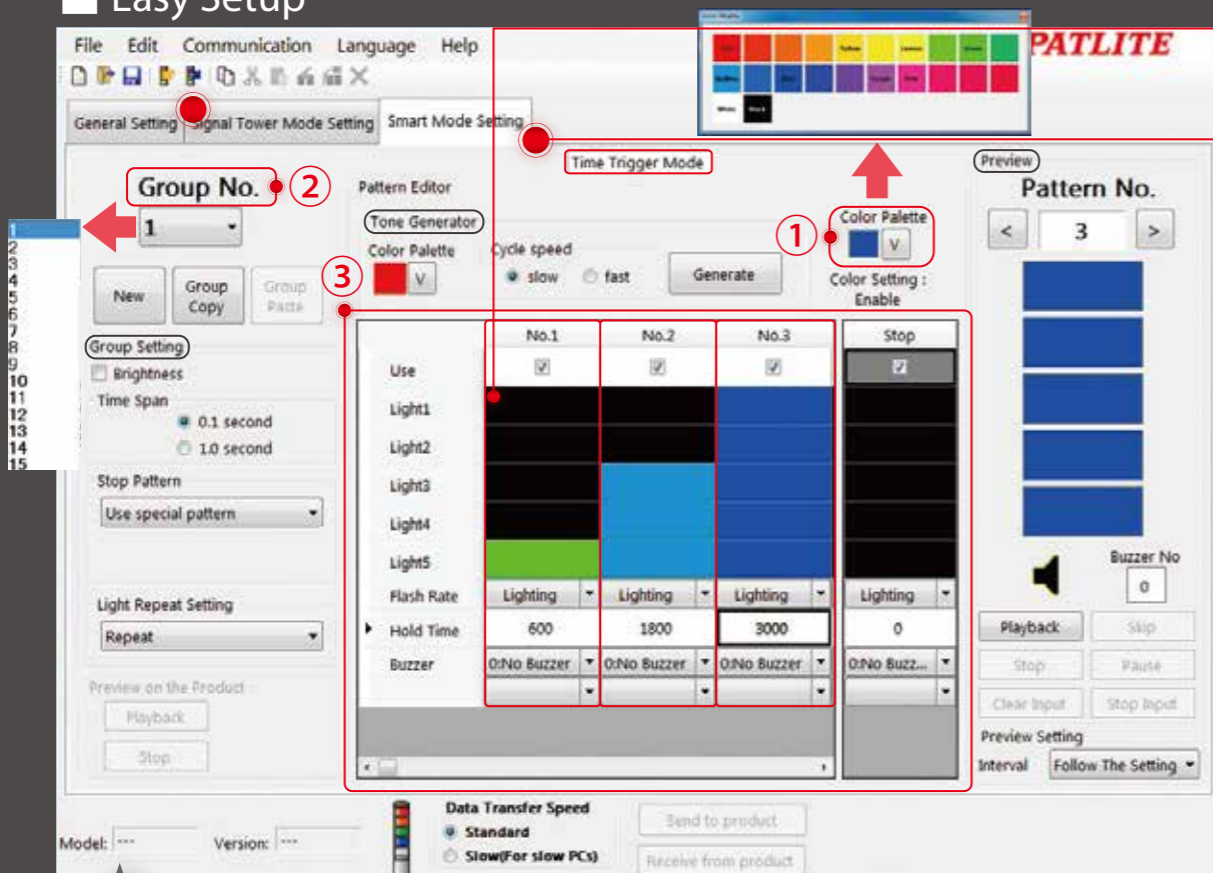

\* The screen above is only an image (conditions may vary with setup parameters).

### ① Color Setup (Maximum of 21)

21 different colors can be selected as part of a program.

### ② Signal Tower Setup Features

With a maximum of 15 groups\*, 63 series of operations can be registered to perform an operation setup as one group.

\* A single display type can register a maximum of 31 groups.

### ③ Operations (Maximum of 63)

Select the desired color, flashing period and the active duration of the light and alarm\* (maximum of 3,600 seconds, and 11 sounds).

\* Limited to Time Trigger and Pulse Trigger modes

### ● Various Setups

#### ○ Group setup (Detailed Settings)

- Flash Reduction Setup
- Time Span (0.1 sec./1.0 sec.)
- Repetitive Lighting Setup

#### ○ Sign pattern generation (9 colors)

- Generate colors as gradations or chaser lights.
- Color select: Cycle Speed (Low/High)

#### ○ Simulation

- Check the light pattern by previewing it before transmitting data into the unit.

#### ○ System Transmit and Receive\*

- Data can be written into the unit and also read from it, so that patterns can be easily copied into other units.

\* Data transfer is also possible when the main unit is OFF and the system's power source is the USB bus power.

## Smart Mode



Elapsed Time / Countdown / Cycle Time

### 1. Time-trigger Type

Setups for the individual group operation can be executed. Pattern change timing can be setup with the editing software.

Maximum pattern display	63 Patterns
Maximum group number	15 Groups

Setup timing in pattern changes with the editing software.

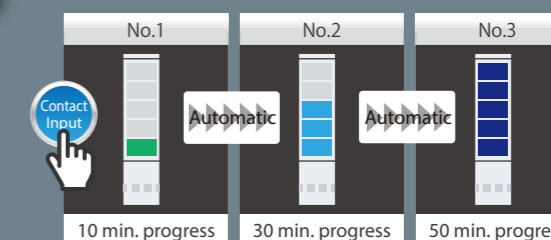

Determine thresholds for pressure / temperature, etc.

### 2. Pulse-trigger Type

Transitions from one pattern to another can be triggered by setting elapsed time or by individual discrete inputs.

Maximum pattern display	63 Patterns
Maximum group number	15 Groups

Pattern transition timing can be controlled by individual discrete inputs.

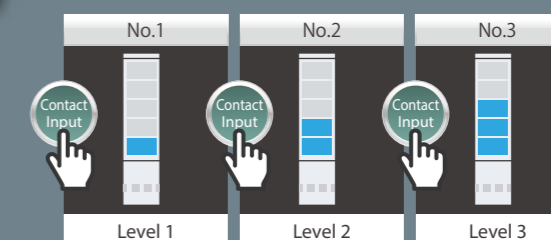

Error level / Request Priority / Status Display, etc.

### 3. Single-display Type

The product memory operates for the individual group functions.

Maximum pattern display	—
Maximum group number	31 Groups

Inputs 1-5, with ON/OFF signal combinations, is made to operate.

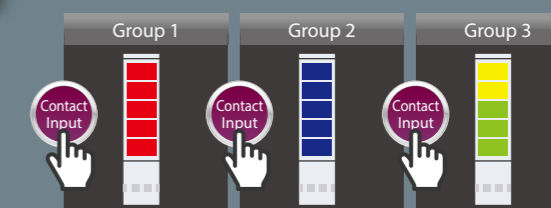

## Signal Tower Mode



Colors can be configured manually with the push button, without the need to edit the software.

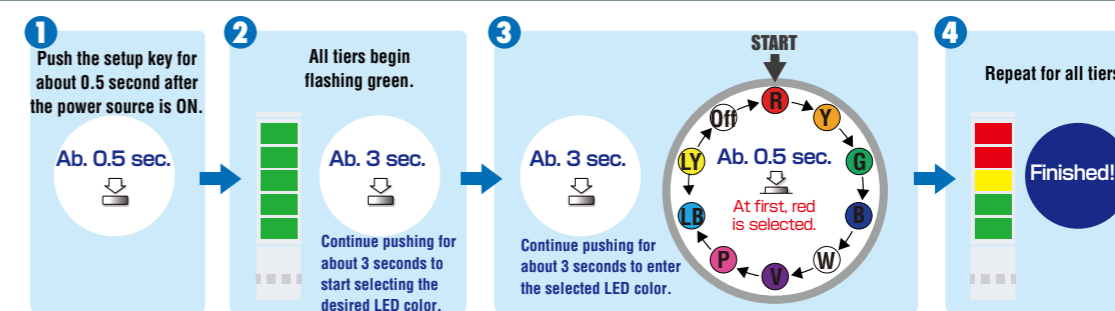

<http://www.patlite.com>

patlite Search

Editing software and pre-set data patterns are downloadable for free from our website.

# DIMENSIONS AND WIRING

## Outer Dimensional Drawings

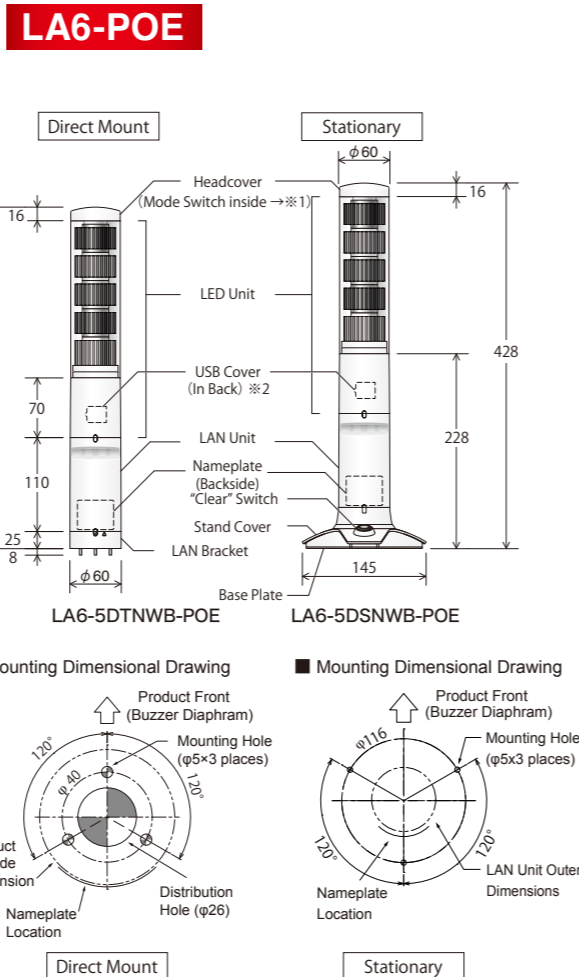
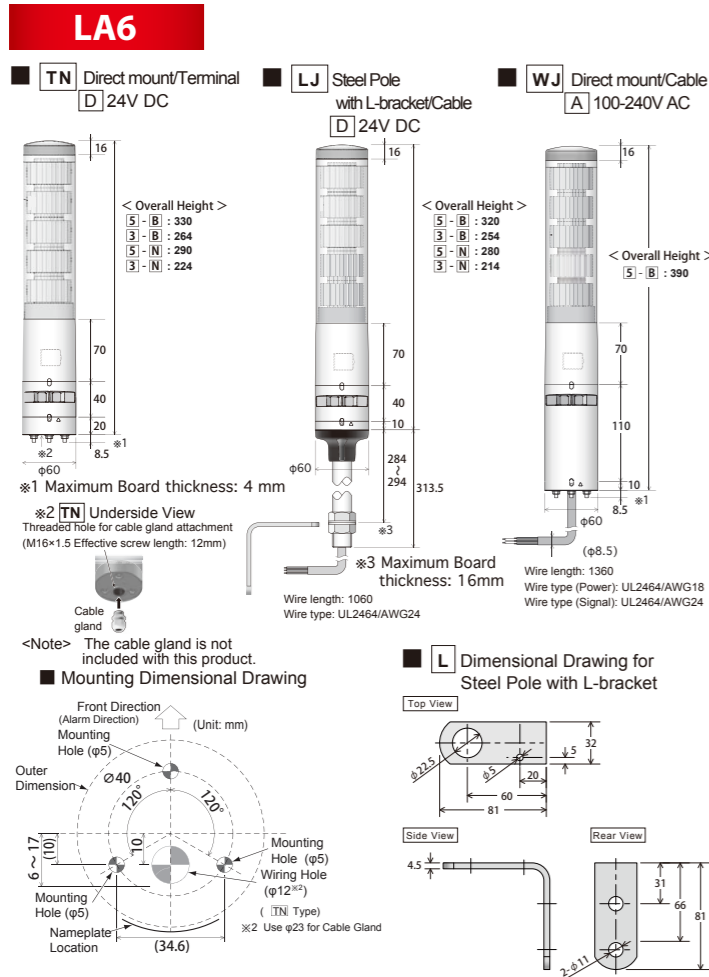

## Connector Inputs

### LA6 (Terminal Type)



### LA6-POE

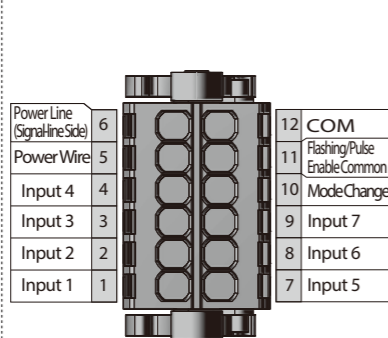

## Smart Mode Inputs (for Mode Change)

	① Time-trigger Type	② Pulse-trigger Type	③ Single-display Type
Input1 <b>Red</b>	Display Input (Binary Input Maximum 15)	Display Input (Binary Input Maximum 15)	Display Input (Binary Input Maximum 31)
Input2 <b>Amber</b>			
Input3 <b>Green</b>			
Input4 <b>Blue</b>			
Input5 <b>White</b>	STOP	Trigger	
Input6 <b>Purple</b>	Mute	Mute	Mute
Input7 <b>Sky Blue</b>	Clear	Clear	Clear
Mode Change <b>Pink</b>	At Input		

It can be used for the smart mode when a signal is applied to the mode change line.

\* For connector inputs, mode change is terminal 11 purple; and terminal 10 for the PoE type.

## Wiring

Red indicates the lead wire color (for Cable type models) \* The lead wire color does not indicate the LED luminescence color.

### 24V DC Wiring (LA6/LA6-POE)

\* Be sure to check the wiring diagram of the PNP type transistor by visiting our website and viewing the comprehensive operation manual, etc.

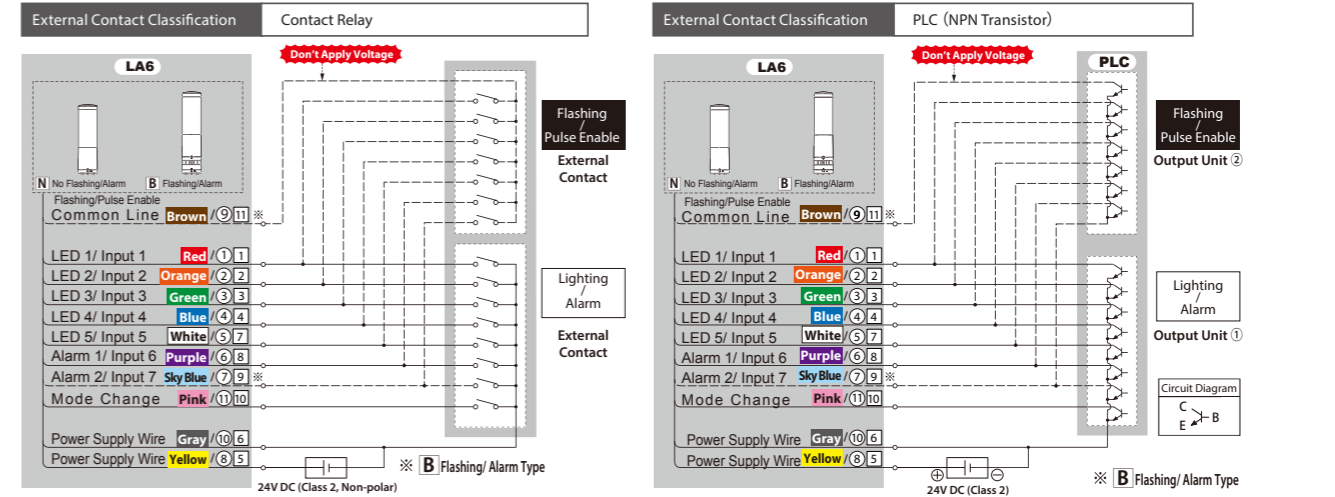

### 100 - 240V AC Wiring (LA6)

\* Be sure to visit our website and viewing the comprehensive operation manual, etc. for further details.

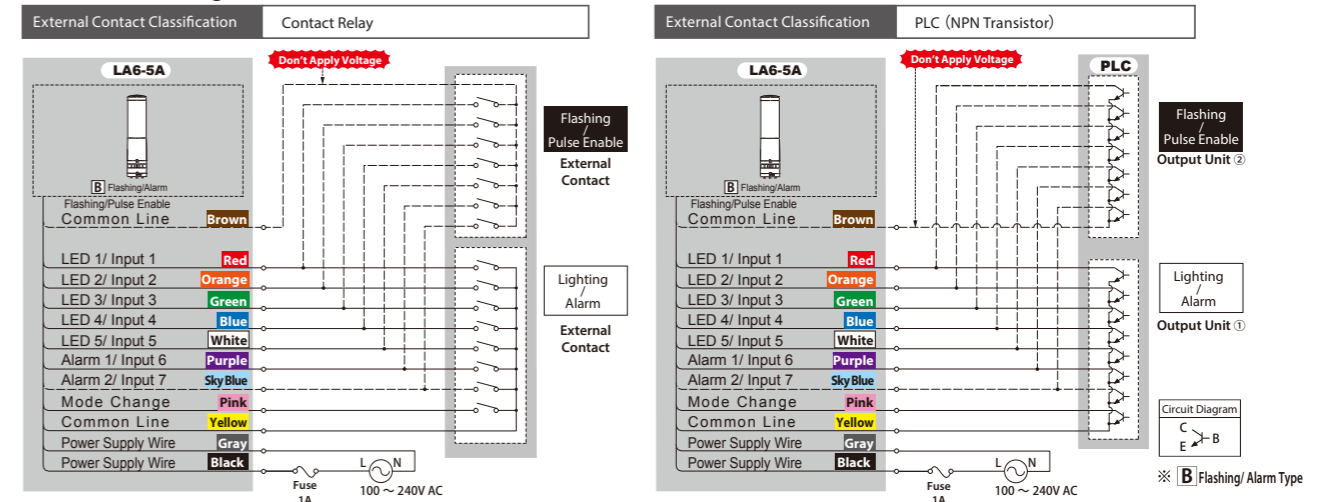

### POE Wiring (LA6-POE)

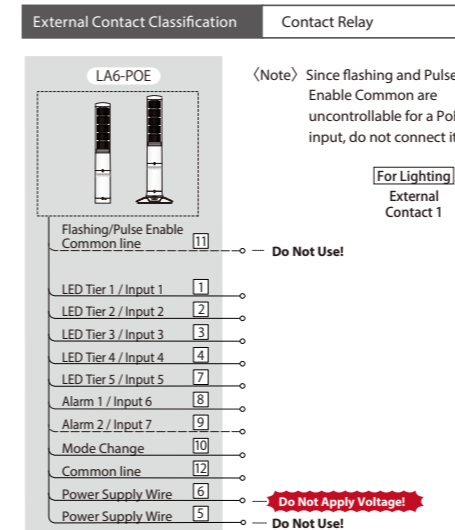

### Wiring Diagram color and number indication

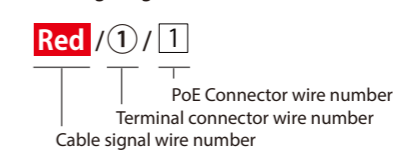

### LAN Cable Connection

The LAN cable should be rated for category 5e or higher. A straight or cross cable can be used.

- MEMO
- Be sure to use the IEEE802.3af compliant products for the PoE power feeder systems.
  - Priority is given to the 24V DC power supply when both the 24V DC power source and PoE power feeder systems are connected simultaneously.
  - If both power sources are simultaneously connected, when disconnecting the 24V DC source, this product may reboot.