

Interface Converter  
**NBM Series**  
**User's Manual**

**Supported Models**  
**NBM-D88N**



# Introduction

Thank you for purchasing the PATLITE "NBM-D88" (henceforth, written as "this product") Interface Converter. Before installation and use, please read this manual (henceforth referred to as "this book") and follow the cautions and guidelines presented. In addition, store this manual for future reference when performing maintenance, repairs or inspections. When performing maintenance and repairs, etc., be sure to reread this book.







In addition, if there are any questions concerning this product, feel free to contact your PATLITE Sales Representative indicated at the end of this book.

## Notice

- The copyrights of this book is owned by the PATLITE Company, Inc. (henceforth referred to as "our company"). Any reproduction, duplication, alteration, or extracting portions of this book, etc., without written permission from our company is forbidden.
- Specifications, the design, and other contents written in this book may be changed for improvements without prior notice and may result in differences from the actual product purchased.
- This product meets severe quality control and inspection requirements prior to shipment, but if some failure or defect is found, please contact the place of purchase, or your PATLITE Sales Representative (indicated on the last page) to solve the issue.
- Please understand that our company does not take any responsibility for damage and other disadvantages this product (software is included) has caused due to the customer using this product outside its designed application, such as for home, office and industrial use, high security applications such as medical or systems related to human life, directly or indirectly, or from claims from any third parties.
- Also understand, prior to use, no responsibility is taken at our company for damages or other disadvantages, due to customers use of this product beyond the scope of its general application, or from any claims made from third parties.
  - When using this product for applications in which equipment of higher reliability than the general application demands, such as a computer system, etc., please use suitable safety design countermeasures against system failure, etc.
- Please understand that our company does not take any responsibility for damage and other disadvantages this product (software is included) has caused due to the customer using this product, or any claims from third parties.
- This product has been tested and found to comply with the limits for a Class A device, pursuant to EMC DIRECTIVE.
- These limits are designed to provide reasonable protection against harmful interference when the equipment is operated in a commercial environment.
- This product must not be used in residential areas.
- An AC Adaptor with UL listings is required, in order for this product to comply with UL certifications.
- This product contains no contents of controlled substances which exceeds the threshold of the RoHS Directive.







## For safe application, observe the following:

The following symbols classifies the following into different categories and explains the level of harm inflicted if the cautions are disregarded.

 <b>WARNING</b>	Indicates an imminently dangerous condition: failure to follow the instructions may lead to death or serious injury.
 <b>CAUTION</b>	Indicates a potentially dangerous condition: Failure to follow the instructions may lead to slight injury or property damage.
 Prohibited	This symbol indicates "Prohibited", which should not be carried out by all means.
 Enforced	This symbol indicates "Enforced", which should be observed and carried out by all means.
 <b>Attention</b>	Indicates something to observe before using this product.
 <b>MEMO</b>	Notice regarding supplementary information or convenient explanation is indicated

## Cautionary Notes

Prior to installation, read all notes and use this product correctly.

 <b>WARNING</b>	
 Prohibited	<ul style="list-style-type: none"> <li>• Do not disassemble or alter the product. Failure to comply may result in fire, electric shock, or failure.</li> <li>• Do not touch the electric socket with wet hands. It may result in electric shock.</li> <li>• Do not allow the voltage to exceed the specified voltage tolerance. Exceeding the voltage ratings beyond the rated voltage will cause internal circuitry damage. Moreover, possible fire may also occur.</li> <li>• After attaching this product onto the machinery, Do not remove the cover, hook anything onto the product or use the product as a step when climbing onto the machinery. Failure to comply may result in falling off the machinery or product damage may occur.</li> </ul>
 Enforced	<ul style="list-style-type: none"> <li>• Do not disconnect and re-insert the DC plug while the AC Adaptor is plugged in. Possible electric shock and damage may occur.</li> <li>• When plugging into the power receptacle, be sure to check there is no dust accumulation on the plug, and insert into the power receptacle completely. By allowing dust to adhere, it can be the result of fire or failure from short-circuiting.</li> <li>• Since dust can accumulate After a long time, and with moisture, can cause the dust to become conductive, in order to prevent the phenomenon of ignition from dust accumulation, it is best to periodically wipe the transformer and socket terminal with a damp cloth. By allowing dust to adhere to the power receptacle, it can be the result of fire or failure from short-circuiting.</li> <li>• When installing, wiring, or replacing parts, be sure to turn off the power first to prevent electric shock.</li> <li>• When an unusual odor, sound or smoke comes out of the product, immediately disconnect the power, then contact your nearest PATLITE Sales Representative.</li> </ul>
 <b>CAUTION</b>	
 Enforced	<ul style="list-style-type: none"> <li>• Place this product on a level surface, such as a desk etc.</li> <li>• When installing in high places, such as a top shelf, fix the Main Unit so it cannot move or fall.</li> </ul>
 Prohibited	<ul style="list-style-type: none"> <li>• Do not expose it to high temperatures, such as near a fire and do not use it in humid places. Moreover, do not use this machine in locations where corrosive or combustible gas is present.</li> <li>• If foreign substances, such as water, medicine; or metals, such as copper, low carbon steel wire, fall into this product, please do not use it. Possible cause of failure may occur.</li> <li>• Do not disassemble or attempt to repair this product by any means. Failure to comply will result in equipment damage or fire.</li> <li>• Do not bend the power supply cables or signal wires recklessly. Failure to comply will result in possible malfunction due to disconnection.</li> <li>• Do not install or run wiring near, or where equipment (such as solenoids, etc.) generate strong electric or magnetic fields, or near any power lines. Failure to comply may result in malfunction due to inductive noise.</li> <li>• Do not place any part of this product (Main Unit, terminal cover, AC Adaptor, rubber feet) where infants can reach it. If it is swallowed accidentally, it could be detrimental. If it is suspected of being swallowed, please consult an emergency medical center immediately.</li> </ul>

## Registered Trademarks

Microsoft, Windows, Internet Explorer, and Microsoft Edge are registered trademarks of Microsoft Corporation in the United States and other countries.

Firefox is the trademark or registered trademark in the U.S. and other countries for the U.S. Mozilla Foundation.

Google Chrome is a trademark or registered trademark of Google LLC in the United States and other countries.

In addition, company and product names indicated are the trademark, or registered trademark for each company.

## Product Checklist

The following items are contained with this product. Although our company takes all possible quality control measures to ensure proper packing of this product, if there should be any missing items, please refer to the last page to contact your nearest PATLITE Sales Representative.

- NBM-D88 Main body (one unit)
- Setup Manual (one book)
- Rubber Feet (4 pieces)

# Table of Contents

## Introduction

<b>1.</b>	<b>Product Outline</b>	<b>9</b>
1.1	Dimensional Drawing	9
1.1.1	Main Unit	9
1.2	AC Adaptor Specifications	9
1.3	Part Names	10
1.4	Model Number Configuration	10
1.5	General Specifications	11
1.6	Functionality Description	12
1.6.1	Monitoring Function	12
1.6.2	Communication Commands	12
1.6.3	Communication Function Setup	13
1.6.4	Setup and Updates	13
<b>2.</b>	<b>Installation Procedure and Flowchart</b>	<b>14</b>
2.1	Installation Procedure and Flowchart	14
2.2	Product Installation	15
2.2.1	Placing in an unfixed location	15
2.2.2	When using the Server Rack Mounting Bracket (Optional)	16
2.3	LAN Connection	17
2.4	Terminal Buss Wiring	17
2.4.1	Input Terminal and Output Terminal Mount Wiring	17
2.4.2	Power Output Terminal Wiring	18
2.5	Power Supply Input	19
2.6	Network Setup	20
2.6.1	Login	20
2.6.2	Setting the IP Address	22
2.6.3	Setup Confirmation	23
2.7	Network Setup with the DHCP Function	24
2.8	Clock Settings	25

## **3.    Functionality Details**

**26**

---

<b>3.1</b>	<b>Digital Input/Output Function</b>	<b>26</b>
3.1.1	Digital Contact	26
3.1.2	Digital Input Monitoring Function	27
3.1.3	Digital Input Circuit Diagram	28
3.1.4	Digital-Output-Control Function	28
3.1.5	Automatic Digital Output OFF Function	29
3.1.6	Digital Output Part Graphical Diagram	30
<b>3.2</b>	<b>Test Functions</b>	<b>30</b>
<b>3.3</b>	<b>SNMP Function</b>	<b>31</b>
3.3.1	SNMP SET Digital Output Control Function	31
3.3.2	SNMP GET Digital-Input/output Status Acquisition Function	31
3.3.3	Trap Reception Function	31
3.3.4	Trap Transmission Function	31
<b>3.4</b>	<b>PHN Command Reception Function</b>	<b>32</b>
<b>3.5</b>	<b>PNS Command Reception Function</b>	<b>33</b>
<b>3.6</b>	<b>Mail Transmission Function</b>	<b>35</b>
3.6.1	E-mail Message Contents	35
<b>3.7</b>	<b>RSH Command Function</b>	<b>36</b>
3.7.1	RSH Command Reception	36
3.7.2	RSH alert Timer Reset Function	39
3.7.3	RSH Command Transmission Function	39
<b>3.8</b>	<b>Socket Transmission Function</b>	<b>40</b>
<b>3.9</b>	<b>Ping Monitoring Function</b>	<b>41</b>
3.9.1	Ping Monitoring Function	41
3.9.2	Ping Monitoring Function ("Clear" Command Outside Sources)	42
<b>3.10</b>	<b>Application Monitoring Function</b>	<b>43</b>
<b>3.11</b>	<b>Status Clear Function</b>	<b>44</b>
<b>3.12</b>	<b>"Clear" Switch Function</b>	<b>44</b>
<b>3.13</b>	<b>Digital Input Condition Setup Function</b>	<b>45</b>
<b>3.14</b>	<b>Reinitialization Function</b>	<b>46</b>
<b>3.15</b>	<b>Configuration Data Save/Load Setup</b>	<b>47</b>
<b>3.16</b>	<b>Status Log Function</b>	<b>47</b>
<b>3.17</b>	<b>Operation Log Function</b>	<b>48</b>

3.18	Firmware Update Function	49
3.19	XML Data Output Function	49
3.20	USB Memory Function	50
3.21	Mode Switching Functions	51
3.22	"Reset" Function	58
3.23	HTTP Command Control Function	59
3.23.1	Example	59
<b>4.</b>	<b>Function Setup</b>	<b>60</b>
<hr/>		
4.1	System Configuration Screen	61
4.2	User Authorization Configuration Screen	62
4.3	Clock Settings Screen	63
4.3.1	PC Clock Synchronization	64
4.3.2	Synchronizing with an NTP server	65
4.3.3	Setting Time Zone	65
4.4	SNMP Configuration Screen	66
4.4.1	SNMP SET/GET	66
4.4.2	SNMP Trap Reception	66
4.4.3	SNMP Trap Transmission	66
4.5	E-mail Settings Screen	67
4.6	E-Mail Message Settings Screen	69
4.7	RSH Command Transmission Configuration Screen	70
4.8	RSH Command Reception Configuration Screen	71
4.9	Socket Transmission Configuration Screen	72
4.10	Socket Reception Configuration Screen	73
4.11	Digital Input Setup Screen	74
4.12	Digital Output Setup Screen	76
4.13	Trap Reception Configuration Screen	77
4.14	Application Monitoring Configuration Screen	80
4.15	Ping Monitoring Configuration Screen	82
4.16	"Clear" Button Setting Screen	84
4.17	Digital Input Condition Settings Screen	85
4.18	Reinitialization Setup Screen	89
4.19	Reboot Screen	90
4.20	Digital Output Operation Screen	91

4.21	"Clear" Operation Screen	92
4.22	Firmware Update Screen	93
4.23	Configuration Data Setup Screen	94
4.24	Status Log Screen	95
4.25	Event Log Screen	96
4.26	XML Settings Screen	97
<b>5.</b>	<b>MIB</b>	<b>98</b>
<hr/>		
<b>6.</b>	<b>Replacement and Option Parts</b>	<b>101</b>
<hr/>		
6.1	Replacement Parts List	101
6.2	Option Parts	101
<b>7.</b>	<b>Maintenance and Inspection</b>	<b>102</b>
<hr/>		
<b>8.</b>	<b>Troubleshooting</b>	<b>103</b>
<hr/>		
<b>9.</b>	<b>Conditions for Freeware Utilization Consent</b>	<b>106</b>
<hr/>		
9.1	GNU GENERAL PUBLIC LICENCE	106
9.1.1	Version 2.0	106
9.2.2	Version 3.0	110
9.2	GNU LESSER GENERAL PUBLIC LICENSE	119
9.3	NET-SNMP	121
9.4	BSD LICENCE	124



# 1. Product Outline

## 1.1 Dimensional Drawing

### 1.1.1 Main Unit

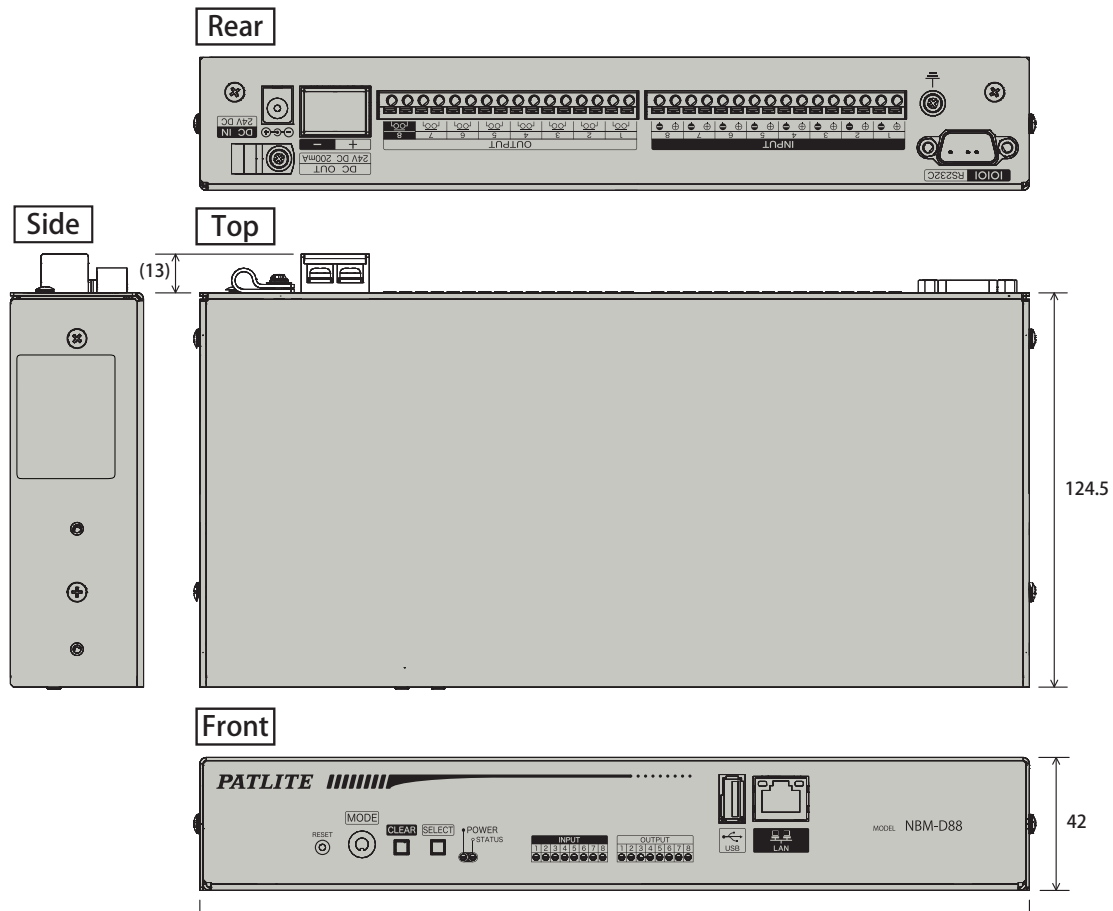

## 1.2 AC Adaptor Specifications

When ordering an AC Adaptor separately, use the following specifications.  
Failure to comply may result in failure of this product.

### [Recommended AC Adaptor Specifications]

#### DC Secondary Output

- Voltage : 24V DC  $\pm 5\%$
- Current : 0.75A to 1A max.
- Plug Length : 9.5mm or more.
- Plastic Housing : 10mm dia or less.
- Plug Connector Outer Diameter : 5.5mm dia.
- Plug Connector Inner Diameter : 2.1mm dia.

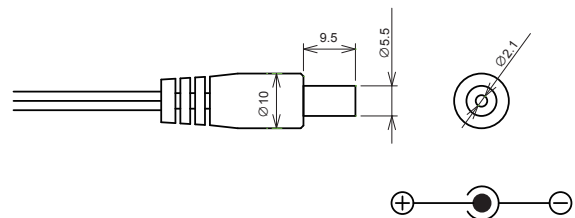

### 1.3 Part Names

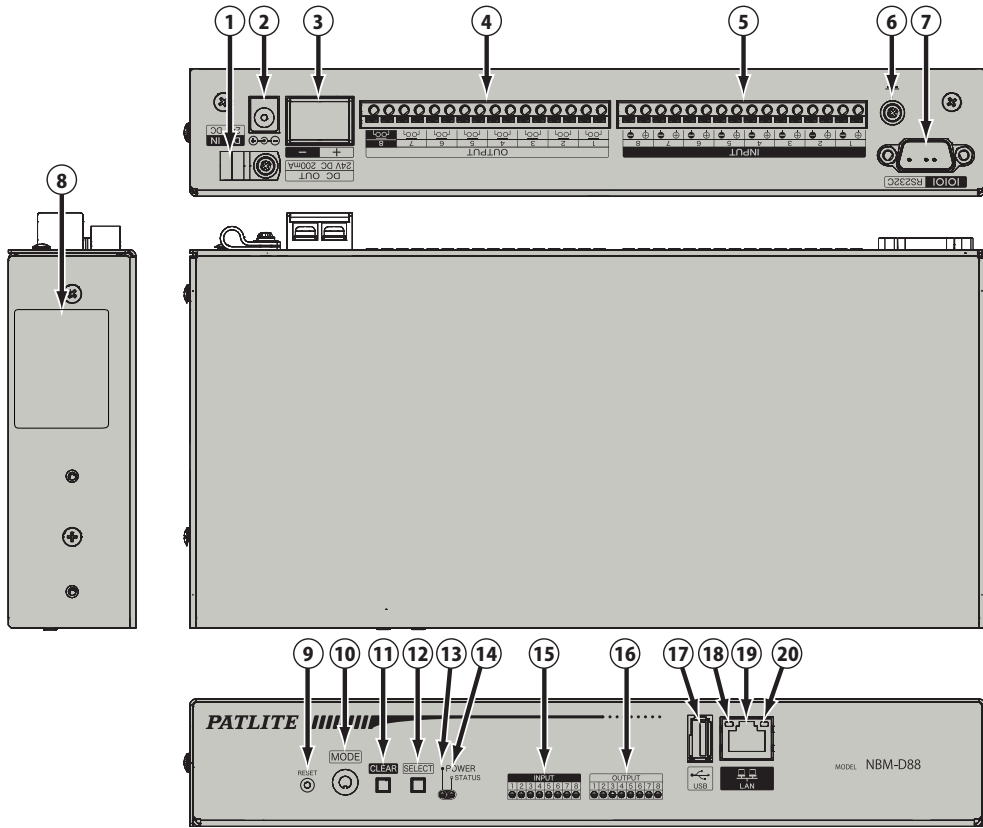

Number	Name	Number	Name
1	Cable Clamp	11	"CLEAR" Button
2	DC Jack	12	Select Switch
3	Power Output Terminal	13	Power LED
4	Output terminal	14	Status LED
5	Input terminal	15	Input Indication LED
6	Functional Earthing	16	Output Indication LED
7	D_SUB_9pin	17	USB Connector
8	Nameplate	18	LINK Indication
9	"Reset" Switch	19	LAN Connector
10	"Mode" Switch	20	ACT Indication

### 1.4 Model Number Configuration

Model No.	Model	Input Type	AC Adaptor
	NBM-D88	N	N

**N** AC Adaptor Not included

**N** NPN Transistor (Non-voltage Contact)

1

## 1.5 General Specifications

Item	Specifications	
Model	NBM-D88NN	
Main Unit Rated Voltage	24V DC	
Rated Current Consumption	0.6A	
Operating Temperature Range	0 - 40°C (No freezing, dew or condensation)	
Storage Temperature Range	-20 - 65°C (No freezing)	
Operating Humidity Range	20 - 80% RH (No freezing)	
Vibration Resistance	9.8m/s <sup>2</sup>	
Communication Method	LAN Communication	
	Physical Layer	Ethernet (IEEE802.3 Conformity) 10BASE-T / 100BASE-TX (Auto-negotiation / Full / Half Duplex)
	Connector Type	Model RJ-45; 8 poles
	Data Link Layer	CSMA / CD Method
	Network Layer	IP / ARP / ICMP
	Transport Layer	TCP / UDP
	Application Layer	HTTP / NTP / Socket (PHN / PNS), SMTP / SNMP (v1, v2c) / DHCP / DNS / POP3 / RSH
Digital Output (Contact A)	Number of Contacts	8 Contacts
	Contact capacity	Ports 1-7: 30VDC, 3A Inrush Current: 5A or less Minimum Current: 1mA Minimum Voltage: 5VDC (Reference Values) Port 8: 30VDC, 3A Inrush Current: 78A or less (TV-5 Rating) Minimum Current: 10mA Minimum Voltage: 5VDC (Reference Values)
	Wire Gauges	Solid Wire: $\phi$ 0.4-1.2mm (AWG26-16) Twisted Wire: 0.2-1.25mm <sup>2</sup> (AWG24-16)
	Wiring Method	Screwless Terminal Buss
	Input Contacts	Non-voltage Contact NPN Transistor
Digital Input (Contact A)	Number of Contacts	8 Contacts
	Contact capacity	Output ON Current: 6mA or less / Port OFF Bias Voltage: 24VDC
	Wire Diameter	Solid Wire: $\phi$ 0.4-1.2mm (AWG26-16) Twisted Wire: 0.2-1.25mm <sup>2</sup> (AWG24-16)
	Wiring Method	Screwless Terminal Buss
	USB (Host)	USB2.0/1.1 TYPE-A, 1 Port used for log data storage, firmware updates, configuration data uploads and downloads
Power Output	Screw terminals rated at DC24V $\pm$ 10%, maximum current of 200mA	
D_SUB_9pin	Extended Functionality	
Display Part	Total of 18 Green LED Indicators (Power: 1, Status:1, DO: 8, DI: 8)	
Switch Inputs	"Select" Switch, "Reset" Switch, "Clear" Button, "Mode" Switch	
Conformities	EMC Directive (EN55032 (Class A), EN55035), RoHS Directive (EN IEC 63000), FCC Part 15 Subpart B Class A, UL/CSA 60950-1	
Mounting Location	Indoors	
Installation Method	Stationary/EIA Rack Attachment (Optional Part)	
Mounting Direction	Upright Only	
Mass	Main Unit: 1150g	
Protection Rating	IP20 (Self-declaration, based on IEC60529)	
Accessories	Rubber Feet (4 pcs.)	
Optional Parts	Server Rack Mounting Bracket	

### Attention

- If the HUB is not set for auto-negotiation, it may be impossible to communicate.
- Use Port 8 as the output terminal when connecting to a product with a large inrush current, such as a revolving light, etc.

## 1.6 Functionality Description

The following explains the functions for this product.

### 1.6.1 Monitoring Function

This product can monitor the function of a network device or device connected to the contact output.

#### PING MONITOR

##### The network device existence monitor

For this product, a maximum of 24 nodes can be monitored. When an abnormal response in the network of this product is not obtained, it judges an abnormal state and warns the administrator promptly with light and sound.

#### SNMP v1v2c

##### Monitor networking equipment at a low cost.

This product can warn an administrator of generated abnormalities and hindrances promptly with an SNMP command to respond with light and sound to an SNMP TRAP from the equipment (UPS, a printer, a router, a switch, etc.) via the network.

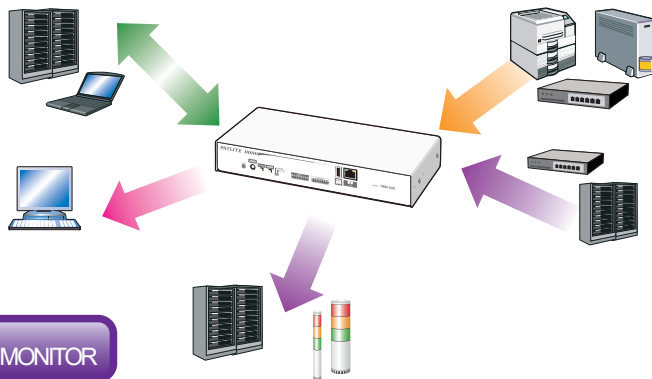

- It can distinguish the variable-bindings.
- Registration of 16 groups (4 nodes per group) is possible.

#### APPLICATION MONITOR

##### Monitoring Application Status

By the user creating an additional commands, the monitoring of a program application' operating condition can be done. (Maximum of 4 nodes)

#### DIGITAL OUTPUT

This product has eight independently controllable output terminals and contact inputs.

#### DIGITAL INPUT

##### Contact Output Equipment Monitoring

This product has 8 digital inputs to monitor signal inputs from equipment, and has a contact output. The operation of this product needs to be set up beforehand to correspond to changes of the input state from the equipment.

### 1.6.2 Communication Commands

#### RSH

##### Controllable with General RSH protocol

The digital output is easily controllable by RSH commands, which is a flexible protocol. Various network integrated management software and event information, including various monitor tools etc., can be turned into a trigger to work in synchronicity with the digital output.

#### HTTP COMMAND

##### Controllable with HTTP command

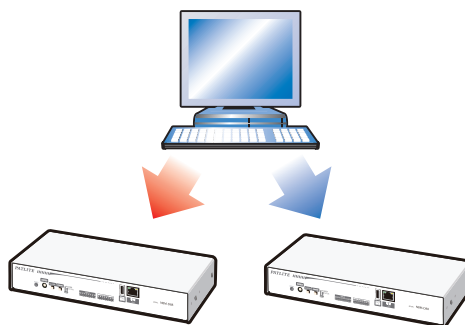

#### SOCKET TRANSMISSION

##### PHN Command Compatibility

The digital output can be controlled with 2 byte commands.

\* Compatible with NHE-NHC-NHM Series  
NHS-NHP-NHL Series  
and PHN-3FBE1 Series.

\* Some functions are limited.

Event Occurance: Command Execution (Digital output ports 1, 3, 5, and 7 are operated)  
PHN Example Command: 57H, 55H

Event Occurance: Command Execution (with digital output port 1 ON, port 3 OFF, other ports with no change.)  
For RSH: rsh 192.168.10.10 -l root alert 19099999

##### PNS Command Compatibility

The PNS Commands can control the digital outputs. All patterns are controllable.

Event Occurance: Command Execution (with digital output port 1 ON, port 3 OFF and other ports with no change.)  
For PNS Command: 58H,43H,53H,00H,00H,08H,01H,09H,00H,09H,09H,09H,09H

### 1.6.3 Communication Function Setup

Commands for RSH or socket can be transmitted when an event occurs, and e-mails or traps can also be sent.

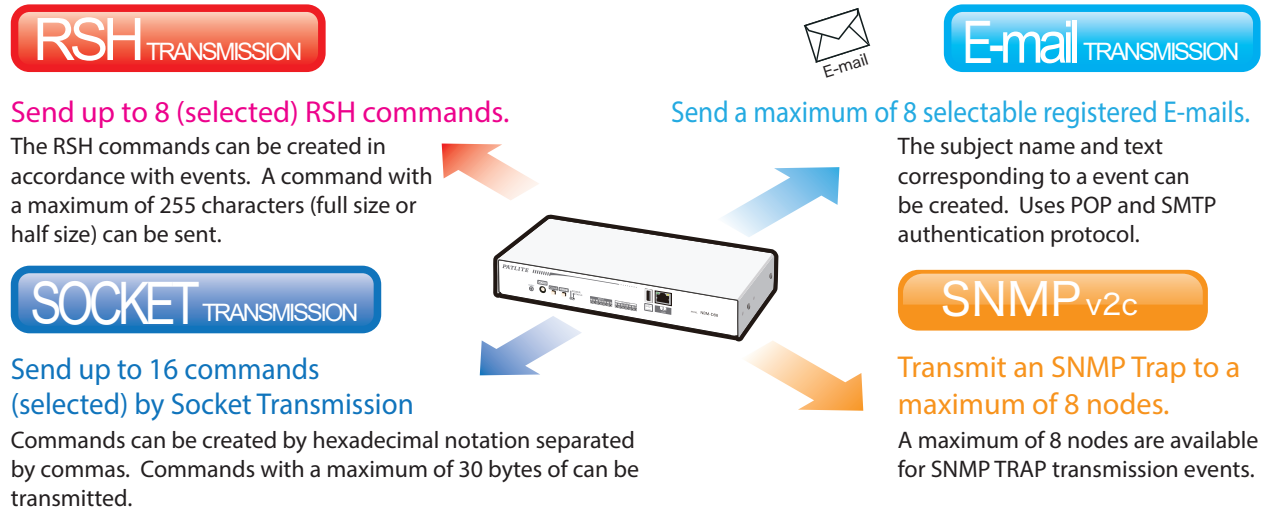

1

### 1.6.4 Setup and Updates

With the web setup tool containing the IP address and detailed setup for the Main Unit, the digital output and "Clear" operation, as well as firmware upgrades and reading/writing configuration data can be done remotely. In addition, changes to the network setup can be done from the PNS Manager. Refer to the "PNS Manager" operation manual for the directions on the PNS Manager.

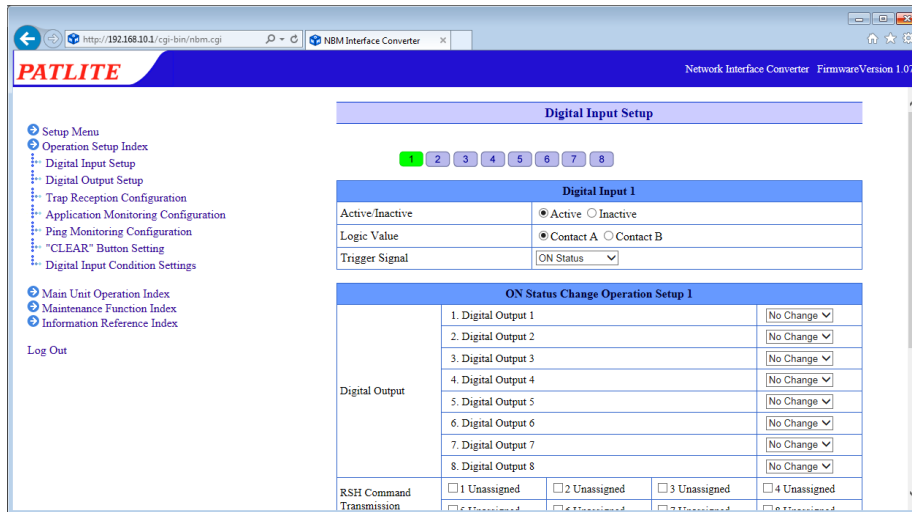

Fig. 1.6.4-1 Web Setup Tool Screen

# 2. Installation Procedure and Flowchart

## 2.1 Installation Procedure and Flowchart

This product offers two methods for configuring the network, "Manual Setup" and "Automatic Network Setup" with the DHCP function.

2

Product Main Unit Installation

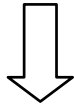

Terminal Bus Wiring

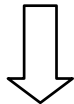

LAN Connection

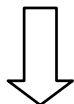

Power Supply Input

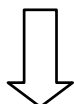

Network Setup

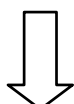

Operation Settings

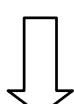

Start-up

Install this product on a level surface. When an installation location is decided, use the rubber feet accessories, or a server rack mounting angle (Optional Parts) if needed.

**Attention** When installing in a high location be sure to secure it so it will not fall.

Wire the Terminal Bus output and input.

Connect the LAN cable to this product.

Connect the AC adaptor to this product. Connect the AC adaptor to this product.

- Manually Setting up Network :  
Set up the network environment configuration. For details, refer to "2.6 Network Setup" on pg. 20.
  - Setting up a network with the DHCP Function :  
Enable the DHCP function and set up the environment. For details, refer to "2.7 Network Setup with the DHCP Function" on pg. 24.
- Once set up, the DHCP function will start as soon as it is active.



Setup the parameters in combination with the environmental conditions to satisfy the purpose for use of this product.

**Attention** After completing the desired setup configuration, reboot this product by pressing the "Reset" switch, or removing the power for a few seconds and reapplying it for the changes to take effect.

This product is now ready to be used.

**Attention** Once the DHCP function is working, it will automatically start up the next time the product is turned on, or rebooted.

## 2.2 Product Installation

 CAUTION	
 Prohibited	<ul style="list-style-type: none"><li>• This product is for indoor use only. Do not use it outdoors.</li><li>• When installing this product, please avoid installation in the following places:<ul style="list-style-type: none"><li>• Where its exposed to direct sunlight</li><li>• Where high temperatures, such as near fire, or in a humid place</li><li>• Where drastic temperature and humidity changes are present</li><li>• Where its exposed to an environment with poor ventilation</li><li>• Where its exposed to vibrations exceeding the specifications</li><li>• Where its exposed to corrosive gas</li><li>• Where its exposed to a salty air environment</li><li>• Where its exposed to dust, iron powder, etc.</li><li>• Where its exposed to high concentrations of chemicals or oil mist</li><li>• Where its exposed to rain, or other types of wet environments</li></ul></li></ul>

- This product is to be installed on a level surface.
- Use the rubber feet accessory for this product when needed.
- When attaching an EIA rack, be sure to set up the optional "Angle type server rack attachment", first.

### 2.2.1 Placing in an unfixed location

When necessary, adhere the rubber feet (four pieces) included to the bottom of this product.

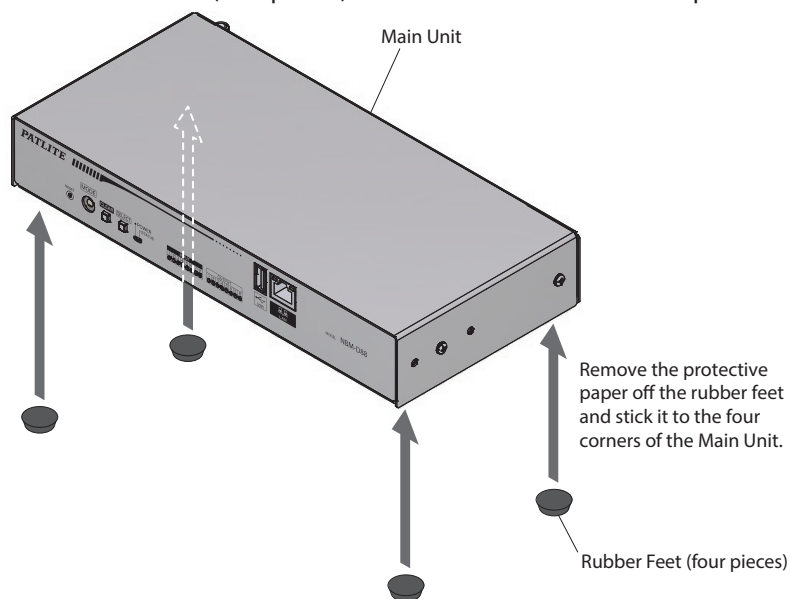

## 2.2.2 When using the Server Rack Mounting Bracket (Optional)

Use the screws included with angle-type server rack when attaching, and as shown in the following figure.

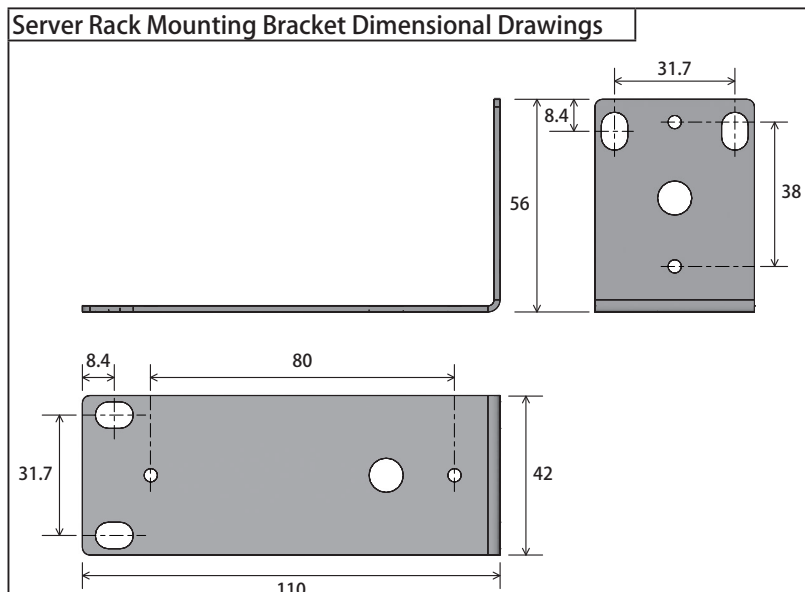
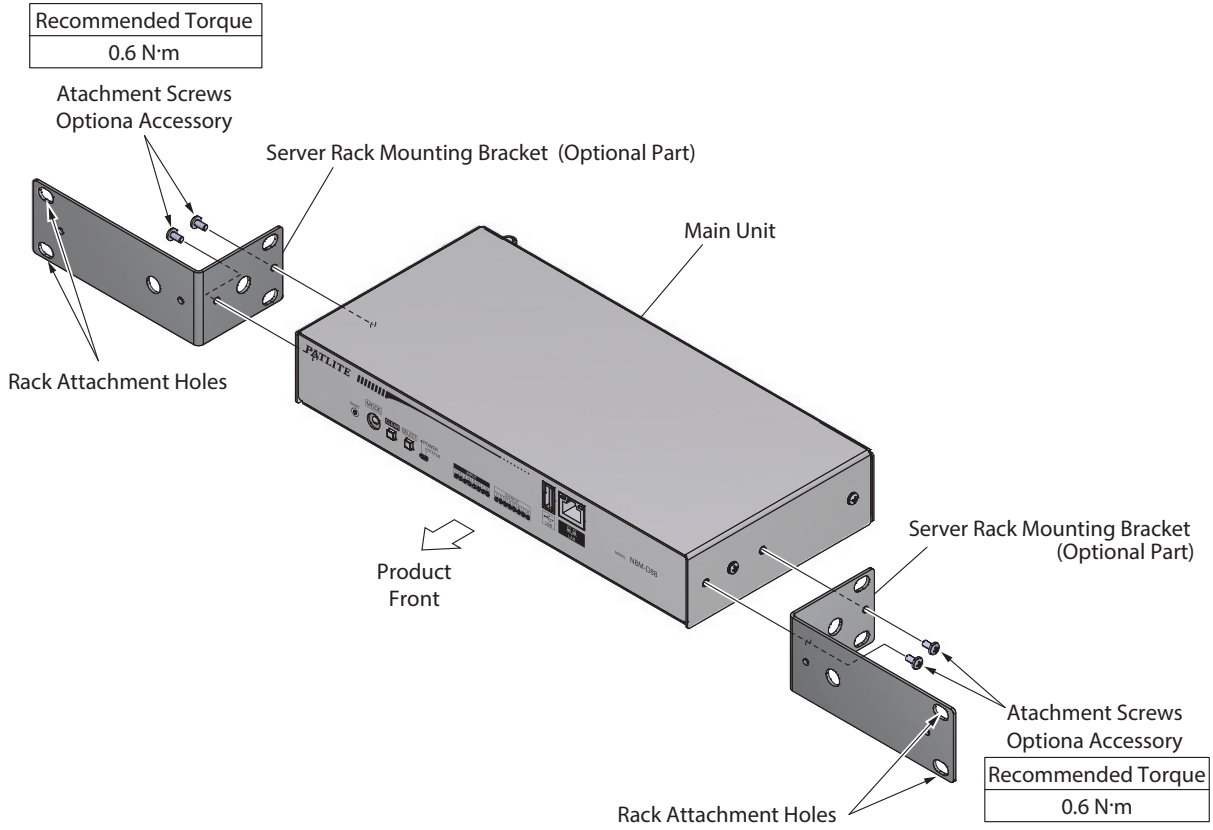

**MEMO**

Read the "Server Rack Mounting Bracket" operation manual for the details of "Server Rack Mounting Bracket" installation.



## 2.3 LAN Connection

<b>CAUTION</b>	
<b>!</b> Enforced	When connecting the LAN cable, be sure to turn off the power first.

Connect the LAN cable to this product.

- The LAN cable should be a category 5 twisted-pair cable (UTP or STP).
- The LAN cable can either be a straight or cross cable.

## 2.4 Terminal Buss Wiring

<b>CAUTION</b>	
<b>!</b> Enforced	<ul style="list-style-type: none"> <li>• Be sure the power is turned off before performing any electric wiring activity. Failure to comply may result in electric shock.</li> <li>• Double check the wiring to prevent mistakes. Failure to comply will result in equipment damage or fire.</li> <li>• Wire the product so that the lead wire does not protrude from the terminal. Failure to comply will result in damage due to short-circuiting.</li> <li>• After wiring, verify that there are no loose wires, or they are easy to pull out.</li> </ul>

### 2.4.1 Input Terminal and Output Terminal Mount Wiring

Wire the input terminal stand and output terminal mount in according to the following steps.

#### [Wiring Method]

- ① Use a minus driver(\*) and push in the tab of the control unit's terminal buss slot.
- ② Insert a signal line lead wire into the slot. (Keep pushing the tab while inserting)
- ③ Release the minus driver to lock the lead wire in place.

\* Use the following type of minus driver.

Name	Tolerable Dimensions
Minus Driver	Blade diameter 1.8-2.1 mm Width 0.7-0.8 mm

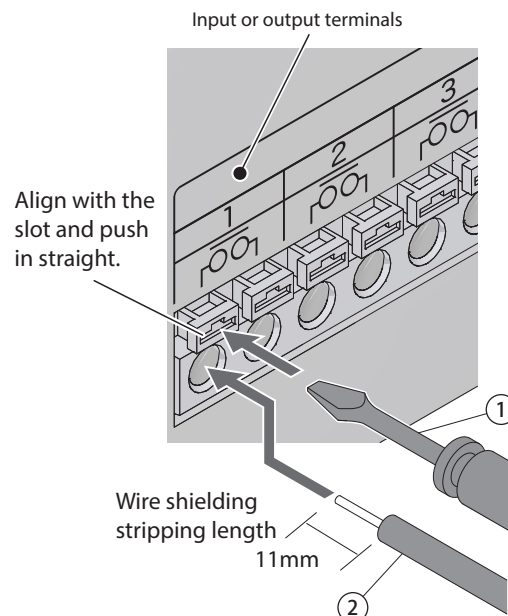

Fig. 2.4.1-1 Input/Output Wires

- The following are the gauge sizes used for the terminal buss.  
Solid Wire:  $\phi 0.4-1.2\text{mm}$  (AWG26-16)  
Twisted Wire:  $0.2-1.25\text{mm}^2$  (AWG24-16)
- Be sure the voltage and current of the equipment connected to the Main Unit output does not exceed its rated values.  
Port 1-7: 30VDC, 3A; Inrush Current 5A or less  
Minimum Current: 1mA; Minimum Voltage: 5VDC (Reference values)  
Port 8: 30V DC, 3A; Inrush current 78A or less (TV-5 rating)  
Minimum Current: 10 mA; Minimum Voltage 5VDC (Reference values)
- Be sure the voltage and current of the equipment connected to the Main Unit input does not exceed its rated values.  
Output ON current at 6mA or less / Port OFF Terminal voltage at 24V
- Be sure to use a minus driver suitable for the driver groove.
- If a screwdriver with an improper dimension is used, or any screwdriver other than a minus screwdriver, the driver groove on the lever part of the terminal may be damaged, causing operation to become impossible.
- The flat blade should be applied vertically to the driver groove. If it is at a slant, there is a possibility that the lever part will be damaged.
- Do not apply excessive strength to the lever section. It may result in cause of failure due to damage or deformation.
- Removal of wiring is done in the reverse order of the wiring method.

## MEMO

## 2.4.2 Power Output Terminal Wiring

Wire the power output terminal according to the following steps.

### [Wiring Method]

- ① Remove the Terminal Buss cover.
- ② Loosen the screw with a phillips screwdriver.
- ③ Insert the lead wire etc. into the Terminal Buss to wire it.
- ④ Tighten the screw and attach the Terminal Buss cover.

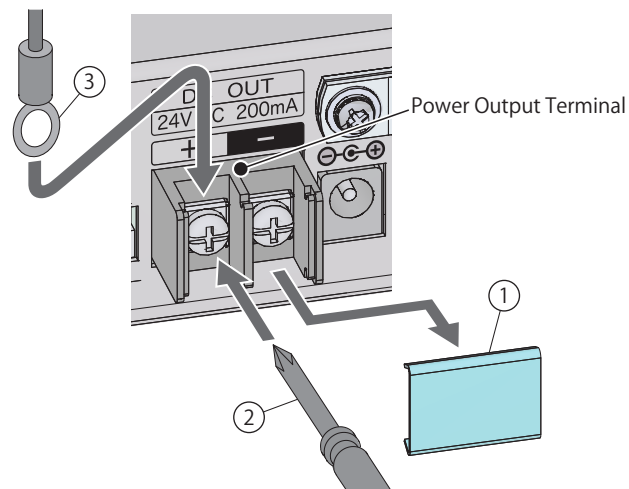

Fig. 2.4.2-1 Power Output Terminal

## Attention

- Be sure to attach the terminal Buss cover. Failure to comply will result in damage due to short-circuiting.
- Do not apply voltage to the output power source terminal buss. Failure to comply will result in equipment damage or fire.
- Be sure the voltage and current of the equipment connected to the power supply output terminal does not exceed its rated values.
  - Power Supply Output Terminal: Output Current Maximum of 200mA
  - Output Voltage Range: DC 21.6-26.4V

## MEMO

- Be sure to properly crimp the round terminals at the lead wire tip.
  - Specifications for suitable round terminals are as follows.
  - Round Terminals: Inner Diameter of  $\phi 3.2\text{mm}$  or more.
  - Outer Diameter of  $\phi 8.0\text{mm}$  or more.
- Removal of wiring is done in the reverse order of the wiring method.

## 2.5 Power Supply Input

Attach the power plug for this product in accordance with the figure below. It takes about 60 seconds from the time the power has been applied until start-up is complete.

### [Connecting Power]

- ① Loosen the screws with a phillips screwdriver and remove the cable clamp.
- ② Pass the AC Adaptor power cable through the cable clamp.
- ③ Fix the cable clamp with a screw.
- ④ Insert the DC plug into the Main Unit. Allow cable slack of about 15 mm from the DC plug.
- ⑤ Insert the AC Adaptor into an electric socket.
- ⑥ When power is switched on, the power LED will light up.

It takes about 60 seconds to complete, from power on to startup. During that time, each LED on the front of the product turns on and flashes as follows.

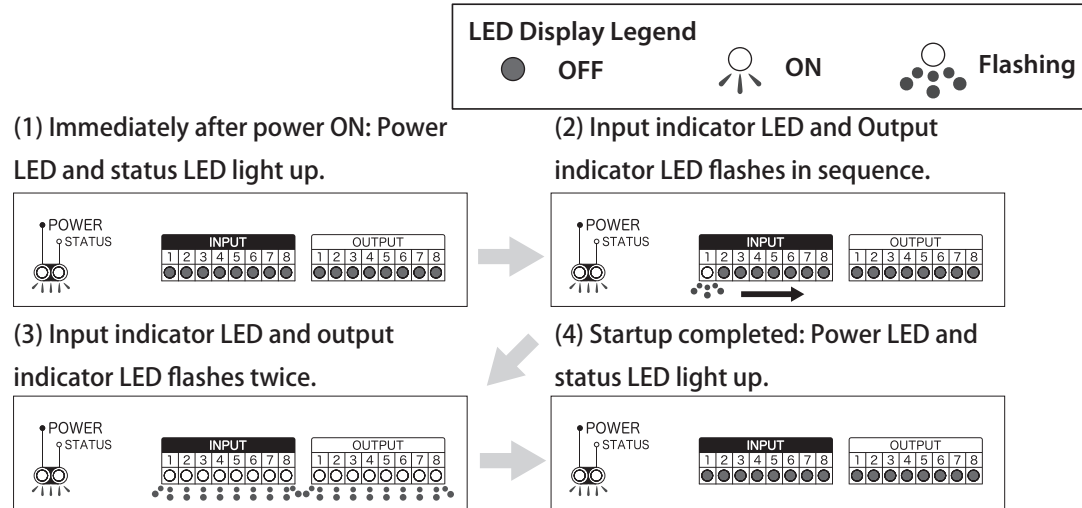

Figure 2.5.0.1 LED display at startup

(4) If startup is not completed, refer to "8 Troubleshooting" on pg. 103.

Fig. 2.5.0-1 LED display at startup

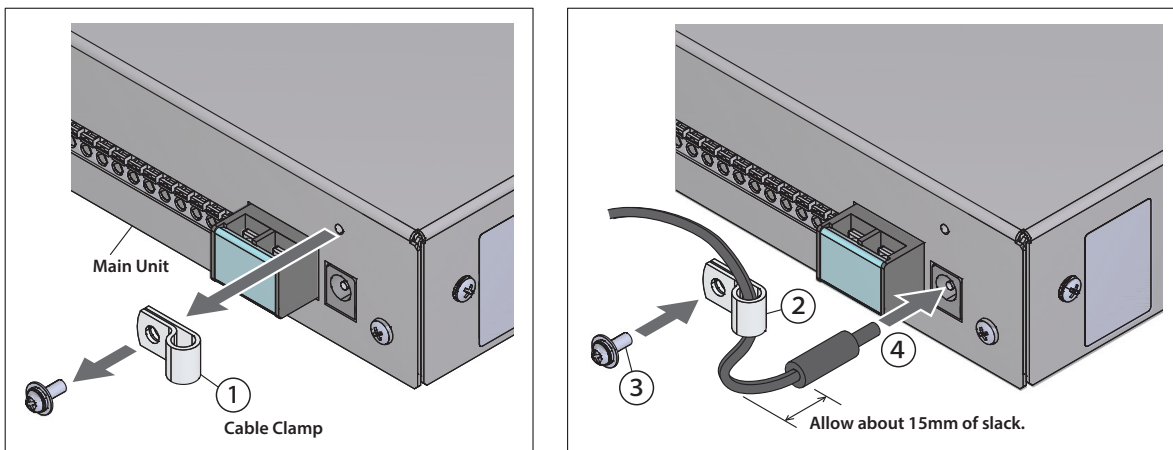

Fig. 2.5.0-2 Power Supply Switching Method



- Do not disconnect and re-insert the DC plug while the AC Adaptor is plugged in. Possible electric shock and damage may occur.
- Check whether dust has built-up on the electric socket or receptacle plug. If dust has built-up, insert the plug after cleaning. Ensure maintenance to avoid dust build-up, because dust accumulation may result in fire.
- Do not touch the electric socket with wet hands. Failure to comply may result in electric shock.

## 2.6 Network Setup

The default IP address for this product is "192.168.10.1".

The IP address change should be done by logging in to the web browser of the personal computer (henceforth, PC) to change the setup. Refer to "2.6.1 Login" on pg. 20 for the login method.

**MEMO**

Recommended browsers are Internet Explorer 10 or higher, or Firefox 12 or higher.

2

### 2.6.1 Login

Various setups for this product is done by logging in from a web browser. In order to log in, the IP address for this product is entered into the address portion of the web browser. (Refer to Fig. 2.6.1-1)

<<Web browser address entry >> <http://192.168.10.1/index.htm>

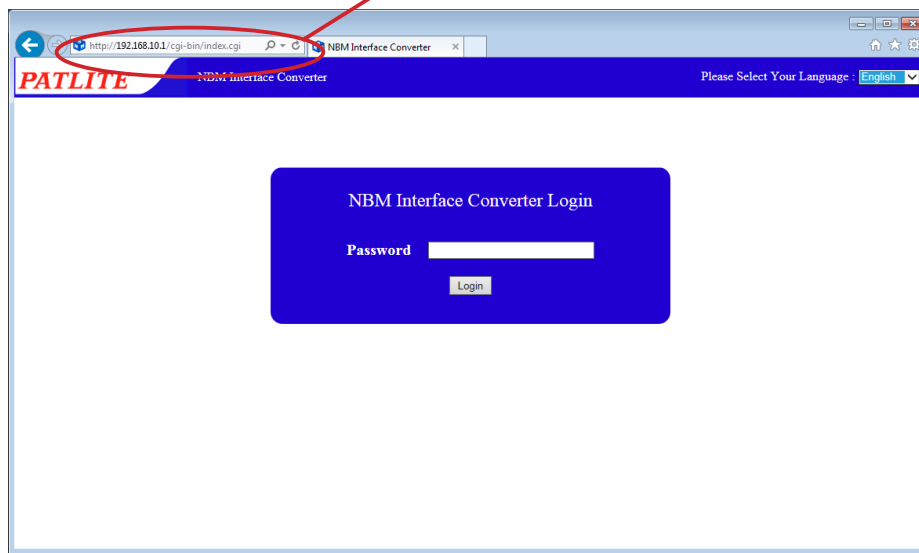

Fig. 2.6.1-1 Login screen

**Attention**

- When the login screen is displayed, enter "patlite" in the password field, then click the "Logging In" button. The default password is set to "patlite". Please be sure to change the password to prevent any security breaching.
- If there is no activity for 10 minutes or more during login, it logs out automatically. Please log in again.
- If the login displays garbled characters, set the browser for Unicode (UTF-8) alphabetic code for it to display normally.
- This product does not support Double log-ins. This prevents being able to access from two or more places.

**MEMO**

Refer to "8 Troubleshooting" on pg. 103 if the login screen is not displayed.

Select the preferred language from the pull down menu in the upper right side of the login screen. (Refer to Fig. 2.6.1-2) There are three kind of languages available, “Japanese”, “Traditional Chinese”, and “English.”

Once selected, the language will be displayed on each screen in the Web setup tool. (Refer to Fig. 2.6.1-2, 1-4)

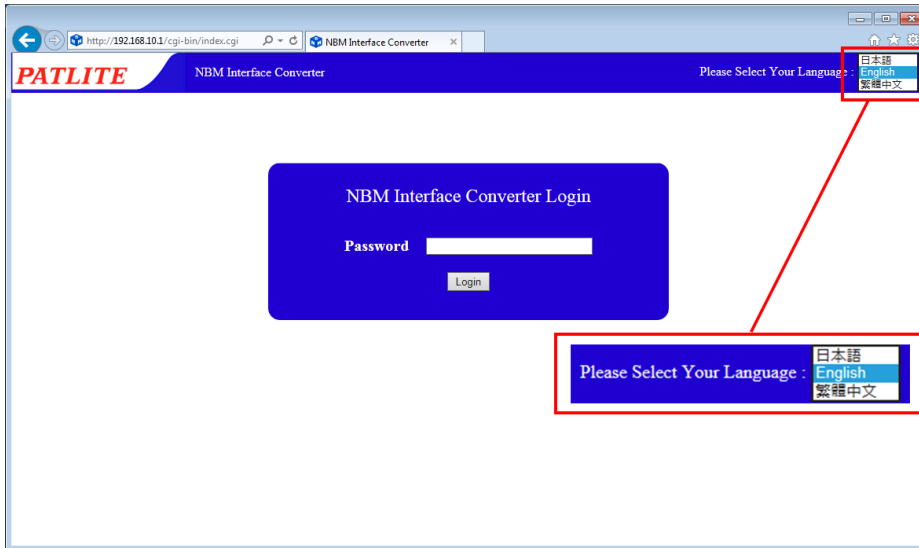

Fig. 2.6.1-2 Login Screen (when selecting “English”)



Fig. 2.6.1-3 Login Screen (when selecting “Japanese”)



Fig. 2.6.1-4 Login Screen (when selecting “Traditional Chinese”)

## 2.6.2 Setting the IP Address

After logging in, the web setup tool will be executed and the “System Setup” screen will be displayed. (Refer to Fig. 2.6.2-1)

- ① Click “Setup Menu” in the Setup Table Entry on the left-hand side of the setting screen.
- ② Click “System Configuration” from the tree menu.

The System Setup Screen is displayed. (Refer to Fig. 2.6.2-2)

The screenshot shows the PATLITE web setup tool interface. The browser address bar displays `http://192.168.10.1/cgi-bin/nbm.cgi`. The page title is "PATLITE Network Interface Converter FirmwareVersion 1.08". On the left, a tree menu is visible with "System Configuration" selected. The main content area is titled "System Configuration" and contains several form fields: "System Name" (NBM-D88), "System Location", "Contact Address" (nbm@patlite.jp), "Log Host Address", "IP Address Configuration Method" (radio buttons for "Setup Manually" and "Setup Automatically", with "Setup Manually" selected), "IP Address" (192.168.10.1), "Net Mask" (255.255.255.0), "Default Gateway" (0.0.0.0), "DNS Server Address" (0.0.0.0), "Host Name" (nbm.patlite.jp), "Domain Name", and "HTTP Command Control Function" (radio buttons for "Active" and "Inactive", with "Inactive" selected). A "Set" button is located at the bottom right of the form.

Fig. 2.6.2-1 Web setup tool screen

In the System Setup Screen, the network can be changed.

### [Setup Method]

- ③ Enter the IP address for the Main Unit.
- ④ Set up a net mask, default gateway, etc. for the customer if needed.
- ⑤ Click the “Set” button to apply the setting.

This screenshot is identical to Fig. 2.6.2-1 but includes red annotations. A red arrow labeled "③" points to the "IP Address" field. A red bracket labeled "④" encompasses the "Net Mask", "Default Gateway", and "DNS Server Address" fields. A red arrow labeled "⑤" points to the "Set" button at the bottom right.

Fig. 2.6.2-2 System Setup Screens

- ⑥ Click the "Network Reboot" button to activate the settings. (Refer to Fig. 2.6.2-3)
- ⑦ Rebooting the network takes about 20 seconds. If there is a delay, click "To the Login screen". (Refer to Fig. 2.6.2-3)

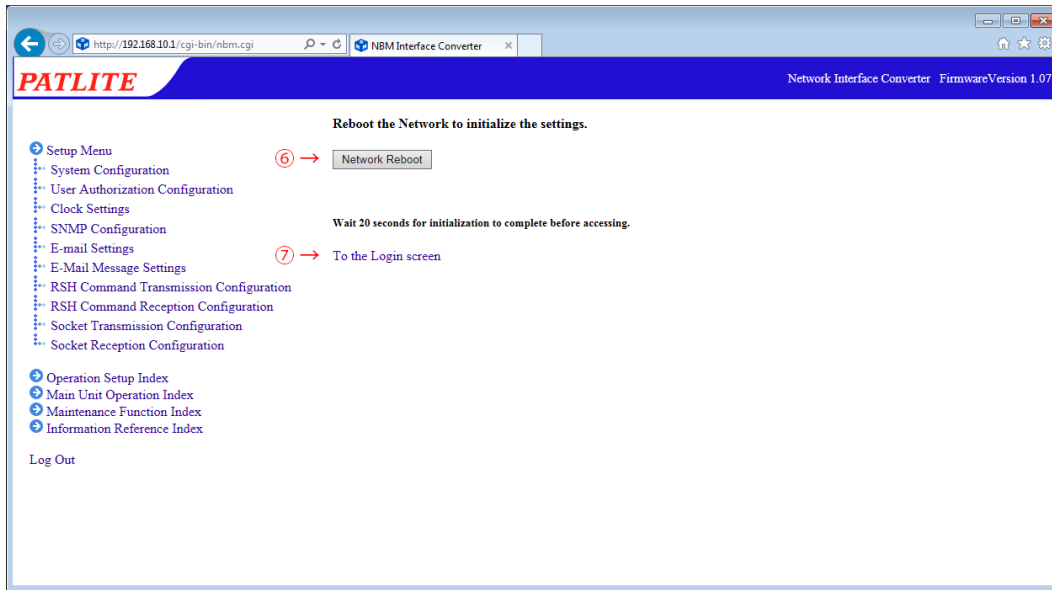

Fig. 2.6.2-3 Network setup reboot screen

### 2.6.3 Setup Confirmation

After clicking "To the Login screen", the web browser address will show the value of the IP address which was changed into, and if the login screen is displayed, the IP address setup is completed. Verify that it can log in. Moreover, when checking the setup values from other networks, check whether the values are shown in the "System Screen".

Check to verify the IP address has changed (an example is it changed into "192.168.10.2").

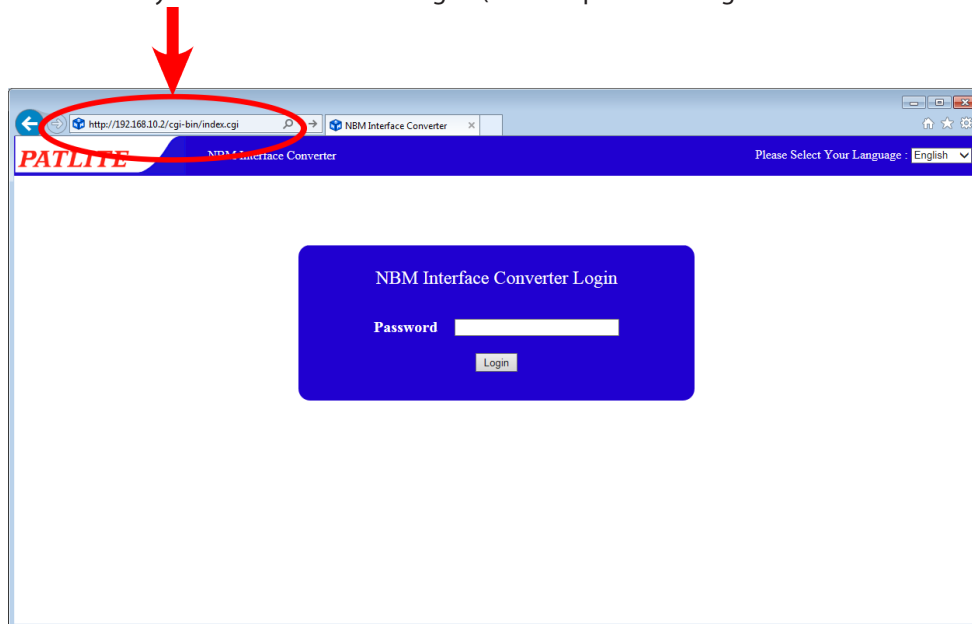

Fig. 2.6.3-1 Setup confirmation

**MEMO**

- Depending on the PC network environment, it may be necessary to change the IP address.
- Even if after logging in and the "System Screen" does not display, refer to "8 Troubleshooting" on pg. 103.

## 2.7 Network Setup with the DHCP Function

This product can access a DHCP Server to acquire network information. Use the following processes to enable the DHCP function in the Web setup tool. Explanation from the setup items.

### [Setup Method]

- ① Select "Setup Automatically" for the IP address Configuration method. (Refer to Fig. 2.7.0-1)
- ② Setup the device and host name, etc. as needed.
- ③ After changing, be sure to click the "Set" button to apply the setting.

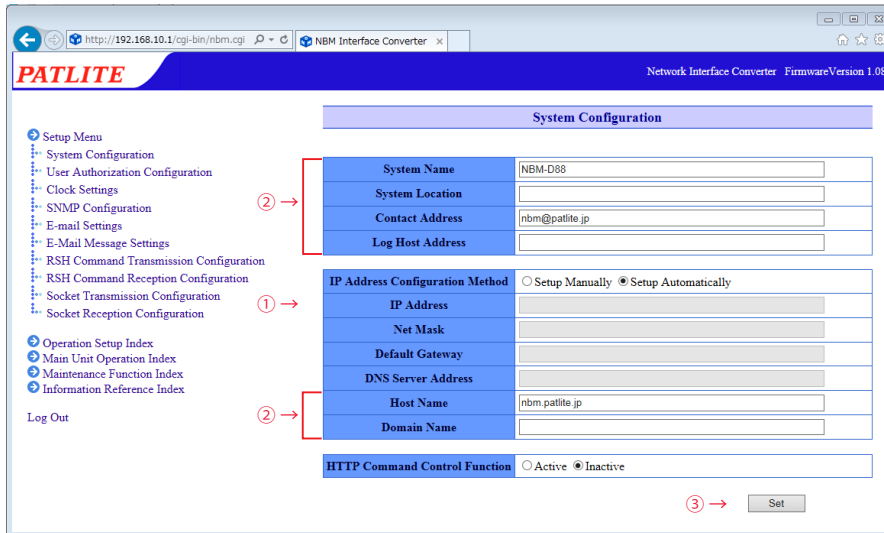

Fig. 2.7.0-1 System Setup Screen (when DHCP function is selected)

- ④ After clicking the "Set" button, click the "Network Reboot" button to reflect the setting. (Refer to Fig. 2.7.0-2)  
Rebooting the network takes about 20 seconds.

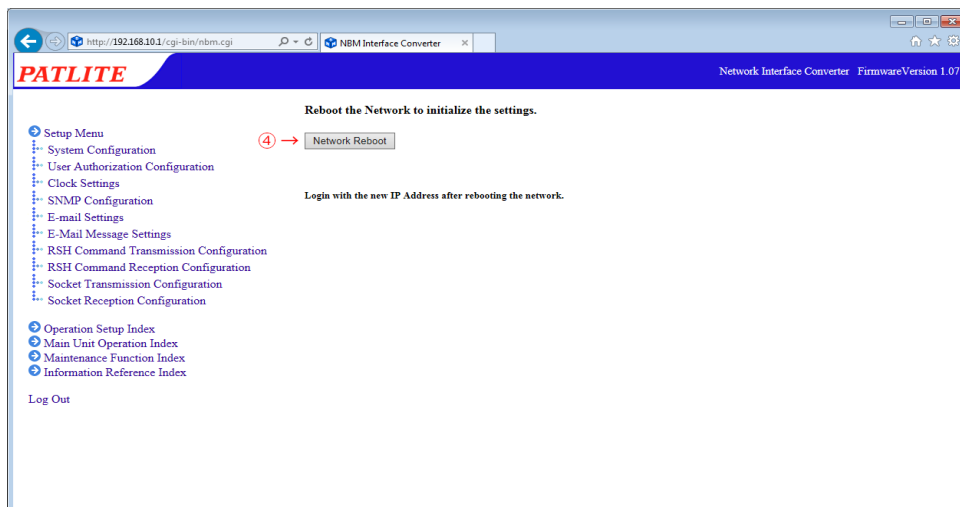

Fig. 2.7.0-2 Network setup reboot screen

### Attention

- If this product is unable to access a DHCP Server, it will return to the factory default network information. When the DHCP function is set for "Setup Automatically", future connections are started after they have become activated.
- When it is necessary to use the manual settings, please use the Web Setup Tool or the PNS Manager. Refer to the "PNS Manager" operation manual for the directions on the PNS Manager.



## 2.8 Clock Settings

The clock for this product can be set up. For setting the clock on this product, the following are two methods.

- PC clock time is reflected when logging in.
- Communicates with an NTP server to adjust the time for this product.

Refer to “4.3 Clock Settings Screen” on pg. 63 for details on setting the time.

### Attention

- This product uses a capacitor as a battery backup for the time stamp.
- Depending on the charge status of the capacitor, it may last up to a half-day, and if the power supply is not applied during the day, a gap in time or the need to reset the clock may be necessary.
- If an application environment requires a time entry, be sure to set up the time before the application.
- If the backup is depleted and the time entry resets, the set time will be labeled as “Jan 1, 2010”.

2

# 3. Functionality Details

Explains the functions of this product.



## 3.1 Digital Input/Output Function

This product can monitor or control the status of eight digital input ports and eight digital output port. This function can set up various operations automatically, when changed to the status of each designated input/output port. The following explains the input/output function.

### 3.1.1 Digital Contact

The Digital Contact indicates the status condition of the contact for the digital input or output. When the "A" contact ("Contact A") is closed, it is recognized to be "ON". When the "B" contact ("Contact B") is open, it is recognized to be "ON". For example, a button switch may use "Contact A" as a point of contact (if the switch is pushed, the point of contact will close and is set to "ON"), and a motion sensor (if motion is detected and the electricity goes out, the point of contact has closed, electricity turns on and it is recognized as "ON") becomes a "B Contact". It may be called "Contact A" and "Contact B".

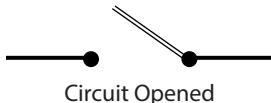
Table 3.1.1-1 Digital input/output Contact Status

Operating Status		ON	OFF	Description
Digital Logic Value		1 01H	0 00H	
Contact Status	Contact A (Make Contact) (Normally Open)	 Circuit Closed	 Circuit Opened	The closed contact turns on, allowing electricity to flow and is to be "ON". The open contact turns off, stopping electricity flow, and is to be OFF.
	Contact B (Break Contact) (Normally Closed)	 Circuit Opened	 Circuit Closed	The closed contact turns on, allowing electricity to flow, but is to be "OFF". The open contact turns on, stopping electricity flow, but is to be "ON".

#### Digital Input Wiring Example

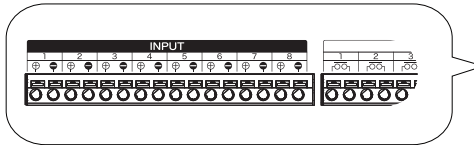

#### Input Terminal Wiring Example

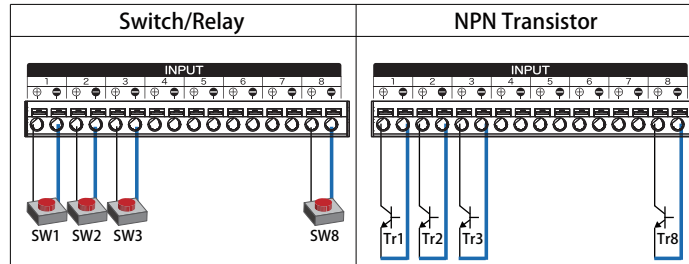

※ PNP Transistor can not be used.

Fig. 3.1.1-1 Digital Input Wiring Example

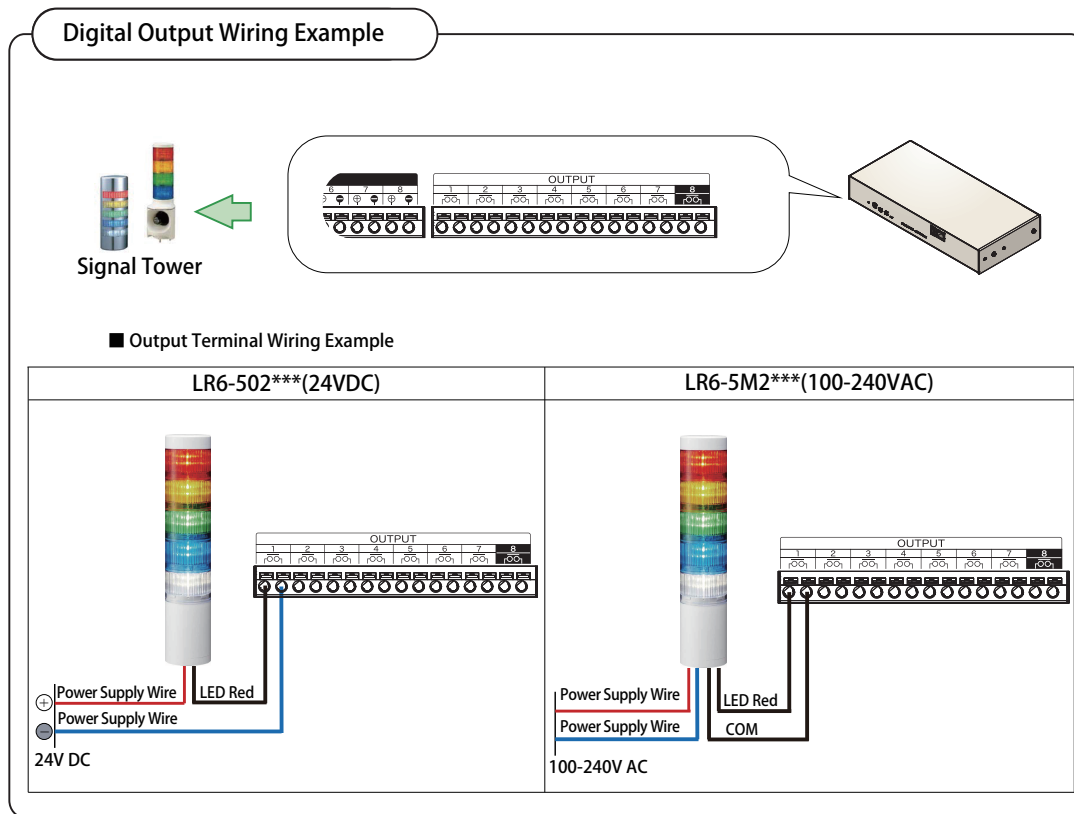

Fig. 3.1.1-2 Digital Output Wiring Example

### 3.1.2 Digital Input Monitoring Function

With the digital input monitoring function, the digital signal entered into one of the eight port input terminals is monitored at regular intervals as a digital input. The digital input can be specified as to which port is to be used in the digital logic setup, which type of contact (“Contact A” or “Contact B”), or a signal definition. In cases where the digital input status change is detected, various controls can be done according to the setup for each port.

In this product, an input trigger can have each digital input port as a signal definition based on conditions set up. The timing for this operation can be created when the digital input status changes.

Below, the “A Contact” digital input signal definition for this product is explained.

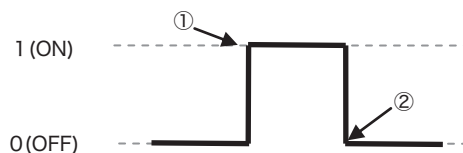

Fig. 3.1.2-1 Definition of a status change

Table 3.1.2-1 Status Change Definitions

<b>ON Status Change</b>	When the digital input turns ON ( ① ), it judges that a status change occurred, and executes an operation according to the setting.
<b>OFF Status Change</b>	When the digital input turns OFF ( ② ), it judges that the status change occurred, and executes an operation according to the setting.
<b>Status Change</b>	When a digital input is ON ( ① ) or OFF ( ② ), it judges that the status change has occurred, and it is controlled according to their individual setup conditions.

The digital input monitor operation setup can be accessed in the “digital input setup” in the “operation setting item” from the Web setup tool. For details, refer to “4.11 Digital Input Setup Screen” on pg. 74.

**MEMO**

- When the input terminal block contact is closed, the “Input display LED” corresponding to each port on the front of the main unit lights up (This light will illuminate, regardless of the digital logic setting when the contact is closed).
- The digital input monitor cycle is 110 ms. In order to determine a stable detection, the input signal has to be maintained for greater than 110 ms of an input signal status change.
- In cases where the digital input status change continues to be constantly changing, the internal management may stop determining a change in status and a delay may happen during operation.
- If the control content has too many stagnate fixed numbers, any new control contents produced is canceled and will not operate.
- Be sure to have sufficient operation confirmation before applying and setting up the operation to trigger the delays and monitoring of the digital input signal.

**3**

**3.1.3 Digital Input Circuit Diagram**

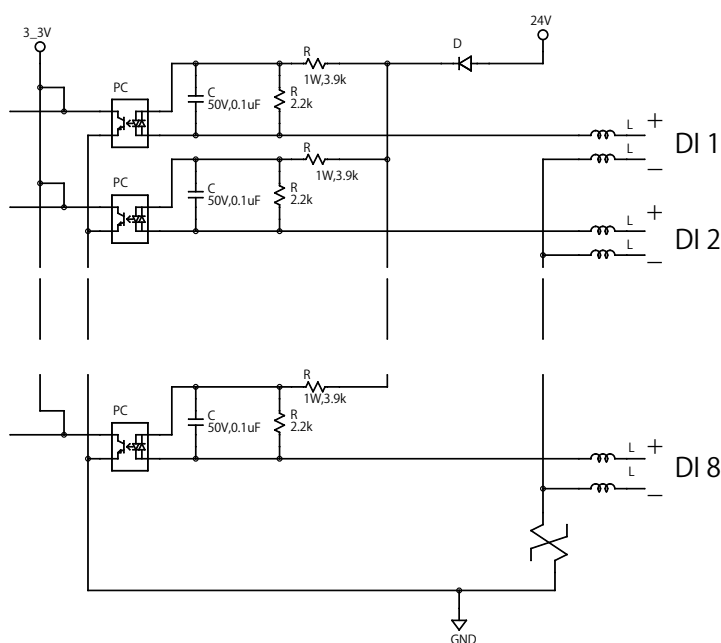

**3.1.4 Digital-Output-Control Function**

With the digital output function, various events are triggered to control the 8-port output terminal block contacts. Each digital output port controlled is prioritized in the order of event occurrence, and independent output control is also possible, respectively. For each digital output port, the digital contact (contact A or contact B), can be set whether or not to be used, as well as an automatic OFF function for the digital output.

**MEMO**

- The digital output status takes effect on the output terminal every 100 ms.
- The “Automatic OFF digital output function” is a function that can be automatically turned OFF from a certain period when time has elapsed after the digital output was turned ON. It can be set from 0 to 600 seconds for each output port.
- When the output Port is set for the RSH alert timer restore Function and the automatic off Function, the RSH alert timer restoration Function takes precedence.

Each digital output port can be operated from the following functions.

- **Web Setup Tool**  
The digital output can be operated from the Web setup tool. For details, refer to “4.20 Digital Output Operation Screen” on pg. 91.
- **SNMP Manager**  
By specifying the digital output port OID from the SNMP manager, the digital output port of the specified OID can be operated. Refer to “5 MIB” on pg. 98 for the operation from an SNMP manager.

- **Digital Input Monitoring Function**  
With the digital input monitoring function, it is possible to operate the digital output according to the status of each input port. Refer to "3.1.2 Digital Input Monitoring Function" on pg. 27 for details.
- **Trap Reception Function**  
When a trap set by the trap reception function is received from the outside, the digital output can be operated. Refer to "3.3 SNMP Function" on pg. 31 for details.
- **PHN Command**  
Each digital output port can be operated by a PHN Command. Refer to "3.7 RSH Command Function" on pg. 36 for details of each command.
- **PNS Command**  
Each digital output port can be operated by a PNS Command. Each digital output port can be operated by a PNS Command.
- **RSH Command**  
Each digital output port can be operated by the RSH command. Refer to "3.7 RSH Command Function" on pg. 36 for details of each command.
- **Ping Monitoring Function**  
With the Ping monitoring function, when the network equipment to be monitored is stopped or restored, the digital output can be operated. Refer to "3.9 Ping Monitoring Function" on pg. 41 for details.
- **Application Monitoring Function**  
With the application monitoring function, the digital output can be operated when the monitored application software is stopped or restored. Refer to "3.10 Application Monitoring Function" on pg. 43 for details.
- **"Clear" Switch Function**  
The digital output can be operated with the "Clear" switch function. For details, refer to "3.11 Status Clear Function" on pg. 44.
- **Digital Input Condition Setup Function**  
The digital output can be operated with a digital input condition setting function. For details, refer to "3.13 Digital Input Condition Setup Function" on pg. 45.

Refer to "4.12 Digital Output Setup Screen" on pg. 76 for setting up a digital output.

**MEMO** • When the contact of the digital output closes, the "Output display LED" corresponding to each port on the front of the main unit lights up (This light will illuminate, regardless of the digital logic setting).

### 3.1.5 Automatic Digital Output OFF Function

The automatic output OFF of the "Automatic Digital Output Function" automatically turns OFF when a certain time (0 to 600 seconds) elapses from the time when the digital output is turned ON. This function operates as follows.

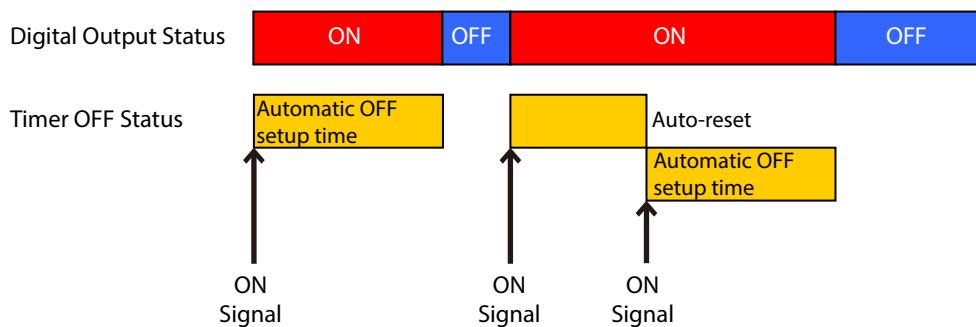

Fig. 3.1.5-1 Automatic Digital Output OFF Function detailed drawing

This function maintains an ON status digital output in seconds, when used with the Web setup tool, after receiving the signal which changes the digital output into a digital logic ON status value. If another ON signal is received during an automatic OFF setup time, the automatic OFF setup time will be re-set, so the digital output signal ON status will be extended.

However, if the automatic OFF setup time is set as 0 seconds, then the automatic OFF function will become invalid.

### 3.1.6 Digital Output Part Graphical Diagram

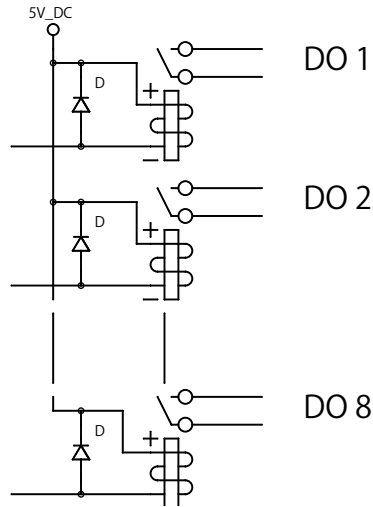

Fig. 3.1.6-1 Digital Output Circuit Schematic

## 3.2 Test Functions

The test function is a function to check the operation by sequentially turning on the digital output. When the test function is executed, it turns on in sequence every second from digital output 1 to digital output 8. During the execution of the test function, it cannot be stopped.

#### [Test Function Startup Method]

- When the "test" or "dotest" commands are sent by the RSH command.
- After completion of the test function, the digital output can be turned off by the following method.
- Press the CLEAR button
  - Use an RSH "clear" or "doclear" command
  - Set the value to "clearAction" from the SNMP function
  - From the digital output operation screen of the Web setup tool
  - Send a clear command with a PNS command
  - Use an HTTP "clear" command

When the test is executed, the digital outputs 1 to 8 are turned "OFF" first.  
(Open contact for Contact A)  
(Close contact for Contact B)

This point indicates the completion of the test function, so it is possible to stop the operation after this.

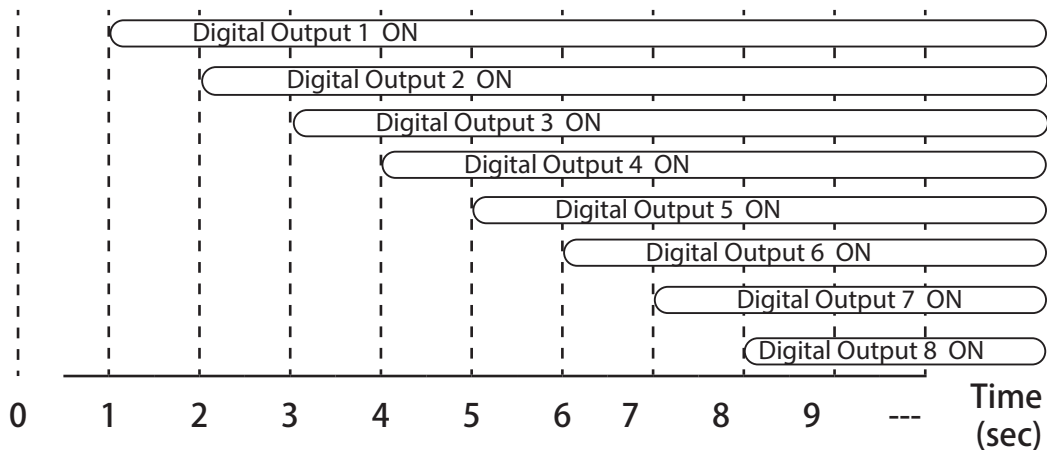

Fig. 3.2.0-1 Detailed Test Operation

**Attention**

- When the test is executed, the output terminal block contacts are actually manipulated according to the "Digital Output Settings" set up. (After seconds pass, the OFF function is included.) Each device connected to the output terminal block will operate accordingly, so be very careful when executing the test (Do not run the test during operation).
- During test execution, the digital output with various commands and monitoring functions can be operated. Be careful when executing a test to confirm operation of this product. Refer to "3.11 Status Clear Function" for details on the method of executing a test operation stop, and stopping.

### 3.3 SNMP Function

This product can control the digital output, obtain the status, send and retrieve TRAPs using the SNMP function.

For customers who purchased this product, Please download the MIB file for use with the SNMP functions. Refer to "4.4 SNMP Configuration Screen" on pg. 66 for more details on the setup method.

**MEMO**

- Refer to "8 Troubleshooting" on pg. 103 for diagnosing issues before requesting customer service.

#### 3.3.1 SNMP SET Digital Output Control Function

The digital output can be controlled by the SNMP SET command. Here is a digital output control as an example for the execution of the state clear function.

**[Application Example 1]** Make the settings as followed for turning ON digital output 1.

Object	Object ID	Value
doEntry1	1.3.6.1.4.1.20440.4.4.1.2.2.1	1

**[Application Example 2]** Make the settings as followed for turning OFF digital output 2.

Object	Object ID	Value
doEntry2	1.3.6.1.4.1.20440.4.4.1.2.2.2	0

**[Application Example 3]** To execute a status "Clear" function, it is set up as followed.

Object	Object ID	Value
clearAction	1.3.6.1.4.1.20440.4.4.1.2.3.1	1

#### 3.3.2 SNMP GET Digital-Input/output Status Acquisition Function

The status of a digital Input/Output can be acquired by the SNMP GET command. The following is an example of a digital input/output status acquisition.

**[Application Example 1]** The digital input 3 is "ON", when the GET command is transmitted.

Object	Object ID	GET Value
diEntry3	1.3.6.1.4.1.20440.4.4.1.2.1.3	1

**[Application Example 2]** The GET command is transmitted when digital output 4 is "OFF".

Object	Object ID	GET Value
doEntry4	1.3.6.1.4.1.20440.4.4.1.2.2.4	0

#### 3.3.3 Trap Reception Function

Receives traps, including the designated sender set up, or the trap containing the set-up OID. When receiving a trap, it can report via digital output, sent RSH command, sent socket, sent mail, and sent trap. For details on the setting method, refer to "4.13 Trap Reception Configuration Screen" on pg. 77.

#### 3.3.4 Trap Transmission Function

When this product is functioning, it sends a trap to the specified destination. For further details on the setting method, refer to "4.4 SNMP Configuration Screen" on pg. 66.

### 3.4 PHN Command Reception Function

With this product, the digital output can be controlled by using the control protocol used in the PHN series via socket communication. The Socket Communication protocol can select a select from "TCP" - "UDP", and the port number can select "10000-65535." The following explains the PHN commands used by the socket communication function. refer to "4.10 Socket Reception Configuration Screen" on pg. 73 for the details on the Setup method.

#### <Writing Command>

Data in the following format can transmit and control the digital output.

"W" (57H) 8 bits								Operation Data 8 bits							
0	1	0	1	0	1	1	1	Refer to Operation Data Contents							

Details of operation data

Digital Output							
8	7	6	5	4	3	2	1

#### • Sending the Write Command Transmission Example

When turning on digital output ports 1, 3, 5 and 7:

In the operation data, input "1" for the bit to turn on, and "0" for the bit to turn OFF.

[Command]

"W" (57H) 8 bits								Operation Data (55H)							
0	1	0	1	0	1	1	1	0	1	0	1	0	1	0	1

#### MEMO

- "ON" and "OFF" here represent the digital logic value of each port.
- The contact open/close state differs depending on whether it is an "A contact" or "B contact".

#### [Response from this product]

##### • Normal Response (Output Response)

「A」 (41H)	「C」 (43H)	「K」 (4BH)
1 byte	1 byte	1 byte

##### • Response Error (Output Failed)

「N」 (4EH)	「A」 (41H)	「K」 (4BH)
1 byte	1 byte	1 byte

#### <Reading Command>

The current operating status of this product is requested.

"R" (52H) 8 bits							
0	1	0	1	0	0	1	0

#### [Response from this product]

##### • Normal Response (Output Response)

"R" (52H) 8 bits								Digital Output							
0	1	0	1	0	0	1	0	8	7	6	5	4	3	2	1

##### • Data Acquisition Response Example

When the digital output ports 1 and 2 are ON,

Response Data: 0000 0011 = 03H

"R" (52H) 8 bits								Response Data: (03H) 8 bits							
0	1	0	1	0	0	1	0	0	0	0	0	0	0	1	1

When the digital output ports 4 and 8 are ON,

Response Data: 1000 1000 = 88H

"R" (52H) 8 bits								Response Data: (88H) 8 bits							
0	1	0	1	0	0	1	0	1	0	0	0	1	0	0	0

##### Response Error (Output Failed)

「N」 (4EH)	「A」 (41H)	「K」 (4BH)
1 byte	1 byte	1 byte

#### MEMO

- "ON" and "OFF" here represent the digital logic value of each port.
- The contact open/close state differs depending on whether it is an "A contact" or "B contact".



### 3.5 PNS Command Reception Function

The PNS Command is a special command which controls the digital output of the NBM series. The Socket Communication protocol can be selected from "TCP" or "UDP", and the communication port is from "10000-65535". The following explains the PNS commands being used with a socket communication setup.

#### <Writing Command>

Data in the following format can transmit and control the digital output.

Product Category "XC"		Identifier "S"	(Open)	Data Size			Data Area 8 bytes					
58H	43H	53H	00H	00H	08H	See Below						

#### Product Category

The product is classified in "XC".

#### Identifiers

"S" is used.

#### Data Size

Capacity of data control bits (data to transmit)

#### Data Area

Data Area 8 bytes							
Digital Output							
1	2	3	4	5	6	7	8

#### [Each Port Output]

ON	01H
OFF	00H
No Change	09H

#### MEMO

- "ON" and "OFF" here represent the digital logic value of each port.
- The contact open/close state differs depending on whether it is an "A contact" or "B contact".

#### • Sending the Write Command Transmission Example

When wanting to operate the digital output as "port 1: ON; port 3: OFF; other ports: No Change":

#### [Command]

Product Category "XC"		Identifier "S"	(Open)	Data Size			Data Area						
58H	43H	53H	00H	00H	08H	01H	09H	00H	0s9H	09H	09H	09H	09H

#### [Response from this product]

##### • Normal Response (Output Response)

ACK
06H

##### • Response Error (Output Failed)

NAK
15H

### <Reading Command>

Transmitting the following data will execute the status of the digital output.

Product Category "XC"		Identifier "G"	(Open)	Data Size	
58H	43H	47H	00H	00H	00H

### Read Command Response

Response Data: 16 bytes															
Digital Output								Digital Input							
1	2	3	4	5	6	7	8	1	2	3	4	5	6	7	8

#### • Data Acquisition Response Example

When "digital input ports 1, 2, 5 and 8 are ON; 3, 4, 6 and 7 ports are OFF; digital output ports 3, 5 and 6 are ON; 1, 2, 4 are OFF":

Response Data: 16 bytes															
Digital Output								Digital Input							
1	2	3	4	5	6	7	8	1	2	3	4	5	6	7	8
00H	00H	01H	00H	01H	01H	00H	00H	01H	01H	00H	00H	01H	00H	00H	01H

### <Status Condition "Clear" Command>

All digital outputs are turned OFF and it returns from the monitoring abnormal condition to the monitoring condition. The values (time and number) accumulated in the input condition setting is erased. refer to "3.11 Status Clear Function" on pg. 44 for command run-time operations.

Product Category "XC"		Identifier "C"	(Open)	Data Size	
58H	43H	43H	00H	00H	00H



## 3.6 Mail Transmission Function

Up to eight E-mail subjects can be registered to transmit. Up to 16 possible registrations combining the subject and the body of outgoing mail can be sent. The user authentication method during transmission can be selected from either "SMTP Authentication", "POP Authentication", or "No Authentication". Refer to "3.11 Status Clear Function" on pg. 44 and "4.6 E-Mail Message Settings Screen" on pg. 69 for details on the Setup method.

### 3.6.1 E-mail Message Contents

The subject and the body of outgoing mail can be selected from 16 possible registrations. The e-mail text would include the equipment name, its location, the sender, the message, and supplementary information indicated in Table 3.6.1-1 below. The contents of the registered subject is indicated. E-mail is transmitted with the following contents.

Table 3.6.1-1 E-mail Transmission Contents

System Location	: <The setup location is indicated>
System Name	: <The device name setup is indicated>
Contact Address	: <The contact set up is indicated>
Generated Event	: <The E-mail Sending opportunity event used is indicated>
Supplementary Information	: <Indicates accompanied information for an event>
<The selected text is registered>	

Table 3.6.1-2 E-mail Transmission Timing Event

Classification	Contents
Digital input status change	When the status changes in a digital input, a transmission is sent.
Application monitoring object status change	When an Application monitored object is in an abnormal condition, or is restored from an abnormal condition, a transmission is executed.
Ping monitoring object status change	When a Ping monitored object is in an abnormal condition, or is restored from an abnormal condition, a transmission is executed.
Trap Reception	Sent when a trap is sent from the registered sender address.
Pressing the "Clear" button	It transmits when the clear switch to this product is pushed.
During a digital input condition setup agreement	When conditions agree on the set up by the digital input condition, a transmission is sent.

Table 3.6.1-3 E-mail registered event and accompanied information

Written Event	Written Supplementary Information
Digital input was set to ON.	Port [1-8]
Digital input was set to OFF.	Port [1-8]
Application Monitor Abnormality detected.	Equipment Name : Registration Address : Port No.
Application Monitor Recovery detected.	Equipment Name : Registration Address : Port No.
Ping Monitor Abnormality detected.	Equipment Name : Registration Address
Ping Monitor Recovery detected.	Equipment Name : Registration Address
Trap was received.	Group Name : IP Address
"Clear" Button was pushed.	None
Digital input conditions agree.	Conditions [1-5]

## 3.7 RSH Command Function

RSH (remote shell) is a CUI program which executes a shell command from one computer to another computer via a computer network. Explains how to control a digital output from the RSH command.

### 3.7.1 RSH Command Reception

The command syntax which this product can receive is indicated below. For details on the "RSH Command Connection Authentication /Operation after Reception" setting method, refer to "4.8 RSH Command Reception Configuration Screen" on pg. 71.

Table 3.7.1-1 Receivable Commands

Command	Contents
alert	Digital output control is possible.
clear/doclear	Returns to a normal status.
status	The digital input/output status can be acquired.
test/dotest	Operation test is performed.
read	The digital input status can be acquired.

#### Using the RSH Commands

Command Input Method

rsh IP Address [-l account] Command [Option]

Command Input Method (when the designated sender address is inactive)

**rsh\_IP address\_-l\_designated sender address invalid common account\_\_command\_[Option]**

#### MEMO

- " \_ ": indicates a space. [ ]: Indicates an optional command.  
The account abbreviation condition is limited to where the IP address and account name (half-width alphanumeric character) of the PC transmitting the RSH command is registered on a command reception setup screen.
- Here, "ON" and "OFF" expresses the digital logic value for each port.  
The contact switching conditions vary by the "A-contact" and "b-contact".

#### <<alert Command>>

Contents: Digital output control is possible.

Format: alert\_DO1 - DO8\_ [sec]

Return Value: Status after Command Execution

Option: Refer to Table 3.7.1-2.

Table 3.7.1-2 Option Explanation

Classification	Description
DO1-DO8	About digital outputs 1-8, OFF "0", ON "1", no operation "9" are entered.
sec	Restores the Signal Tower to its previous command status. (Timer restore function) When the set time elapses, the operation returns to the digital output operation before setting the timer restore function. The time can be set from zero to 99. The status will not return if no input or a zero has been entered.

#### • Command Transmission Example

Example 1 Product IP address "192.168.10.10" Account "root"

When operating "Port 1 ON; Port 3 OFF; others not operating."

**rsh\_192.168.10.10\_-l\_root\_alert\_19099999**

Example 2 Product IP Address "192.168.10.10" Designated sender IP address account "patlite"

When operating "Port 1 ON; Port 3 OFF; others not operating."

**rsh\_192.168.10.10\_-l\_patlite\_alert\_19099999**

Example 3 When the product IP address is "192.168.10.10", and "Port 1 ON; port 3 OFF; others not operating" for 20 seconds to operate. (When the account is omitted)

**rsh\_192.168.10.10\_alert\_19099999\_20**

<<clear / doclear Command>>

Contents: All digital outputs are turned OFF and change from the monitoring abnormal condition to the monitoring condition.  
 The values (time and number) accumulated in the input condition setting is erased.  
 Refer to "3.11 Status Clear Function" on pg. 44 for command run-time operations.

Format: clear, doclear

Return Value: Status after Command Execution

• **Command Transmission Example**

Example 1 Transmit the command to the product's IP address "192.168.10.10."  
 When using an invalid designated sender address account "patlite":  
rsh\_192.168.10.10\_-l\_patlite\_clear  
 When an account abbreviation is made.  
rsh\_192.168.10.10\_clear

<<status Command>>

Contents: The current digital output status is returned.

Format: status\_[di]\_[do] or, status\_[do]\_[di]

Return Value: Current Condition

Option: Refer to Table 3.7.1-3

Table 3.7.1-3 Option Explanation

Classification	Description
di	The digital input status is returned.
do	The digital output status is returned.

• **Command Transmission Example**

The IP address of a product: 192.168.10.10

Status of a digital input:

The ports 1, 2, 4, 6, and 7: OFF

The ports 3, 5, and 8: ON

Status of a digital output:

The ports 2, 3, 6, and 8: OFF

The ports 1, 4, 5, and 7: ON

Designated sender account: patlite

Example 1 For the "status". The digital output status is returned.  
rsh\_192.168.10.10\_-l\_patlite\_status  
**Acknowledge: 10011010**

Example 2 In the case of a "di" option. The digital input status is returned.  
rsh\_192.168.10.10\_-l\_patlite\_status\_di  
**Acknowledge: 00101001**

Example 3 In the case of a "do" option. The digital output status is returned.  
rsh\_192.168.10.10\_-l\_patlite\_status\_do  
**Acknowledge: 10011010**

Example 4 In the case of a "do" and "di" option. At the head of a sentence, the "DO:" is attached for the status of a digital output and the "DI:" is attached to it for the status of a digital input to be returned to it. (The status is returned as an option.)  
rsh\_192.168.10.10\_-l\_patlite\_status\_do\_di  
**Acknowledge: DO: 10011010**  
**DI: 00101001**  
rsh\_192.168.10.10\_-l\_patlite\_status\_di\_do  
**Acknowledge: DI: 00101001**  
**DO: 10011010**

### <<test / dotest Command>>

Contents: Execute confirmation of a digital output operation.  
After all digital outputs are turned off, the ON status is set at a 1 second interval from port 1 to port 8.

Format: test, dotest

Return Value: 00000000  
10000000  
11000000  
11100000  
11110000  
11111000  
11111100  
11111110  
11111111

(It is not displayed, in cases where it is performed by PRSH.)

#### • Command Transmission Example

Example 1 When checking the operation of the digital output of the product's IP address "192.168.10.10".  
When using invalid designated sender address account "patlite"

rsh\_192.168.10.10\_-l\_patlite\_test  
rsh\_192.168.10.10\_-l\_patlite\_dotest

Acknowledge: The above "return value"

When checking the operation of the digital output. (When the account is omitted)

rsh\_192.168.10.10\_test  
rsh\_192.168.10.10\_dotest

Acknowledge: The above "return value"

When confirming the operation of the digital output of the IP address "192.168.10.100" of the product.

When the account "root" is used.

rsh\_192.168.10.100\_-l\_root\_test  
rsh\_192.168.10.100\_-l\_root\_dotest

Acknowledge: The above "return value"

When checking the operation of the digital output. (When the account is omitted)

rsh\_192.168.10.100\_test  
rsh\_192.168.10.100\_dotest

Acknowledge: The above "return value"

### <<read>>

Contents: The current digital input status is returned.

Format: read

Return Value: Current Condition

#### • Command Transmission Example

Example 1 When acquiring an input state of a product whose IP address is "192.168.10.10" and whose status is "digital input port 1 and port 3:ON; all others are OFF"

When using the designated sender account "patlite" to obtain the product status.

rsh\_192.168.10.10\_-l\_patlite\_read

Acknowledge: 10100000

### 3.7.2 RSH alert Timer Reset Function

The procedure and operation of the timer restoration function which can set up the operating time of a digital output are explained.

**[Process]**

- ① Transmit the command to the products IP address "192.168.10.10"  
Account executes the command for "root," which operates "digital output 1 is ON" for 10 seconds.  
`rsh_192.168.10.10_-l_root_alert_19999999_10`
- ② 3 seconds after ①, the command was transmitted to the products IP address "192.168.10.10".  
A command is executed to activate the "root" account, and "digital output 5: ON" for 10 seconds.  
`rsh_192.168.10.10_-l_root_alert_99991999_10`

The digital output port that is set to "9" (no operation) by the alert command is not affected by the timer interval of the command executed later.

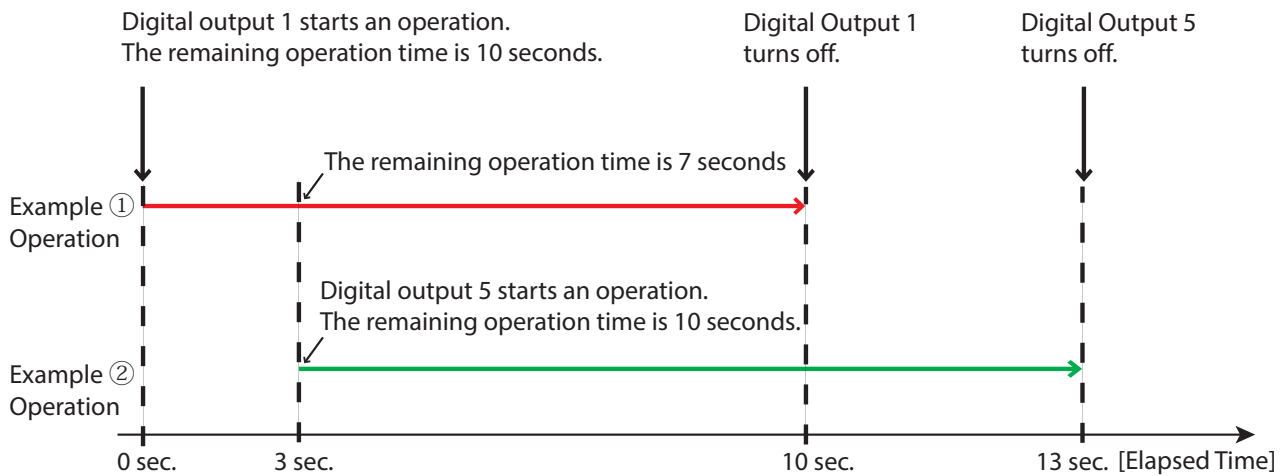

Fig. 3.7.2-1 Timer Restore Function Operation

**Attention** • When the output Port is set for the RSH alert timer restore Function and the automatic off Function, the RSH alert timer restoration Function takes precedence.

### 3.7.3 RSH Command Transmission Function

When various inputs, operations, and preset events occur, the RSH commands are transmitted of up to 8 locations. To set up, register the destination address, account, and send command.

Depending on the destination device, since the operation of each command differs, check the specifications of the destination device.

The RSH command setting is done by the Web setup tool. Refer to "4.7 RSH Command Transmission Configuration Screen" on pg. 70.

Events which can be set up are as follows.

Table 3.7.3-1 RSH Command Transmission Timing

Event	Description
Digital input status change	The RSH command is transmitted when a digital input status change occurs.
application monitoring object status change	An RSH command is sent when the application monitoring target becomes an abnormal state, or when recovering from an abnormal state.
Ping monitoring object status change	An RSH command is sent when the Ping monitoring target becomes an abnormal state, or when recovering from an abnormal state.
Trap Reception	The RSH command is transmitted when a trap is received from the designated sender address registered.
Pressing the "Clear" button	The RSH command is transmitted when the clear switch is pushed.
Digital input condition setting function (When matched)	An RSH command is sent when conditions set in the digital input condition settings agree.

**MEMO** When the product is sending an RSH command transmission back to itself, set the loopback address to (127.0.0.1) as the destination address.

**Attention** When sending the RSH command to itself, keep the event occurrence interval, such as digital input, to at least 500ms.

### 3.8 Socket Transmission Function

When various inputs, operations, and preset events occur, send commands via Socket communication. The setup is made by registering the transmission destination address, the TCP (or UDP) protocol, and port numbers between 5001-65535.

Commands are expressed in hexadecimal notation from the beginning and the comma separates values in one byte units to describe it. Up to 30 bytes per command can be registered, of up to 16 commands.

The Socket Transmission setting can be done in the Web setup tool. Refer to “4.9 Socket Transmission Configuration Screen” on pg. 72.

Events which can be set up are as follows.

Table 3.8.0-1 Socket Transmission opportunity

Event	Description
Digital input status change	A command is transmitted when a digital input status change occurs.
application monitoring object status change	A command is transmitted when the application monitoring object becomes abnormal, or when it restores from it's abnormal condition.
Ping monitoring object status change	A command is transmitted when the Ping monitoring object becomes abnormal, or when it restores from it's abnormal condition.
Trap Reception	A command is sent when a registered trap is received.
Pressing the “Clear” button	A command is sent when the “Clear” switch is pushed.
Digital input condition setting function (When matched)	A command is sent when the conditions set in the digital input condition settings agree.

**[Command Transmission Example]**

- Example 1    When using the PNS command to operate the digital output of another NBM-D88 as “Port 1: ON, Port 3: OFF, other ports: maintain status”  
**58,43,53,00,00,08,01,09,00,09,09,09,09**
- Example 2    When using the PHN command to operate the digital output of another NBM-D88 as “Port 2, 5, 7: ON, Port 1, 3, 4, 6, 8: OFF”  
**57,52**
- Example 3    When using the PNS command to operate the Network Monitoring Signal Tower NHL-3FB1-RYG as “Red:Lighting; Amber: Flashing Pattern 1; Green: Flashing Pattern 2; Buzzer: sounding Pattern 4”  
**58,58,53,00,00,06,01,02,03,00,00,04**
- Example 4    When using the PHN command to operate the Network Monitoring Signal Tower NHL-3FB1-RYG as “Red: Flashing Pattern 1; Amber: off; Green: Lighting; Buzzer: sounding Pattern 1”  
**57,2C**

**MEMO**

When the product is sending a transmission back to itself, set the loopback address to the destination address.





### 3.9 Ping Monitoring Function

The Ping transmission is used to monitor the response of a device in a network. A maximum of 24 nodes can be monitored and the control of abnormality detection and abnormality recovery can be set up separately.

#### 3.9.1 Ping Monitoring Function

The following explains how to set up the Cycle count Error threshold and Pings per test cycle for the Ping Monitoring Function. The Pings per test cycle can set up from 1 to 600 seconds and the number of cycles can be set from 1-3.

The following is an example of setting the Pings per test cycle with a value of "2" and "3".

- If a Cycle count Error threshold is set to "2", in cases where abnormality detection was generated twice, the Ping monitor abnormality function will operate.
- If the Pings per test cycle is set to "3", then the Pings per test cycle will send three "packets" during the Ping test cycle period. (Refer to the following figure)

An abnormality judgement is detected during a Ping test cycle period.

- ① No abnormality is detected when a Ping response is 1 out of 3.
- ② When a Ping monitoring response does not respond to a 3 out of 3, the abnormality judgment is counted as 1 time.
- ③ Even if there is no Ping response during the next interval, the abnormality judgment is counted as 1 time. The total number of transmission times is set to "2", and the Ping Monitoring Abnormality Condition is executed.

**MEMO** When the Abnormality Judgement Value is set as a "1", if the next Ping Monitoring Abnormality Condition is judged as "no abnormality", then the number of judging abnormality is cleared (back to "0").

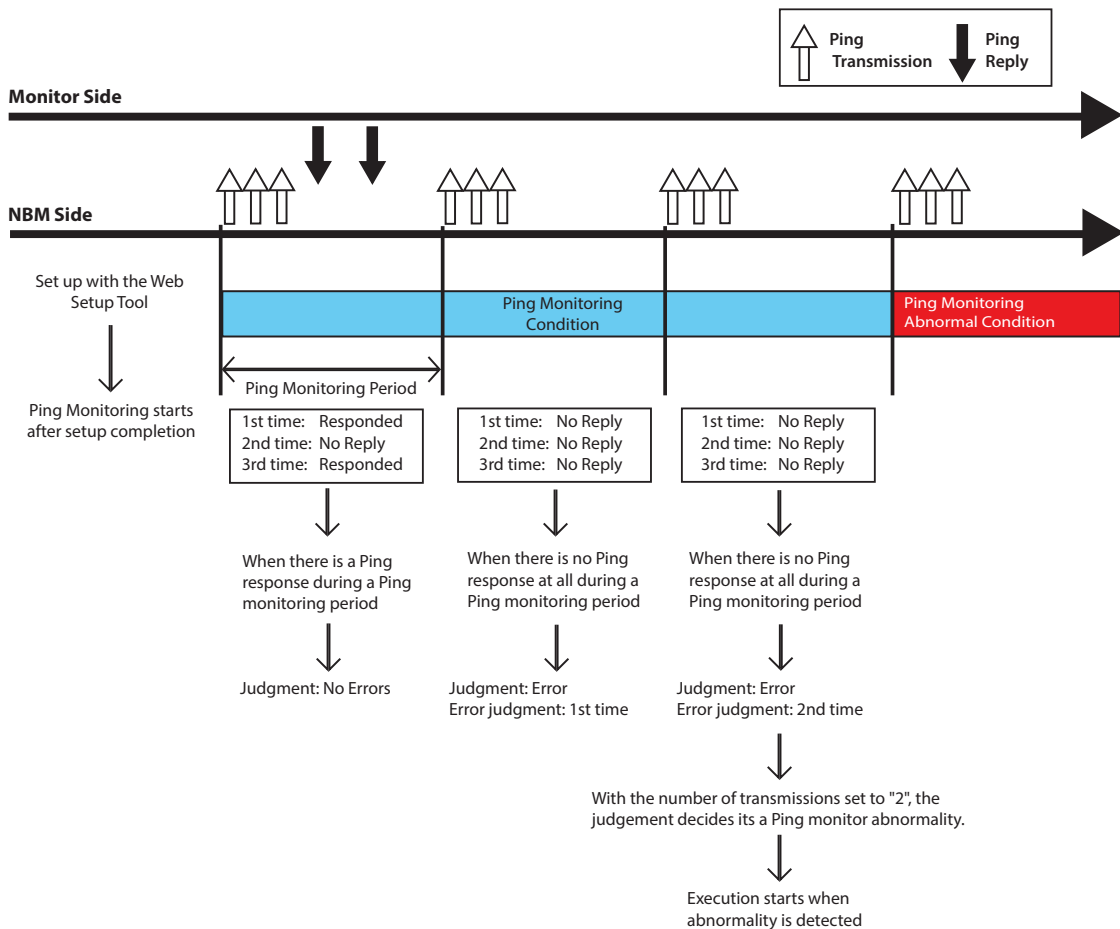

Fig. 3.9.1-1 detailed sample image for Cycle count Error threshold of "2" and Pings per test cycle at "3"

**Attention**

- When the abnormality recovery operation is performed, it is restored from the monitor abnormality status.
- When a clear operation (Execute a "Clear" operation from the Web setup tool, a "Clear" command via RSH-PRSH, PNS Command, or an SNMP clear) is made when a monitoring abnormality occurs, it will be restored to the monitoring condition.

### 3.9.2 Ping Monitoring Function (“Clear” Command Outside Sources)

A detailed explanation when a “Clear” operation is received (Executed a “Clear” operation from the Web setup tool, received “Clear” commands via RSH / PRSH, PNS Command, or an SNMP clear) from the outside by a monitor abnormality with the Ping monitoring function.

Example: When a clear command is received from the outside in the event of a Ping monitor abnormality

- ① When a monitoring abnormality occurs from the monitoring condition, the digital output operates at the time of the monitor abnormality.
- ② When a clear operation is received in a monitor abnormality status, the monitor abnormality status is cleared and it returns to the monitoring condition.
- ③ If there is a response at the next Ping monitoring, the monitoring condition will continue. If there is no response, the condition will immediately return to the abnormality detection mode.

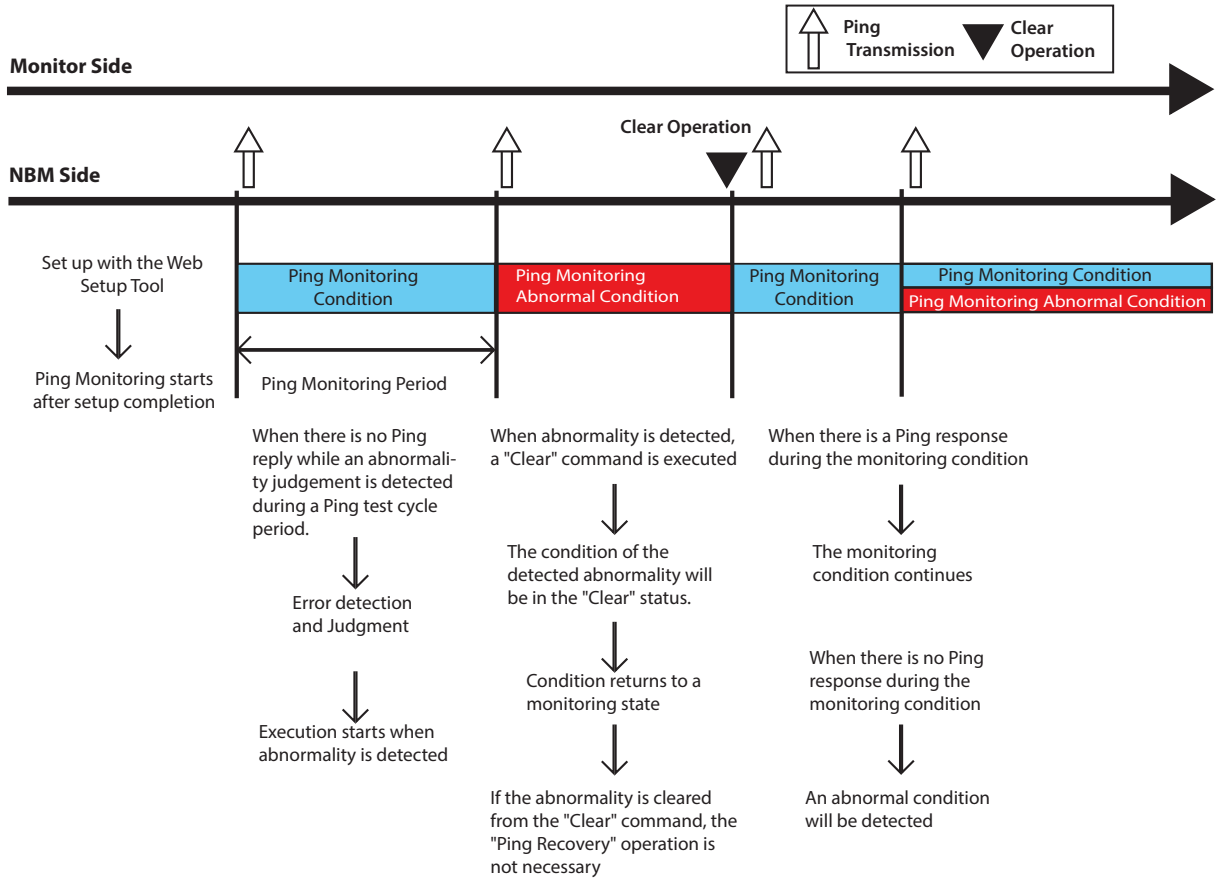

Fig. 3.9.2-1 Detailed sample of “Clear” operation received from the outside during monitor abnormality

**Attention** When a clear operation returns it to a monitoring condition, monitor abnormality restoration control does not occur.

3

### 3.10 Application Monitoring Function

By creating an additional send command to an application, this product can receive data from the application and can monitor the life and death of the application. If data is not received within the Ping test cycle period, a communication abnormality is judged, and a monitoring error sends a status change to the Signal Tower. After a generated event, if data is received from the monitored candidate, it will detect a recovery from the abnormal operation. For further details on the setting method, refer to “4.4 SNMP Configuration Screen” on pg. 66.

Example: When the monitor cycle is set at 30 seconds to monitor the data reception from the monitored application.

- ① After setting, the monitoring is started once it receives data from the address to be monitored.
- ② If data is received before the monitor cycle of 30 seconds elapses, it will be judged as having no abnormality.
- ③ If data can not be received within the next monitor cycle of 30 seconds from the judgment, it is judged as a monitor abnormality.
- ④ Once judged as abnormal, the operation at the time of the detected abnormality is carried out.
- ④ After a monitoring abnormality judgment, if data is received from the application to be monitored, it is judged as an abnormality recovery. The operation at the time of recovery from the abnormal condition will return to its monitoring condition again.

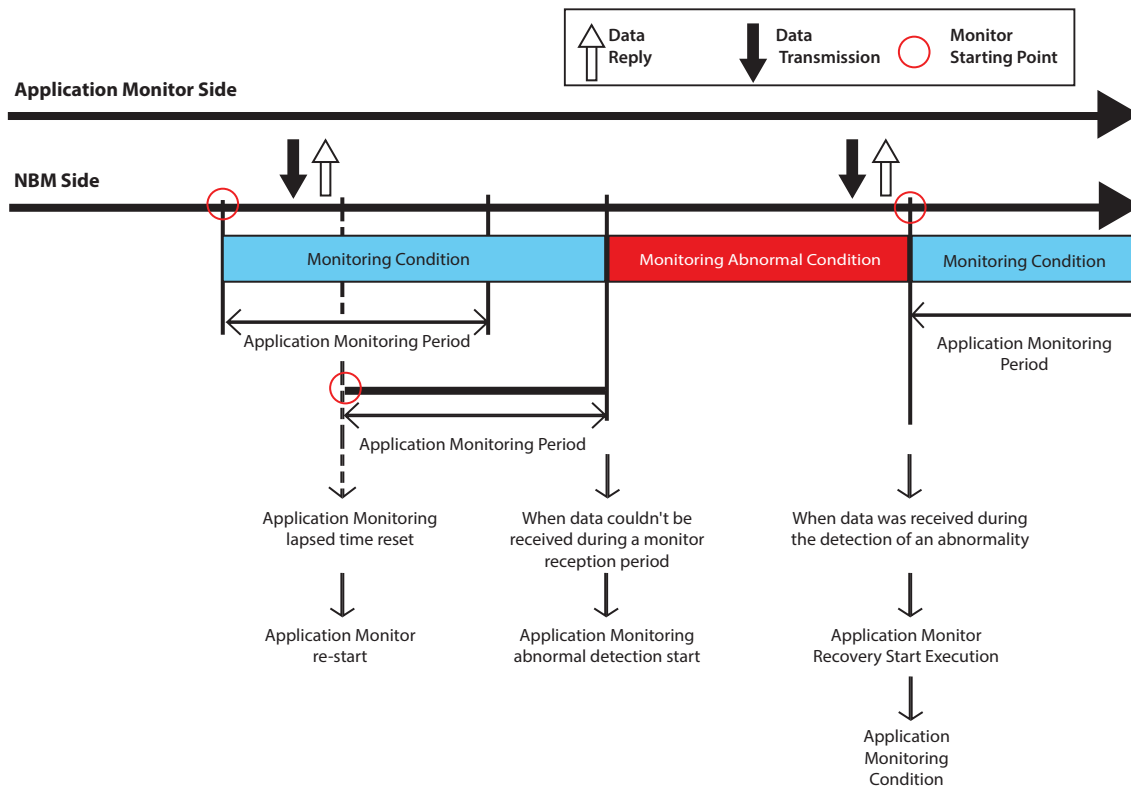

Fig. 3.10.0-1 Detail drawing of application monitoring operation example

**Attention**

- Monitoring starts from the time data is received.
- Terminating the connection will stop the monitoring.
- Recovery from an abnormal operation can only occur if a monitored condition was detected as abnormal.

### 3.11 Status Clear Function

A "Status Clear Function" is a function which changes each function of this product into the following status.

- For the digital output function, it sets all 8 ports to the OFF state.
- The test function turns off all digital outputs after execution.
- The digital input condition setting function erases the data for the number of accumulation times and the time stamp data.  
(When "Number of Detections" and "detection of durations" are set)
- The application monitoring function returns all the monitor abnormality conditions to the monitoring condition.
- The Ping monitoring function returns all the monitor abnormality conditions to the monitoring condition.

#### Attention

- Ports set as "Inactive" by "Digital Output Settings" are not cleared.
- Execution of a "Clear" operation actually turns off the output terminal block. Be very careful when executing a status clear.
- When the status clear function is executed in the monitoring condition, the monitoring condition is maintained as is.
- When returning to a monitoring condition, operation at abnormality recovery cannot be done. Moreover, when the monitoring object is still in an abnormal condition (No Ping Acknowledgement for the application monitor), in accordance to the monitor set up, the monitor abnormality operation is performed again.

There are five methods to execute a status "Clear" function.

- Execution from the Web setup tool (Refer to "4.21 "Clear" Operation Screen" on pg. 92)
- Execution of the RSH commands, "clear" and "doclear" (refer to "3.7.1 RSH Command Reception")
- Execution of an operation status clear command with the PNS Command (Refer to "3.5 PNS Command Reception Function" on pg. 33)

Product Category "XC"		Identifier "C"	(Open)	Data Size	
58H	43H	43H	00H	00H	00H

- Set the "clearAction" value to "1" with the SNMP SET command.  
(Refer to "3.3.1 SNMP SET Digital Output Control Function" on pg. 31)

Object	Object ID	Value
clearAction	1.3.6.1.4.1.20440.4.4.1.2.3.1	1

- Execution of the HTTP command, "clear".  
(Refer to HTTP Command Control)

### 3.12 "Clear" Switch Function

The clear switch function is the function to operate as follows, according to the setting when pressing the "Clear" button on the front of this product.

- Digital Output Control
- RSH Command Transmission
- Socket Transmission
- Trap Transmission
- E-mail Transmission
- Clear the number of times and time data during integration in the digital input condition setting.
- \* When the "operation at a clear switch depression" and "Condition Clear" from the "Digital Input Condition Settings" in the Web setup tool are "Active".

#### Attention

- When the clear switch is pressed during the monitor abnormality status, the monitor abnormality status is maintained.
- After the clear switch is pressed, no action will occur unless the monitoring object recovers from an abnormal condition.

### 3.13 Digital Input Condition Setup Function

The status change of a digital input condition is met when the set-up operation is set up to be executed. The digital input is detected as an ON condition. (Refer to "3.1.2 Digital Input Monitoring Function" on pg. 27) Condition "Setup 1" through "Setup 5" serves as independent control and judgment.

The sequence for operation setup is "Setup 1" -> "Setup 2" -> ---> "Setup 5", and when the setup agrees, the operation is executed. (Priority is given to the last set up operation)

The following set up can be executed.

Table 3.13.2-1 Condition Pattern

Pattern	Conditions
AND detection	It detects the input of the digital input ports 1-8 (up to four ports can be set).
Number of detection times	It is valid when detecting a certain number of inputs during the measuring time. The time which can be set for the measuring time is from 0 to 86400 seconds, or 99999 seconds. It does not operate when set to 0. When it is set for 99999 seconds, the time setting becomes unlimited, and the condition setting of only the predetermined number of times is set. The number of possible settings depends on the measuring time. When the measuring time is 1 second It is 0 to 4 times. When the measuring time is 2 seconds It is 0 to 8 times. When the measuring time is 3 seconds or more It is 0 to 10 times. It becomes invalid when it is set to 0.
Time Continuation Detection	When the fixed time input is set to be detected, it is considered as "Active." The settable number is from 0 to 86400 seconds. It is inactive when 0 is used.

Table 3.13.2-2 Operates when the "Clear" switch is pressed.

"Clear" Condition (For "Number of detection times", "Time Continuation Detection")	When the clear button is pushed, it is set up as to whether the measured number of detection times and count is erased. When set to "Active", an initialization will occur when the "Clear" switch is pressed. When set to "Inactive", there is no change, even if the "Clear" switch is pressed.
--	---

Table 3.13.2-3 Operation After Condition Agreement

Re-detection (For "Number of detection times", "Time Continuation Detection")	After a detection condition agrees, it is set up to detect again. When set to "does", it detects when detection conditions agree and operates. When set to "doesn't", after the setup, it only operates when the detection condition agrees at the beginning, and even if it agrees after that, it does not operate. To make it detect again, execute a "Clear" operation, or set up the "Clear" condition as "Active", and push the "Clear" switch.
---	---

Table 3.13.2-4 Condition Agreement Operation

Classification	Contents
Digital Output Control	The digital output will be ON or OFF.
RSH Command Transmission	The RSH command is sent to the device with the set-up address.
Socket Transmission	The registered command is sent to the device with the set-up address.
Trap Transmission	The SNMP trap is sent to the device with the set-up address.
E-mail Transmission	E-mail is transmitted to the set-up mail server.

**MEMO**

- The detection delay for a digital input is 110 ms.
- The input trigger condition cannot be changed from a fixed on condition.

### 3.14 Reinitialization Function

From the Web Setup Tool, this unit can be reinitialized to revert all settings back to the default (factory) settings, while leaving the network settings as is when resetting the other settings. Refer to "4.18 Reinitialization Setup Screen" on pg. 89 for the details of the operation method. The switch on this product can also be operated by the following methods, and only the network setup can be initialized to the factory default values. Refer to "3.21 Mode Switching Functions" on pg. 51 for the details of the operation method.

**[Method for initialization, including the network setup]**

- ① Set the mode selector switch to "3".
  - ② Turn on the power of this product again or press the reset switch.
  - ③ Make sure port 3 of the input display LED is flashing, then press the select switch.
  - ④ Initialization is executed and lights switch on in sequence from port 1 of the input display LED.
  - ⑤ When all the input display LEDs and output display LEDs are in a lighted state, initialization is complete.
  - ⑥ Turn off the power, then turn the mode switch to "0."
  - ⑦ Turn on The Main Unit and connect with the factory default IP address at "192.168.10.1."
- \* If the Ping monitor etc. are set up, an abnormal operation detection may occur.  
 \* If port 1 of the output display LED lights up, initialization has failed.

**[Method for initialization, reverting back to default values]**

- ① Set the mode selector switch to "4."
- ② Turn on the power of this product again or press the reset switch.
- ③ Check that the display LED of Port 4 is flashing, then press the select switch.
- ④ Initialization is executed and lights switch on in sequence from port 1 of the input display LED.
- ⑤ When all the input display LEDs and output display LEDs are in a lighted state, initialization is complete.
- ⑥ Turn off the power, then turn the mode switch to "0."
- ⑦ Turn on the Main Unit and connect with the factory default IP address at "192.168.10.1."

Table 3.14.0-1 Setting after default function executed

Item	Execution Method				
	WEB Setup Tool		Mode Switch Functions		
	When checking with the network initialization	When not checking with the network initialization	No.4 Factory default	No.3 network setting initialization	No.7 password initialization
Network Setup	Set to default value	Setting is Saved	Set to default value	Set to default value	Setting is Saved
Password	Set to "patlite"	Set to "patlite"	Set to "patlite"	Set to "patlite"	Set to "patlite"
Setup Menu (Except password/network item)	Set to default value	Set to default value	Set to default value	Setting is Saved	Setting is Saved
Operation Settings	Set to default value	Set to default value	Set to default value	Setting is Saved	Setting is Saved
Status/Operation Log	Erased	Erased	Erased	Retain value	Retain value

**Attention**

- Do not overexert pressure to the "Clear" switch, select switch or mode switch.
- Configuration data or logs deleted in "Network setting initialization mode" or "Factory setting mode" can not be restored. Before initialization, be sure to backup any necessary setup information and log data.

**MEMO**

- "Network setting" refers to the "main unit IP address, netmask, default gateway, DNS server address, host name, domain name" items on the system setting screen.



### 3.15 Configuration Data Save/Load Setup

The setting items of this product can be read and saved onto the PC or a USB memory as configuration data. Also, the configuration data can be selected and it can loaded into this product.

The Configuration Save/Load Setup can be done from the Web setup tool, or by the use of the switches on this product. The configuration data can be read or saved to the PC through the use of the Web setup tool. Refer to "4.23 Configuration Data Setup Screen" on pg. 94 for details.

When operating the switch of this product, changing modes with the changeover switch can be used to read the configuration data onto a USB memory, then writing that configuration data saved in the USB memory into this product.

For details, refer to "4.23 Configuration Data Setup Screen" on pg. 94 and "3.21 Mode Switching Functions" on pg. 51.

Table 3.15.0-1 Read and Write Configuration Data Contents

Network Setup	×
Password	×
Setup Menu (Except password/network item)	○
Operation Settings	○
Status/Operation Log	×



### 3.16 Status Log Function

This product can store the digital input/output status log in the flash memory inside this product. The saved status log can be checked and downloaded via the Web setup tool.

A download can be exported as a CSV file, or can be saved to the USB memory connected to the USB connector output of this product. Refer to "3.20 USB Memory Function" on pg. 50 for details.

Table 3.16.0-1 Status Log Function (Specifications)

Output Method	Polling/Event Method
Download file's default file name	nbm-statlog.csv
Number of storable logs	100,000 cases (An overdelivery is deleted in order of oldest)

**[Status Log Format]**

Date\_time, digital input status (8 figures of comma separated values), digital output status (8 figures of comma separated values)

**[Status Log Format]**

2012/12/13 17:16:38,1,0,0,0,1,1,0,1,1,1,0,1,0,0,1,0

Table 3.16.0-2 Status Log (Output Contents)

Item	Contents
Date and Time	It is the recorded date and time of log data.
Digital input status	It shows the logical value of each port of the digital input. 0: OFF 1: ON
Digital Output Status	It shows the logical value of each port of the digital output. 0: OFF 1: ON

Conditions to save the status log can be selected from the "polling" or "event" method.

Table 3.16.0-3 Status Log Output Method

Output Method	Description
Polling Method	Preset to save the status log at intervals. The time intervals which can be set up is from 1 to 300 seconds.
Event Method	Each time the digital input/output status changes, the status log is saved.

### 3.17 Operation Log Function

This product can store the operation log of the created event, etc., in the flash memory inside this product. The saved operation log can be checked and the contents downloaded via the Web setup tool.

The download can be exported as a TXT file, or stored onto a USB memory from the USB connector. It can also be transmitted to another host via the network. Refer to “3.20 USB Memory Function” on pg. 50 for details.

- MEMO**
- In order to transfer the operation log to the host, the “syslog server” must be running on the host side.
  - The UDP port No. 514 is used for log transfer.
  - The destination of the operation log can be checked from the Web Setup tool. Refer to “4.1 System Setup Screen” for the details of the Setup method.
  - When an event occurs, the log is stored inside the product, and it is transferred at the same time to the set host.
  - The format of the log transferred to the host is in syslog format, not the operation log format.

Table 3.17.0-1 Operation Log Function Specifications

Download file's default file name	nbm-actlog.txt
Number of storable logs	50,000 cases (An overdelivery is deleted in order of oldest)

**[Operation Log Format]**

**date time host name log type: -- message 1[-- :message 2]**

**[Operation Log Display Example]**

**Jan 1 01:23:45 hostname START:system started**

Table 3.17.0-2 Operation Log Output Contents

Log Type	Message 1	Message 2	Description
START	system started	Version host name	It exports when this product is starting up.
MAIL	send mail	—	It exports when sending an E-mail.
PING	error occurred	Error occurrence target address	When a Ping monitoring error occurs, it is recorded together with the address of the target device.
	error recovered	Error recovery target address	When a Ping monitoring error recovery occurs, the address of the target device is recorded.
APL	error occurred	Error occurrence IP address Port number	It records when an application monitoring error occurs.
	error recovered	IP address Port number to be restored	It will be recording when restoring an application monitoring error.
TRAP	received	Designated sender IP address reception OID (specific-trap value)	When the registered trap is received, it is recorded together with the designated sender IP address.
CLEAR	clear button	—	It records when the “Clear” button of this product is pushed.
	snmp command	—	It records, when a clear operation is executed with the SNMP Set.
	rsh command	IP Address	It records when a clear is executed by the RSH command.
	web tool	—	It records when the clear operation is executed from the Web setup tool.
	pns command	—	It records when a “CLEAR” has been executed by the PNS Command.
	http command	—	It records when a “CLEAR” has been executed by the HTTP Command.
RSH	Command Name	IP Address	It records when the RSH Command is executed. (Except the “Clear” command) * When the designated sender address is invalid, the IP address is not displayed.
SNMP	digital output was controlled	Operated digital output (DO1-DO8)	It records when a digital output is operated by the SNMP Set command.
DIN	digital input state change ON	Operated digital input (DI1-DI8)	It records when the digital input operates.
	digital input state change OFF		
DOUT	digital output state change ON	Operated digital output (DO1-DO8)	It records, when the digital output operates.
	digital output state change OFF		
CONDON	matched the condition setting	Matched Number	It records when the conditions set up by the condition function matches.
HTTP	command	Parameter	It records when the HTTP Command is executed. (Except the “clear”).



### 3.18 Firmware Update Function

The Firmware Update can be done from the Web setup tool, or by the use of the switches on this product. When using the Web setup tool, the firmware can be saved onto the PC etc., and selected to be updated from there. Refer to "4.22 Firmware Update Screen" on pg. 93 for details.

When updating the firmware from the USB memory connected to this product, the switch on this product can be used to execute the firmware update. For details, refer to "3.20 USB Memory Function" on pg. 50 and "3.21 Mode Switching Functions" on pg. 51.

### 3.19 XML Data Output Function

The digital output status for this product is acquirable from an XML data format. Two kinds of XML data acquisition methods are indicated below.

- Access the URL of `http:// IP address / cgi-bin/get_xml.cgi` to get the data.
- Download the XML file from the "XML Data" screen of the Web setup tool.

**MEMO**

- When XML data is acquired, set up the XML file output to "Active".
- When accessing the URL to acquire XML data, login certification can be made. Except for when using it in a safe Network, it is recommended to use the login certification when considering security.
- Refer to "4.26 XML data screen" for more details.

XML data can be obtained in the format shown below:

```
<?xml version="1.0" encoding="utf-8"?>
<server>
<port>
<port name="DIN-1" value="0"/>
<port name="DIN-2" value="0"/>
<port name="DIN-3" value="0"/>
<port name="DIN-4" value="0"/>
<port name="DIN-5" value="0"/>
<port name="DIN-6" value="0"/>
<port name="DIN-7" value="0"/>
<port name="DIN-8" value="0"/>
<port name="DOUT-1" value="0"/>
<port name="DOUT-2" value="0"/>
<port name="DOUT-3" value="0"/>
<port name="DOUT-4" value="0"/>
<port name="DOUT-5" value="0"/>
<port name="DOUT-6" value="0"/>
<port name="DOUT-7" value="0"/>
<port name="DOUT-8" value="0"/>
</port>
</server>
```

Fig. 3.19.0-1 XML data format for digital output

Table 3.19.0-1 XML Data Item Explanation

Classification	Description
port name	The digital input/output port is shown. DIN-1 - DIN-8: digital input ports 1 to 8 DOUT-1 - DOUT-8: digital output ports 1 to 8
value	The status of each port is shown. 0: OFF 1: ON

## 3.20 USB Memory Function

By connecting a USB memory to the USB connector on the front of this product, firmware updates, log storage, and configuration data uploads and downloads can be done.

### Attention

- Prior to connection, it is necessary to format the USB memory in form of FAT or FAT32 for appointed folder structuring.
- The USB memory cannot be partitioned.
- If a USB-HUB is used, it may not operate properly.
- After connecting a USB memory to this product, wait about 5 seconds for connection for it to be recognized. The time until it is recognized depends on the type of USB memory which is being connected, and may take longer.

Functions which can be done, using USB memory

Table 3.20.0-1 USB Memory Operation Functions

Functions	Details
Firmware update function	Firmware updates can be done from the USB memory. Change the firmware update file name into "nbm_update" before executing the update.
Status Log function	A status log can be downloaded onto USB memory. The file name to download is "nbm-statlog.csv."
Operation Log Function	An operation log can be downloaded to USB memory. The file name to download is "nbm-actlog.txt."
Configuration Save/Load Setup Function	Configuration data can be uploaded to this product from USB memory. The upload configuration file name is "nbm_w.ini." Configuration data can be downloaded from the Main Unit to the USB memory. The download configuration file name is "nbm.ini."

USB memory Folder structure

In order to use the USB memory for this product, build the following folder structure.

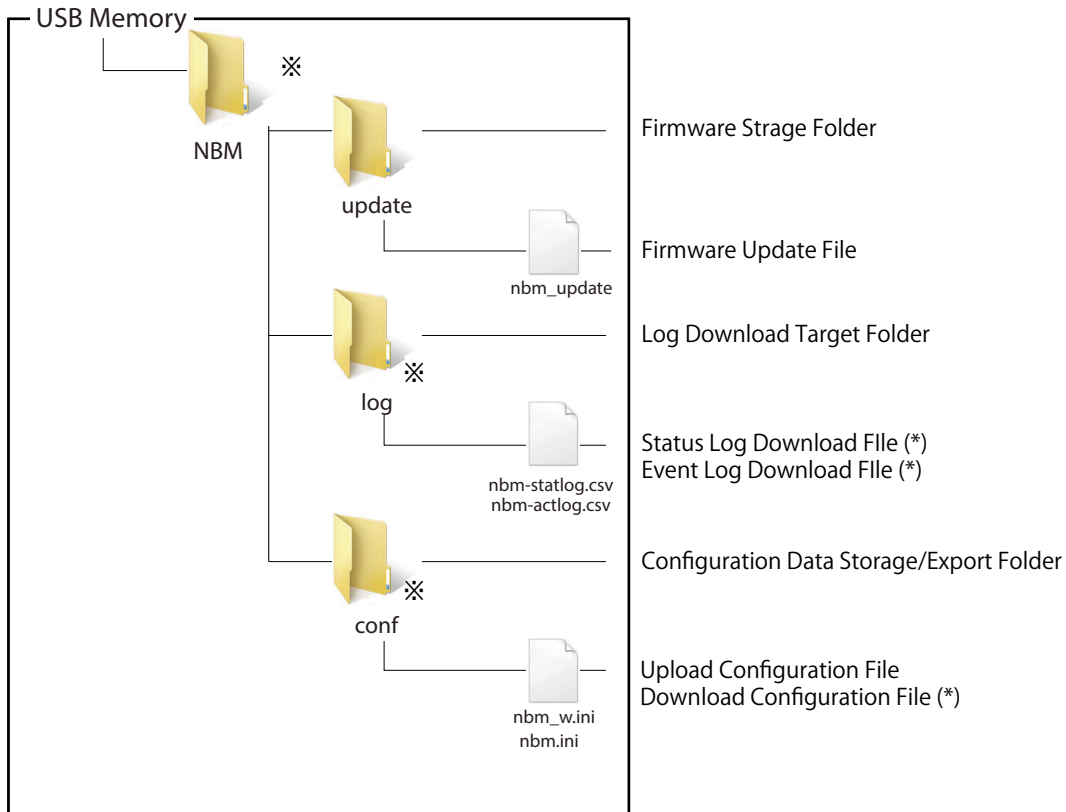

Fig. 3.20.0-1 USB Memory Folder Structure

※ The folder and files marked with an asterisks are automatically generated, when each data file is downloaded.

### Attention

- Enter the USB memory folder name and file name, using half-width alphanumeric characters. Since it is case sensitive, refer to Fig. 3.20.1. when entering folder and file names.

## 3.21 Mode Switching Functions

The mode switch on the front of this product can be operated by changing the operational mode of this product. Use the mode switch when the Web setup tool cannot be used.

To change the mode, after switching the mode switch, turn the power to this product on again, or press the reset switch on the front of this product to restart.

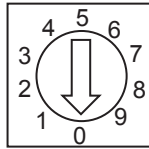

Fig. 3.21.0-1 Mode Switch

※ Use the following tools to operate the mode switch.

Name	Tolerable Dimensions
Minus Driver	Blade diameter 1.8-2.1 mm Width 0.7-0.8 mm

Table 3.21.0-1 Operational Mode List

MEMO

- If a screwdriver with an improper dimension is used, or any screwdriver other than a minus screwdriver, the driver groove on the lever part of the terminal may be damaged, causing operation to become impossible.
- The flat blade should be applied vertically to the driver groove. If it is at a slant, there is a possibility that the lever part will be damaged.
- Do not apply excessive strength to the lever section.

Table 3.21.0-2 Operational Mode List

Mode Switch No.	Mode	Details
0	Normal Mode	It is a normal operation mode. All functions of this product will work.
1	Configuration Download Mode	Configuration data can be downloaded to USB memory.
2	Configuration Upload Mode	Configuration data can be uploaded to USB memory.
3	Network set-up initialization mode	By pressing the selection switch, the network setting and password are reset to the initial state and the log is deleted.
4	Factory Default Mode	By pressing the selection switch, the setting status including the network is returned to the initial state and the log is deleted.
5	Reserved	Each function will not operate, even if it is set as a reserved number.
6	Upgrade mode	Pressing the selection switch can start the update from the USB memory.
7	Password Initialization Mode	By pressing the selection switch, the password can be returned to the initial state (patlite).
8	Reserved	Each function will not operate, even if it is set as a reserved number.
9	Reserved	Each function will not operate, even if it is set as a reserved number.

Attention

Configuration data or logs deleted in "Network setting initialization mode" or "Factory setting mode" can not be restored. Before initialization, be sure to backup any necessary setup information and log data. Firmware Ver 2.00 or later cannot be downgraded to less than Ver 2.00 firmware.

## << Log Acquisition Mode >>

The USB memory is connected during the Normal Mode (No.0):

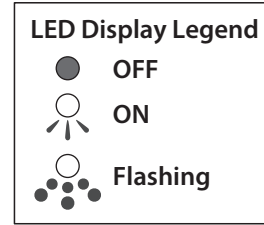
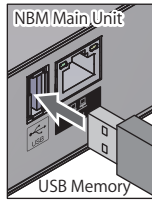

Conditions are displayed by the status LED.



Press the selection switch.

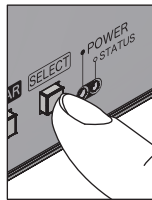

Status LED flashes at a high speed.



Task Completed.



Remove the USB memory.

Error Occured

Status LED flashes at a low speed.



Press the selection switch.

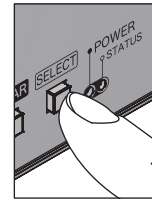

The power LED and status LED light up.



Remove the USB memory.  
(The log is not acquirable)

3

## << Configuration Download Mode >>

A mode switch is set as "configuration download mode" (No.1), and starts as:

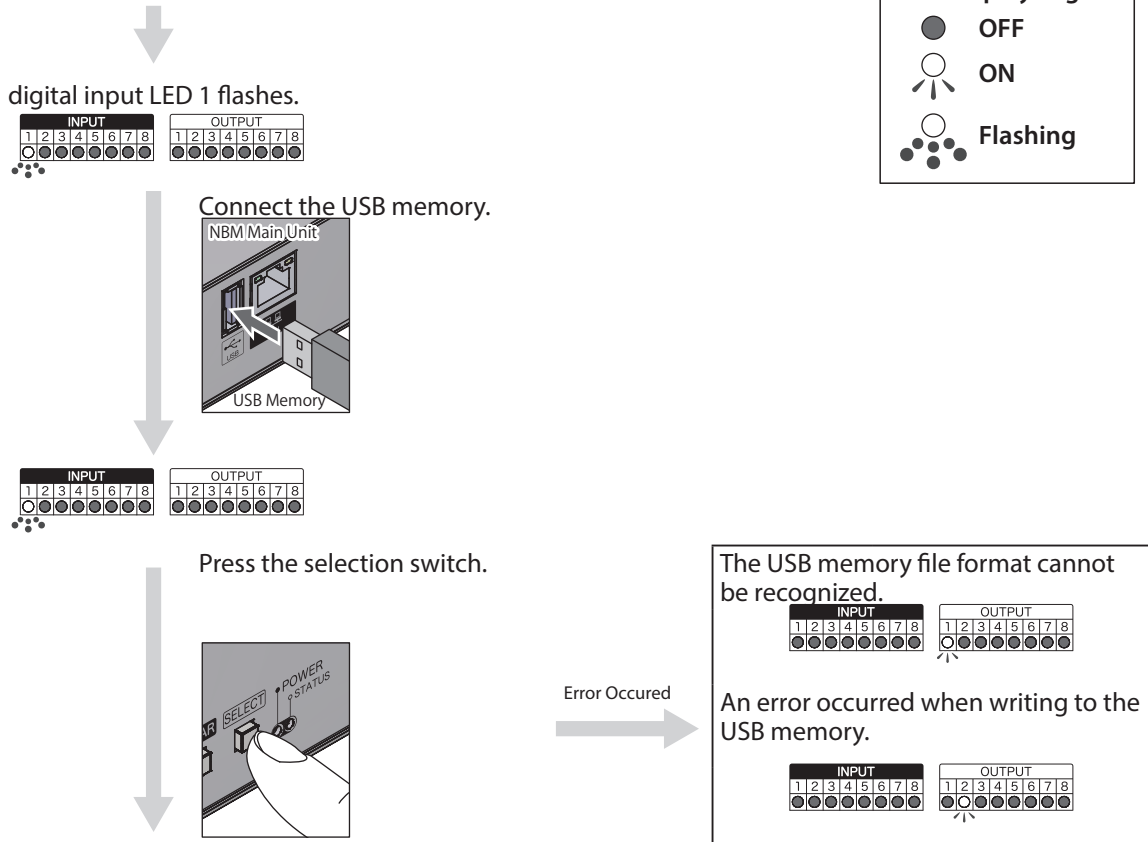

3

Lights switch on sequentially, starting from digital input 1.

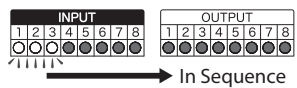

Task Completed.

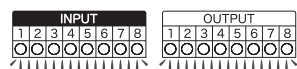

Remove the USB memory.

Return the mode switch to the normal mode (No.0), then reboot.

## << Configuration Upload Mode >>

A mode switch is set as "configurations upload mode" (No.2), and starts as:

digital input LED 2 flashes.

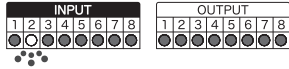

Connect the USB memory.

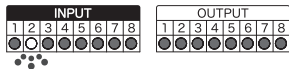
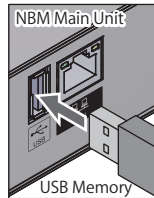

Press the selection switch.

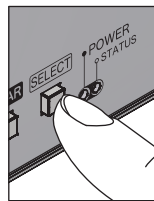

Lights switch on sequentially, starting from digital input 1.

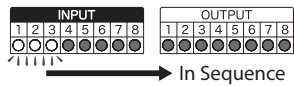

Task Completed.

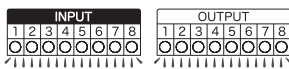

Remove the USB memory.

Return the mode switch to the normal mode (No.0), then reboot.

### LED Display Legend

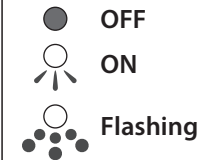

The USB memory file format cannot be recognized.



The USB memory does not contain any data.

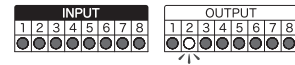

The configuration data is incorrect.

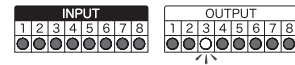

Error Occured

3

## << Network Setup Initialization Mode >>

By setting the mode switch to Network Setup Initialization Mode (No.3), the startup is:

digital input LED 3 flashes.

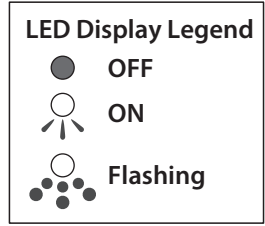
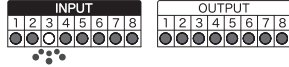

Press the selection switch.

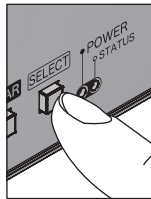

Lights switch on sequentially, starting from digital input 1.

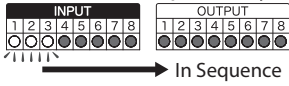

Task Completed.

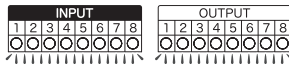

Remove the USB memory.

Return the mode switch to the normal mode (No.0), then reboot.

3

## << Factory Setup Mode >>

By setting the mode switch to Factory Setup Mode (No.4), the startup is:

digital input LED 4 flashes.

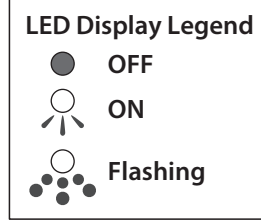
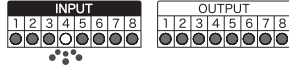

Press the selection switch.

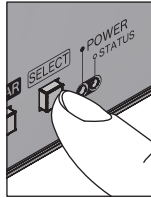

Lights switch on sequentially, starting from digital input 1.

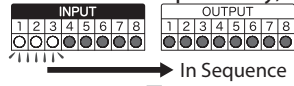

Task Completed.

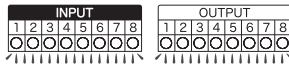

Remove the USB memory.

Return the mode switch to the normal mode (No.0), then reboot.

3



## << Version Upgrade Mode >>

By setting the mode switch to "version upgrade mode" (NO.6), it starts as:

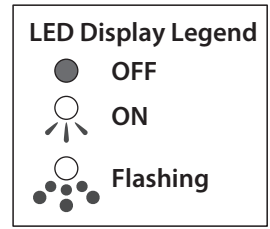

digital input LED 6 flashes.

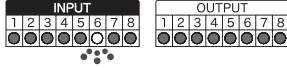

Connect the USB memory.

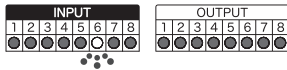
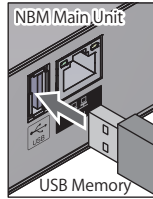

Press the selection switch.

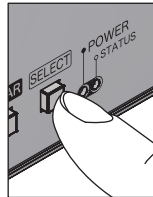

Error Occured

The USB memory file format cannot be recognized.

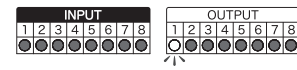

The USB memory does not contain any data

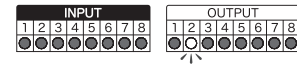

Firmware update failed.

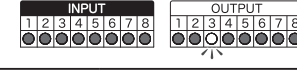

Lights switch on sequentially, starting from digital input 1.

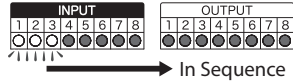

Task Completed.

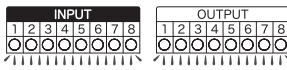

Remove the USB memory.

Return the mode switch to the normal mode (No.0), then reboot.

## << Password Initialization Mode >>

A mode switch is set as "Password Initialization Mode" (No.7), and starts as:

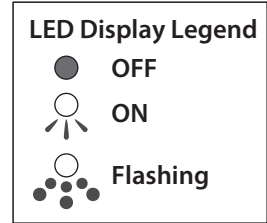
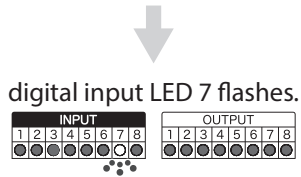

Press the selection switch.

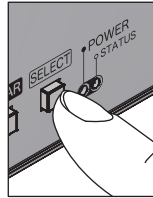

Lights switch on sequentially, starting from digital input 1.

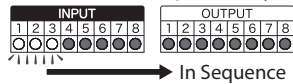

Task Completed.

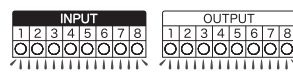

Remove the USB memory.

Return the mode switch to the normal mode (No.0), then reboot.

### 3.22 "Reset" Function

Pressing the "Reset Switch" located on the front of this product will execute a power source reset. A switch is located inside the hole of the front panel of this product to prevent any unintentional reset from occurring. Use a wire with the diameter of about 1 mm (such as a paper clip), and push it inside the hole to press the internal switch.

#### Attention

- Do not exert excessive force when pushing the button. Failure to comply may damage the unit.
- When the reset switch is pressed, it will cause the product to reboot, but all terminal outputs become open during that time. Be careful when resetting the product, only perform this step when it is an unavoidable situation.
- Part of the status log and operation log data may be lost without saving before pressing the reset switch. If the log is required, be sure to backup before pressing the reset switch.

## 3.23 HTTP Command Control Function

This product can be controlled by transmitting a HTTP command from the HTTP client. In the System Configuration Screen, "Active" or "Inactive" of this function can be set.

[Specification of HTTP command control]

Protocol	HTTP	
Method	GET	
Syntax	http://<IP address>/api/control?<parameter name>=<value>	
Response	Success.	This message is returned when the control was successful.
	Error. [Error code]	This message is returned when the control was unsuccessful.

Error code	Description
001	Unsupported Method.
002	No such parameter name.
003	Parameter is not specified.
004	Parameter value is not specified.
005	Illegal parameter values.

Parameter	Values	Description
alert=< integer value >	8 digits	Digital output can be controlled. Specify the pattern in order of [ DO 1 - DO 8 ] OFF "0", ON "1", no operation "9" are entered.
clear=< integer value >	1	All digital outputs are turned OFF and change from the monitoring abnormal condition to the monitoring condition. The values (time and number) accumulated in the input condition setting is erased.

### Attention

When using the HTTP Command Control function, set "HTTP Command Control Function" to "Active" on System Configuration Screen.  
Refer to "4.1 System Configuration Screen"

### 3.23.1 Example

<alert>

When operating "Port 1 ON; Port 3 OFF; others not operating."

<http://192.168.10.1/api/control?alert=19099999>

When operating "Port 1 - 3 ON; Port 4 - 6 no operation; Port 7 and 8 OFF."

<http://192.168.10.1/api/control?alert=11199900>

<clear>

All digital outputs are turned OFF and change from the monitoring abnormal condition to the monitoring condition.

<http://192.168.10.1/api/control?clear=1>

# 4. Function Setup

The function setup is available in order to take advantage of the various functions. To access the settings, click the setup items on the left-hand side of the Web Setup Tool to open the set up screen for the various functions.

Table 4.0.0-1 Function List

Setup Category	Setting Screen	Setup Contents
Setup Menu	System Configuration	Sets up the network parameters.
	User Authorization Configuration	Sets up the login password for this product.
	Clock Settings	Sets up the clock's time for this product.
	SNMP Configuration	The Setup of SNMP SET/GET and a trap transmission function is performed.
	E-mail Settings	Sets up the e-mail transmissions for this product.
	E-Mail Message Settings	Setup for writing the message contents to be transmitted by E-mail.
	RSH Command Transmission Configuration	Set up the RSH command destination and the command.
	RSH Command Reception Configuration	Sets up the RSH command for receiving.
	Socket Transmission Configuration	Set up the command destination, the sending port, and command.
	Socket Reception Configuration	Sets up the ports to receive the PHN and PNS Commands.
Operation Setup Index	Digital Input Setup	Each digital input can be set up.
	Digital Output Setup	Each digital output can be set up.
	Trap Reception Configuration	Set up traps that allow trap reception and the operation after the trap has received a transmission.
	Application Monitoring Configuration	The setup of the address for the monitored equipment and the management when an abnormality and abnormality recovery is detected.
	Ping Monitoring Configuration	The setup of the address for the monitored equipment and the management when an abnormality and abnormality recovery is detected.
	"CLEAR" Button Setting	Set up the digital output, command transmission and E-mail transmission when pressing the "Clear" button.
	Digital Input Condition Settings	Set up for the digital input conditions and the operation when condition agreements occur.
Main Unit Operation Index	Reinitialization	The settings return to factory default values.
	Reboot	After settings have been changed, in order to put them into effect, this product is rebooted.
	Digital Output Operation	The digital output operation is set up.
	"Clear" Operation	"Clear" Operation
Maintenance Function Index	Firmware Update	The Firmware can be updated with this function.
	Configuration Data Setup	Set up to save the config data items and be reloaded at any time.
Information Reference Index	Status Log	The status log can be download and checked.
	Event Log	The event log can be downloaded and checked.
	XML Settings	TheXML data Output can be set and the data downloaded.

**Attention** After completing the desired setup configuration, reboot this product by pressing the "reset" button, or removing the power for a few seconds and reapplying it for the changes to take effect.



## 4.1 System Configuration Screen

The network parameters for this product can be setup through a browser. The default IP address is "192.168.10.1". The parameters can be setup from the System Configuration Screen (Fig. 4.1.0–1 System Configuration Screen) from the default values as shown in Table 4.1.0–1.

Fig. 4.1.0–1 System Configuration Screen

Table 4.1.0–1 System Configuration Parameters

Item	Contents	Default Value	Input Parameter	Setup Option
System Name	The name for this product can be set.	NBM-D88	Full/Half width Characters; Max. 31 Characters	O
System Location	The setup location of this product can be entered.	Blank	Half-width alphanumeric characters and underscore "_": Max. 31 Characters	O
Contact Address	Setup the contact address.	nbm@patlite.jp	Mail address format; Max. 63 Characters	O
Log Host Address	Set up the operation log destination.	Blank	Host name or IP address format; Max. 63 Characters	O
IP Address Configuration Method	The method for setting up the IP address to this product as manual or automatic is selected.	Setup Manually	—	—
IP Address	Setup the IP address of this product.	192.168.10.1	IP Address Format	x
Net Mask	Setup the subnet mask of this product.	255.255.255.0	IP Address Format	x
Default Gateway	Setup the default gateway of this product.	0.0.0.0	IP Address Format	O
DNS Server Address	Setup the DNS server of this product.	0.0.0.0	IP Address Format	O
Host Name	Set up a host name	nbm.patlite.jp	The host name, or host name IP address format, and the domain name can be a maximum of 62 characters in all.	x
Domain Name	Set up the domain name.	Blank		O
HTTP command control function	Select "Active" or "Inactive" for the HTTP command control function.	Active	—	—

\* The "Setup Option" indication is explained below to indicate in the diagram whether a value input is omissible (a blank is used) or not.

The "O" indicates where it is omissible.

The "x" indicates where is not omissible, or is selected from an item menu. Be sure to enter a value.

The place where "-" is written cannot be omitted, or becomes the item to set by selecting the item. The value has to be entered in accordance to the customer's environment.

## 4.2 User Authorization Configuration Screen

Setup a password to log into the Setup Screen for this product. The next time for logging in will ask for the new password.

The set up password to be used can be up to 16 half-width alphanumeric characters and a "." (period). Table 4.2.0-1 shows the item to be set up on the user authentication screen.

### [Setup Method]

- ① Enter a new password in the "Password" field.
- ② Enter the new password again in the "Re-enter Password" field.
- ③ Click the "Set" button to activate the setup.

Log in with the new password the next time a login screen appears.

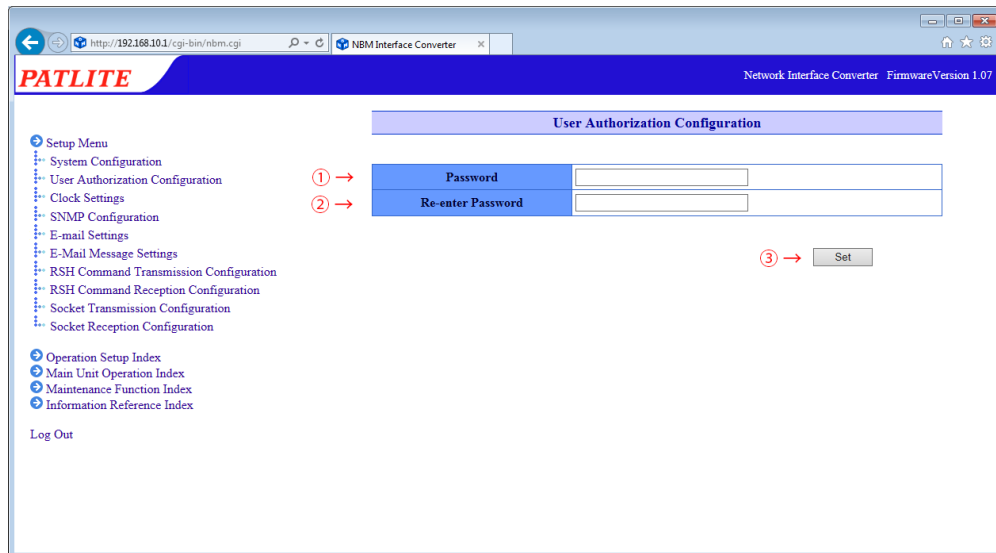

Fig. 4.2.0-1 User Authorization Configuration screen

Table 4.2.0-1 User Authorization Configuration Parameters

Item	Contents	Default Value	Input Parameter	Setup Option
Password	Enter a new password.	Blank	A half-width alphanumeric character and period; Max. 16 Characters	X
Re-enter Password	Re-enter the new password for confirmation.	Blank	A half-width alphanumeric character and period; Max. 16 Characters	X

## 4.3 Clock Settings Screen

The clock setup for this product can be done through a browser. The items set on the time setting screen are shown in Table 4.3.0–1.

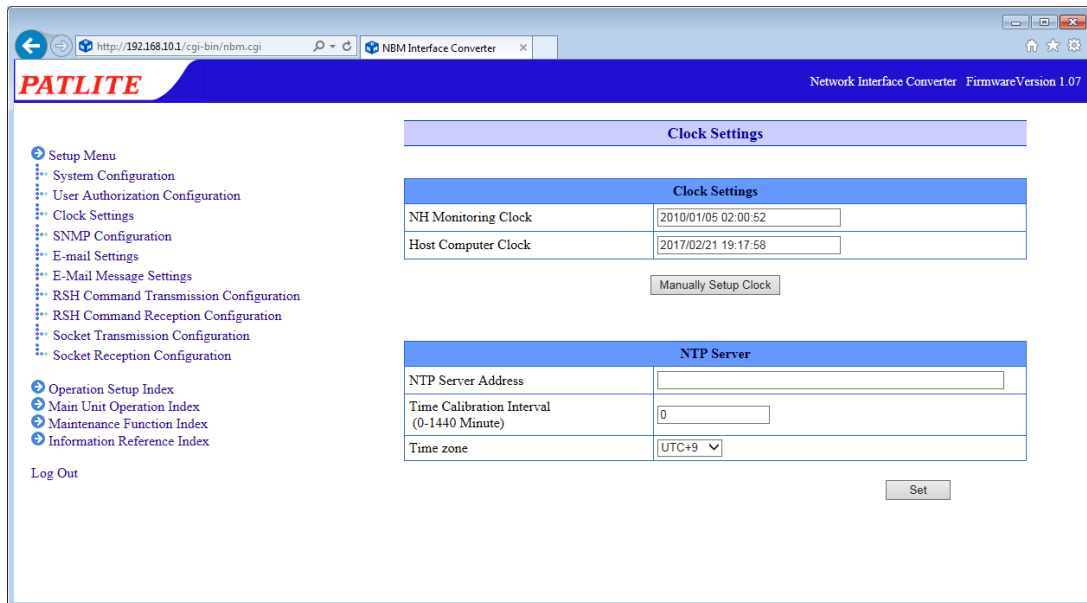

Fig. 4.3.0–1 Clock Settings Screen

Table 4.3.0–1 Clock Settings Parameters

Item	Contents	Default Value	Input Parameter	Setup Option
NTP Server Address	Set the NTP server address.	Blank	Host name or IP address format: Max. 63 Characters	○
Time Calibration Interval	Sets the interval to communicate with an NTP server.	0	Half-width numbers from 0-1440 (minutes)	○
Time zone	Setup the time zone.	UTC+9	—	—

Two kind of clock setup methods are indicated below:

- The PC clock's time is reflected in this product.
- It communicates with an NTP server and corrects the time of this product.

### 4.3.1 PC Clock Synchronization

When the “Manually Setup Clock” button is clicked, the time of the logged-in PC will be reflected in the time of this product.

**[Setup Method]**

- ① Compare the columns between the “NH Monitor Time” and the “Host Computer Time”.
- ② Click the “Manually Setup Clock” button to synchronize the time with the PC which is logged in.

**Attention**

- In some cases, this product may not reflect the exact time as the PC, and the clock may be off by several seconds.
- When not using an NTP server, periodically check the clock on this product.
- This product uses a capacitor as a battery backup for the time stamp.  
Depending on the charge status of the capacitor, it may last up to a half-day, and if the power supply is not applied during the day, a gap in time or the need to reset the clock may be necessary. If an application environment requires a time entry, be sure to set up the time before the application.
- If the backup is depleted and the time entry resets, the set time will be labeled as “Jan 1, 2010”.

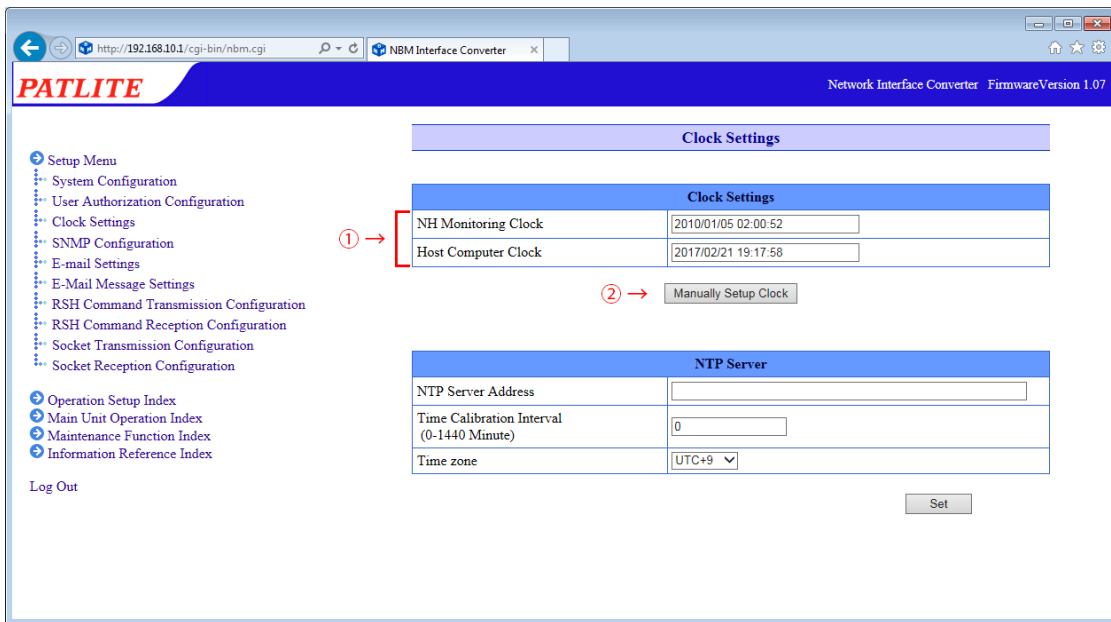

Fig. 4.3.1-1 Setup Screen before “Manually Setup Clock” button is clicked

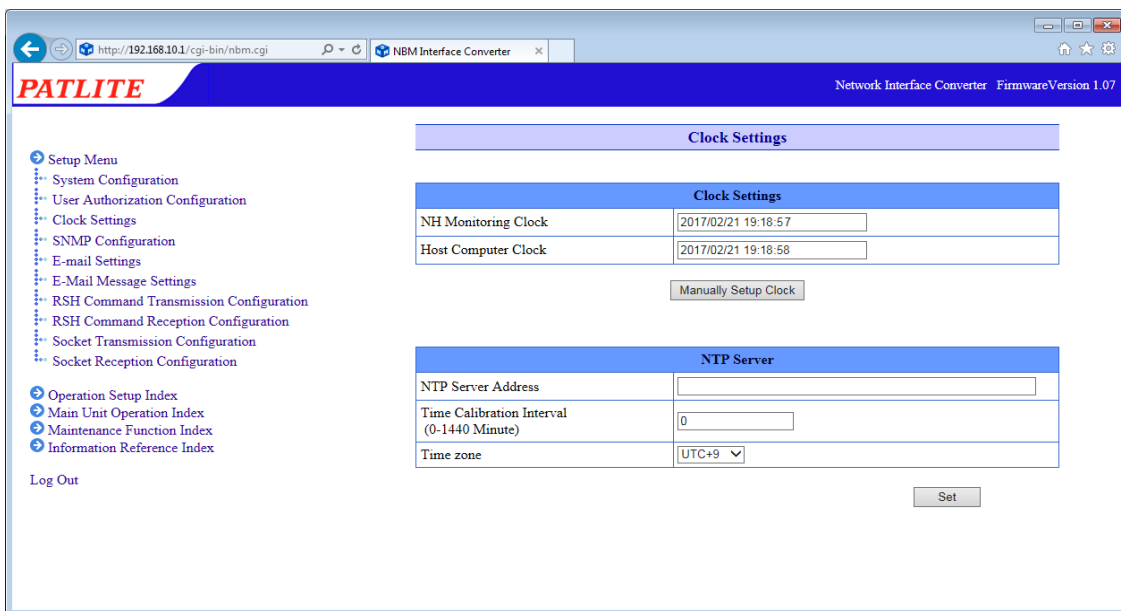

Fig. 4.3.1-2 Setup Screen after “Manually Setup Clock” button is clicked



### 4.3.2 Synchronizing with an NTP server

An NTP server can be linked by entering the NTP server address to synchronize with the clock in this product.

**[Setup Method]**

- ① Enter the NTP server address in the “NTP Server Address” column.
- ② In the “Time Calibration Interval” field, enter between 0 and 1440 minutes for the interval to communicates with an NTP server.
- ③ Click the “Set” button to activate the setup.

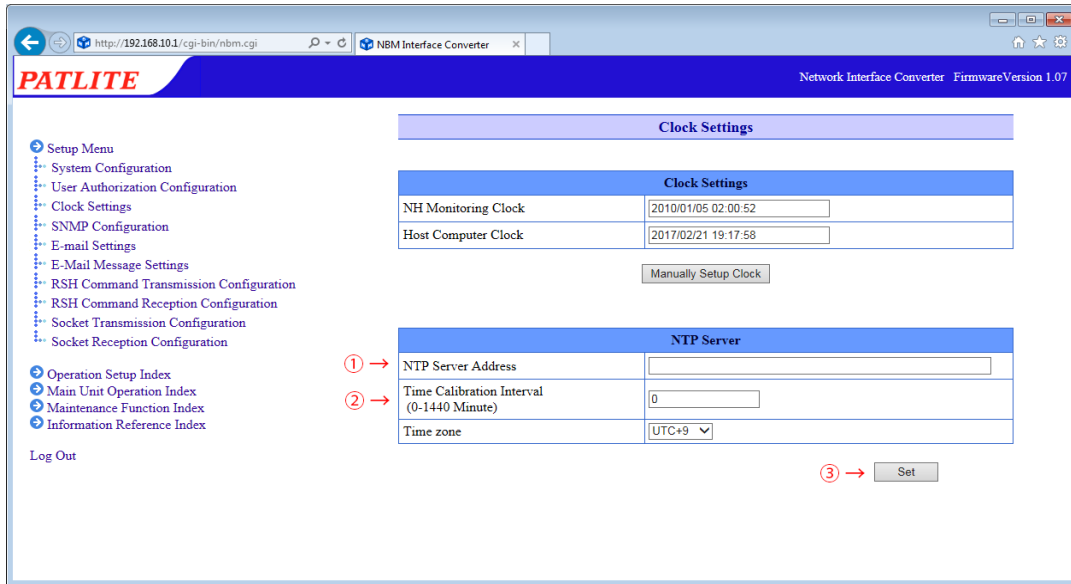

Fig. 4.3.2-1 Clock Setup screen for an NTP Server

### 4.3.3 Setting Time Zone

Determine the area to be used when setting the time zone.

**[Setup Method]**

- ① Select from the “Time zone” column and click to set.
- ② Click the “Set” button to activate the setup.

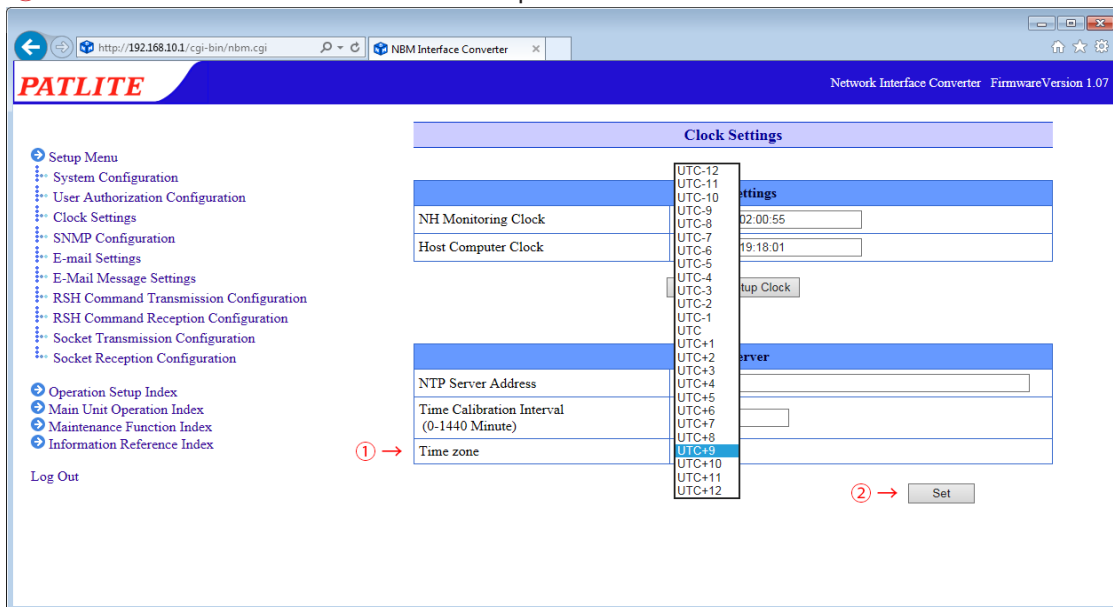

Fig. 4.3.3-1 Time zone setting screen

## 4.4 SNMP Configuration Screen

With an SNMP, this product can communicate outside the community name for the notification of a TRAP, using the SNMP SET/GET in reference to each item for this product, and generate the event with this product. The items in Table 4.4.3–1 can be set up for the SNMP Setup Screen.

### 4.4.1 SNMP SET/GET

An SNMP SET/GET can be setup.

#### [Setup Method]

- ① Select the “Active” radio button to enable the SNMP Function.
- ② Enter the SET/GET Community name.

### 4.4.2 SNMP Trap Reception

The SNMP trap reception can be set up.

#### [Setup Method]

- ③ Enter the Trap Reception Community name.

### 4.4.3 SNMP Trap Transmission

The SNMP trap transmission can be set up.

#### [Setup Method]

- ④ Set the Trap Transmission Function to “Active”, to enable it.
- ⑤ Enter the TRAP transmission community name and Number of TRAP Transmissions (1-10).
- ⑥ Enter in the TRAP Receiver Address field, the IP address for sending the TRAP notification to.
- ⑦ Click the “Set” button to activate the setup.

The screenshot shows the 'SNMP Configuration' screen with the following sections and fields:

- Community Name:**
  - SNMP Function (SET/GET):  Active  Inactive
  - SET Community:
  - GET Community:
- Trap Reception:**
  - Trap Reception Community:
- Trap Transmission:**
  - Trap Transmission Function:  Active  Inactive
  - Trap Transmission Community:
  - Number of Trap Transmissions (1-10 Time):
- Trap Receiver Address:**

1	<input type="text"/>
2	<input type="text"/>
3	<input type="text"/>
4	<input type="text"/>
5	<input type="text"/>
6	<input type="text"/>
7	<input type="text"/>
8	<input type="text"/>

A 'Set' button is located at the bottom right of the configuration area.

Fig. 4.4.3–1 SNMP Configuration screen

Table 4.4.3-1 SNMP Configuration Parameters

Item	Contents	Default Value	Input Parameter	Setup Option
SNMP Function (SET/GET)	Select "Active" or "Inactive" for the SNMP function.	Active	—	—
SET Community	Enter the name used when reading an SNMP setting.	private	Half-width alphanumeric character and underscore: Max. 32 Characters	—
GET Community	Enter the community name of the trap to be received.	public	Half-width alphanumeric character and underscore: Max. 32 Characters	—
TRAP Reception Community	Enter the community name of the Trap to be received.	public	Half-width alphanumeric character and underscore: Max. 32 Characters	—
Trap Transmission Function	Select "Active" or "Inactive" for the Trap transmission function.	Inactive	—	—
Trap transmission community	Enter the community name of the trap to be sent.	public	Half-width alphanumeric character and underscore: Max. 32 Characters	—
Number of Trap Transmissions	When sending a trap, enter how many times to send the same trap.	1	1 Half-width Digit from 1-10 (frequency)	—
Trap Receiver Address	Enter the address to send the trap.	Blank	IP address format. Characters which can be used for host names (Max. 63 Characters)	0

## 4.5 E-mail Settings Screen

This product can be set up to send E-mail messages. The following are events which will transmit E-mail messages.

When transmitting an E-mail, it is transmitted in sequence from the smaller address number to the larger address number of the Receiver. The items to be set up on the e-mail contents setting screen are shown in Table 4.5.0-1.

### << E-mail Transmitting Event >>

The digital input at a status change

When receiving a trap

At the time of a Ping monitoring abnormality and Ping recovery event.

At the time of an application monitoring abnormality and recovery event.

At the time when the "CLEAR" button is pressed.

When the digital input condition agrees

### [Setup Method]

- ① Enter an SMTP mail server address and port number.
- ② Enter the account name and SMTP authentication password when using the SMTP authentication. When making an encryption connection, select either "SSL" or "TLS". When using POP authentication, enter the POP server address, POP port number, POP account name, and POP authentication password. "No Authentication" is selected when authentication is not necessary.
- ③ Enter the e-mail address for the designated sender.
- ④ Enter the transmission destination address.
- ⑤ Click the "Set" button to activate the setup.

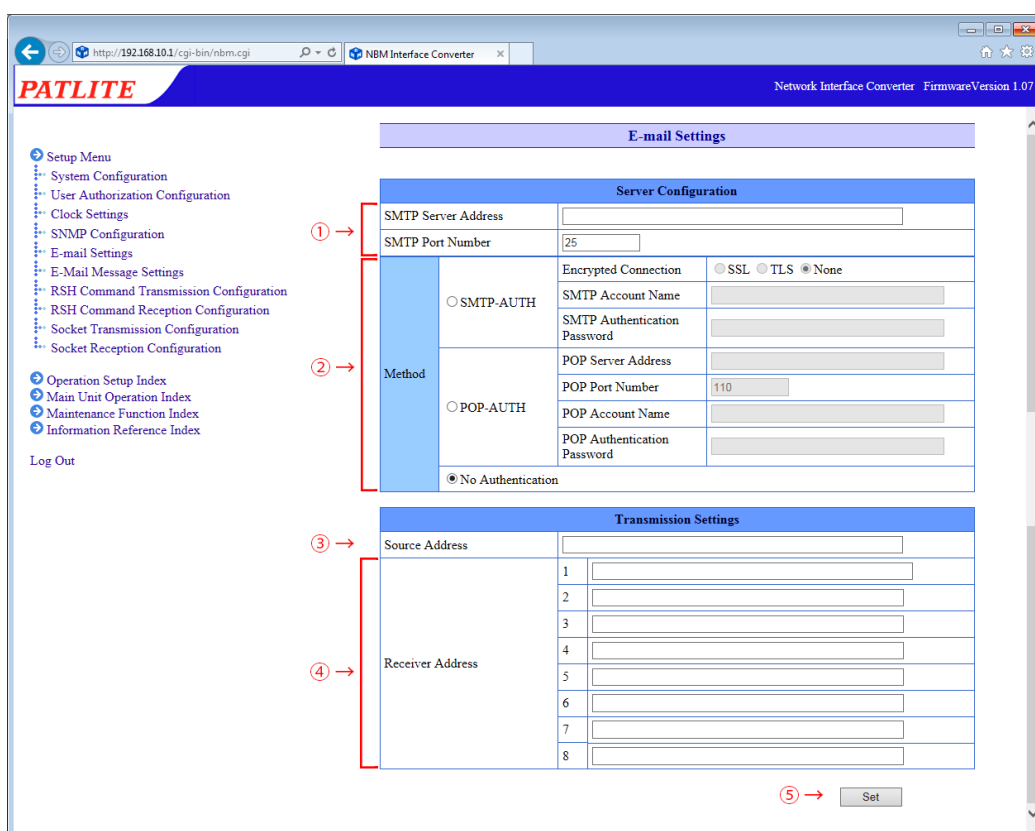

Fig. 4.5.0-1 E-mail Settings Screen

Table 4.5.0-1 E-mail Settings Protocol

Item	Contents	Default Value	Input Parameter	Setup Option
SMTP Server Address	Enter the SMTP server address.	Blank	Use characters for the server address; Max. 63 Characters	—
SMTP Port Number	Enter the SMTP server port number.	25	Half-width digit 1 - 65535	—
Method	Select among: "SMTP-AUTH"/"POP-AUTH"/"No Authentication"	No Authentication	—	—
Encrypted Connection	Select among "SSL"/"TLS"/"None"	None	—	—
SMTP Account Name	Enter the account name for the SMTP authentication.	Blank	Characters which can be used for e-mail addresses; Max. 32 Characters	—
SMTP Authentication Password	Enter the password for SMTP authentication.	Blank	Half-width alphanumeric characters; Maximum 32 Characters	—
POP3 Server Address	Enter the POP3 server address.	Blank	Characters which can be used for a server address; Max. 63 Characters	—
POP3 port number	Enter the port number for the POP3 server.	110	Half-width digits 1 - 65535	—
POP Account Name	Enter the account name for the POP authentication.	Blank	Half-width alphanumeric characters, characters which can be used for E-mail addresses; Max. 32 characters	—
POP Authentication Password	Enter the password for POP Authentication.	Blank	Half-width alphanumeric characters; Max. 32 Characters	—
Source Address	Enter the e-mail address for the designated sender.	Blank	Character which can be used for an E-mail address; Max. 63 characters	0
Receiver Address1-8	Enter the e-mail address for the Transmission destination addresses.	Blank	Character which can be used for an E-mail address; Max. 63 characters	0

## 4.6 E-Mail Message Settings Screen

The following is the setup of E-mail titles and message contents for E-mail Sending. When sending E-mails, the contents can be personalized to match the coinciding mail notifications by entering a title and message contents to transmit. The items to be set up on the e-mail contents setting screen are shown in Table 4.6.0-1.

### [Setup Method]

- ① Enter a title in the subject field to transmit by e-mail. (Full size or half-size alphanumeric characters up to 31 characters)
- ② Enter text to transmit for e-mail. (Full size or half-size alphanumeric characters up to 63 characters)
- ③ Click the "Set" button to activate the setup.

### Attention

When using full width characters for a subject, use JIS level-1 kanji (except for special characters). Characters may be lost if other characters are entered.

Fig. 4.6.0-1 E-Mail Message Settings Contents

Table 4.6.0-1 E-Mail Message Settings Parameters

Item	Contents	Default Value	Input Parameter	Setup Option
Subjects	Enter the subject titles 1-16.	Blank	Full or half size; Max. 31 Characters	O
Messages	Enter the texts 1-16.	Blank	Full or half size; Max. 31 Characters	O

## 4.7 RSH Command Transmission Configuration Screen

When an event occurs, it is set for the RSH command to be sent to another device. (Maximum: 8 events)

### [Setup Method]

- ① Enter the name of the command to be set.
- ② Enter the address of the command transmission destination.
- ③ Enter the login name to use when sending the command.
- ④ Enter the command.
- ⑤ Click the "Set" button to activate the setup.

The screenshot shows the 'RSH Command Transmission Configuration' screen. It features a table with 8 rows, each representing a configuration entry. The columns are 'No.', 'Name', 'Receiver Address', 'Login Name', and 'Command'. Red arrows and callouts indicate the following: ① points to the 'Name' field; ② points to the 'Receiver Address' field; ③ points to the 'Login Name' field; ④ points to the 'Command' field; and ⑤ points to the 'Set' button at the bottom right. A sidebar menu on the left lists various configuration options, with 'RSH Command Transmission Configuration' selected.

Fig. 4.7.0-1 RSH Command Transmission Configuration screen

Table 4.7.0-1 RSH Command Transmission Configuration Parameters

Item	Contents	Default Value	Input Parameter	Setup Option
Name	Enter the name of the command to be set.	Blank	Full or half-size; Max. 16 Characters	—
Receiver Address	Enter the address of the command transmission destination.	Blank	Characters which can be used for the IP address and host name; Max. 63 Characters	—
Login Name	Enter the account to use when sending the command.	Blank	Half-width alphanumeric characters, period, hyphen; Max. 63 Characters	—
Transmission command	Enter the command and arguments to be executed at the destination.	Blank	Full or half-size; Max. 255 Characters	—

## 4.8 RSH Command Reception Configuration Screen

Sets up the RSH command for receiving.

### [Setup Method]

- ① Select "Active" or "Inactive" for the "RSH Server Function."
- ② When performing the address restriction for the sender of the RSH command, set the "Designated Sender Address" to "Active". "Inactive" is used when address restrictions are not set.
- ③ When "Designated Sender Address" is set to "Inactive", enter the common account when the sender address is invalid.
- ④ In the designated sender IP address field, enter the IP address that allows command execution. (Maximum: 16 events) Enter the account which permits a command execution account.
- ⑤ Click the "Set" button to activate the setup.

Fig. 4.8.0-1 RSH Command Reception Configuration Screen

Table 4.8.3-1 RSH Command Reception Configuration Parameters

Item	Contents	Default Value	Input Parameter	Setup Option
RSH Server Function	Select among "effective"/"Inactive" for the "RSH Server Function"	Active	—	—
Designated Sender Address	Select between "Active"/"Inactive" for command designated sender address restrictions.	Active	—	—
Common login name when designated sender address is inactive	Enter the account to be used when disabling the designated sender address specification.	Blank	Half-width alphanumeric characters, period, hyphen: Max. 63 Characters	O
Sender IP Address	Enter the authorized IP address for command execution.	Blank	IP Address Format	O
Login Name	Enter the account to permit command execution.	Blank	Half-width alphanumeric characters, period, hyphen: Max. 63 Characters	O

## 4.9 Socket Transmission Configuration Screen

Configure settings for sending commands via Socket Communication.

Table 4.9.0-1 shows the items to be set on the socket transmission setting screen.

### [Setup Method]

- ① Enter the name of the command to be set.
- ② Enter the address of the command transmission destination.
- ③ Select a communication method between "TCP" or "UDP"
- ④ Enter the destination port number (5001-65535).
- ⑤ Enter the command to be sent.

Commands are entered in hexadecimal notation with each byte separated by commas.

- ⑥ Click the "Set" button to activate the setup.

Fig. 4.9.0-1 Socket Transmission Configuration screen

Table 4.9.0-1 Socket Transmission Configuration parameters

Item	Contents	Default Value	Input Parameter	Setup Option
Name	Enter the name of the command to be set.	Blank	Full or half size; Max. 16 Characters	—
Receiver Address	Enter the address of the command transmission destination.	Blank	Characters which can be used for the IP address and host name; Max. 63 Characters	—
Protocol	Select between "TCP" or "UDP"	TCP	—	—
Port Number	Enter the destination port number.	0	Half-width digit: 5001-65535	—
Transmission command	Enter the command to be sent. Enter with hexadecimal notation (comma separated values).	Blank	Half-width digit and comma; Max. 90 Characters, 30 bytes with one comma separating values and counting as 1 byte.	—



## 4.10 Socket Reception Configuration Screen

It uses Socket Communication to make settings for receiving PHN and PNS commands. The items to be set on the Socket reception setting screen are shown in Table 4.10.0-1.

### [Setup Method]

- ① Select either "TCP" or "UDP" in the "protocol" field for the communication method.
- ② Enter the port number (10000-65535) to be used.
- ③ Click the "Set" button to activate the setup.

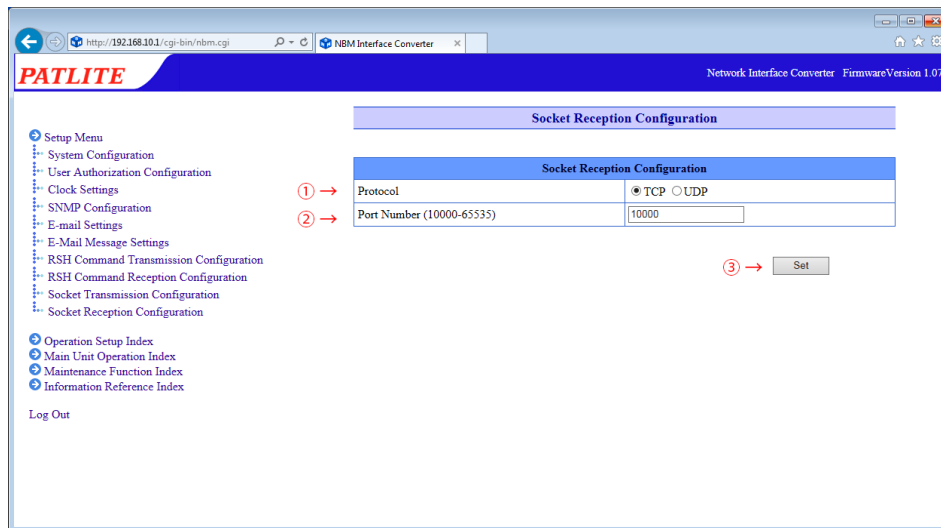

Fig. 4.10.0-1 Socket Reception Configuration screen

Table 4.10.0-1 Socket Reception Configuration parameters

Item	Contents	Default Value	Input Parameter	Setup Option
Protocol	Select between "TCP" or "UDP."	TCP	—	—
Port Number	Enter the receiving port number.	10000	Half-width digits 10000-65535	—

#### MEMO

- For the PHN Command, refer to "3.4 PHN Command Reception Function."
- For the PNS Command, refer to "3.5 PNS Command Reception Function."

## 4.11 Digital Input Setup Screen

It sets the operation when the digital input status changes. Refer to Table 4.11.0-1 for the items set up in the Digital Input Setup Screen.

### [Setup Method]

- ① Select the input port number (1 to 8) to be set.
- ② To enable the setting, select "Active."
- ③ Select the logical value (Contact A / Contact B) for the input port.
- ④ Select the Trigger Signal from "ON Status", "OFF status" and "Status Change."
- ⑤ Set up the operation for when there is a signal present.
- ⑥ Select the E-mail Sending Setup for when a signal is present. If the E-mail Sending is made "Active", the "E-mail Receiver" is selected for "Subject" and "Message" after activation.
- ⑦ To send a trap, select "Active."

### <<The "TRAP Command" for this product to receive when the TRAP condition occurs>>

When the digital input is turned "ON":

OID: 1.3.6.1.4.1.20440.4.4.1.1.1.1 - 1.3.6.1.4.1.20440.4.4.1.1.1.8

Name: diStateChangeON1 - diStateChangeON8

When the digital input is turned "OFF":

OID: 1.3.6.1.4.1.20440.4.4.1.1.2.1 - 1.3.6.1.4.1.20440.4.4.1.1.2.8

Name: diStateChangeOFF1 - diStateChangeOFF8

- ⑧ Click the "Set" button to activate the setup.

### MEMO

When the signal definition is set to "OFF Status", the "ON Status Change for Operation Setting 1" is displayed as "OFF Status Change for Operation Setting 1."

### << Signal definition screen display when selecting "ON Status" and "OFF Status" >>

The screenshot shows the "Digital Input Setup" screen. At the top, there are buttons for input ports 1 through 8, with port 1 highlighted. Below this is the "Digital Input 1" configuration section with the following fields:

- Active/Inactive:  Active  Inactive
- Logic Value:  Contact A  Contact B
- Trigger Signal: ON Status (dropdown menu)

Below this is the "ON Status Change Operation Setup 1" section, which includes a table for Digital Output settings:

Digital Output	1. Digital Output 1	No Change
	2. Digital Output 2	No Change
	3. Digital Output 3	No Change
	4. Digital Output 4	No Change
	5. Digital Output 5	No Change
	6. Digital Output 6	No Change
	7. Digital Output 7	No Change
	8. Digital Output 8	No Change

Other sections include RSH Command Transmission, Socket Transmission, E-mail Transmission (Active/Inactive, Subject, Message), E-mail Receiver, and Trap Transmission (Active/Inactive). A "Set" button is located at the bottom right.

Fig. 4.11.0-1 Digital Input Setup Screen (when "ON Status" is selected)

<< Signal definition screen display when selecting "Status Change" >>

When the "Status Change" is selected for the signal definition, the setup parameters in the Setup Screen are described in Table 4.11.0–12.

The operation setting input column is displayed for both the "at time of ON Status change", and the "at time of OFF Status change."



Fig. 4.11.0–2 Digital Input Setup Screen (when "Status Change" is selected)

Table 4.11.0–1 Digital Input Setup Parameters

Item	Contents	Default Value	Input Parameter	Setup Option
Active/Inactive	Select "Active" or "Inactive" for the digital input function.	Active	—	—
Logic Value	Select a logical value between "Contact A" - "Contact B."	Contact A	—	—
Trigger Signal	Select from "ON Status", "OFF Status", "Status Change" for signal definition.	ON Status	—	—
Digital Outputs 1-8	Select from "ON", "OFF", "No Change" for each port.	No Change	—	—
RSH Command Transmission 1-8	Select the transmission destination of the RSH command.	Unassigned	—	—
Socket transmission 1-16	Select the destination of the registered command.	Unassigned	—	—
E-mail Transmission	Select E-mail Sending as "Active" or "Inactive."	Inactive	—	—
Subject	Select the E-mail title	1.	—	—
Message	Select the E-mail text	1:	—	—
E-mail Receiver	Select the recipient to send E-mail to.	Unassigned	—	—
Trap Transmission	Select "Active" or "Inactive" for sending traps.	Inactive	—	—

## 4.12 Digital Output Setup Screen

Set the output for the digital output port.

Table 4.12.0-1 shows the items to be set on the digital output setting screen.

### [Setup Method]

- ① Enter the name of each port (1 to 8).
- ② Select "Active" or "Inactive" for each port.
- ③ Select the logical value (Contact A / Contact B) for the output port.
- ④ Enter the number of seconds (0 to 600) of the "Automatic OFF" function.  
When a "0" is entered, the "Automatic OFF" function is inactive.
- ⑤ To send a trap, select "Active."

<< The "TRAP Command" for this product to receive when the TRAP condition occurs >>

When the digital output is turned "ON":

OID: 1.3.6.1.4.1.20440.4.4.1.1.3.1 - 1.3.6.1.4.1.20440.4.4.1.1.3.8

Name: doStateChangeON1 - doStateChangeON8

When the digital output is turned "OFF":

OID: 1.3.6.1.4.1.20440.4.4.1.1.4.1 - 1.3.6.1.4.1.20440.4.4.1.1.4.8

Name: doStateChangeOFF1 - doStateChangeOFF8

- ⑥ Click the "Set" button to activate the setup.

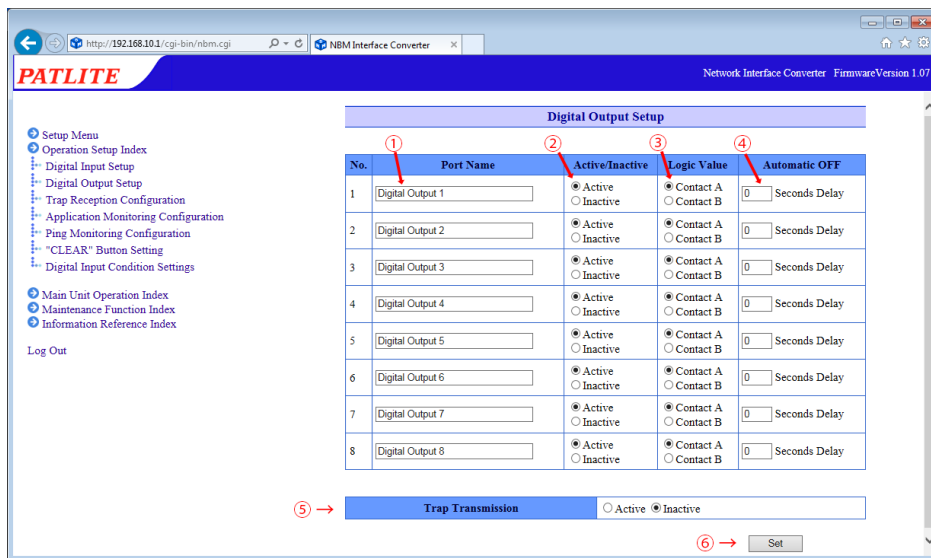

Fig. 4.12.0-1 Digital Output setting screen

Table 4.12.0-1 Digital Output Setup Parameters

Item	Contents	Default Value	Input Parameter	Setup Option
Port Name	Enter the name of the digital output port.	Digital output 1 - 8	Full and half-width size:Max. 16 Characters	0
Active/Inactive	Select "Active" or "Inactive" for the digital output function.	Active	—	—
Logic Value	Select a logical value between "Contact A" - "Contact B."	Contact A	—	—
Automatic OFF	Enter the time for the automatic OFF function.	0	Half-width digit 0-600 (Seconds)	0
Trap Transmission	Select "Active" or "Inactive" for sending traps.	Inactive	—	—

**MEMO** The Port Name is set to the initial value of the selected language at initialization.

### Attention

- When the digital output port is set as "Inactive", it cannot be operated from each function, including a post-setup status.
- Maintains the status of the port when it is set to "Inactive."

## 4.13 Trap Reception Configuration Screen

The traps can be set to allow trap operation and trap reception after being received.

Table 4.13.0-1 shows the items to set on the trap reception setting screen.

### [Setup Method]

- ① Select a reception setting number (1-16).
- ② Enter a group name.
- ③ Enter a trap designated sender address. \*
- ④ Enter the OID in the "Trap OID" field for the trap to be received. \*
- ⑤ Enter the OID in the "variable-bindings" field. \*
- ⑥ Set up the operation of this product when a trap is received.
- ⑦ Select the E-mail Sending configuration when receiving a TRAP. If the E-mail Sending is made "Active", the "E-mail Receiver" is selected for "subject" and "message" after activation.
- ⑧ To send a trap, select "Active."

<<The "TRAP Command" for this product to receive when the TRAP condition occurs>>

OID「1.3.6.1.4.1.20440.4.4.1.1.11.1 ~ 1.3.6.1.4.1.20440.4.4.1.1.11.16」

Name: snmpTrapReceived1 - snmpTrapReceived16

- ⑨ Click the "Set" button to activate the setup.

\* Refer to the following "MEMO" and "Attention" below:

#### MEMO

- When the trap transmission source address is entered, the "trap number" column and the "variable bindings" column can be omitted. When the TRAP "number column" and "variable bindings" columns are omitted, then all operations will be received by the TRAP transmission address which was setup for the TRAP transmission source address.
- When a TRAP transmission source address name is omitted, the operation is determined by the TRAP number.
- For two "variable bindings", the 1st registration can be used among the existing registered items.
- If both the "trap transmission source address" and "trap number" are omitted, even with "variable bindings" registered, it won't operate.
- When the "GenericTrap type" TRAP Reception is 6 (enterprisespecific), add the value "0. (specific-trap value)" to the last part of the specific-trap for the TRAP Reception.
- If the type of variable-bindings is specified as an integer, enter the value in half-width numbers. If the model is specified as a string, register the value in half-width characters.

#### Attention

- When the TRAP transmission source address name is omitted, the TRAP number cannot be omitted. If both the "trap transmission source address" and "trap number" are omitted, no operation after a reception will work.
- When a TRAP number has been duplicated and is registered into the group, the least significant setup number in the group is used. The following group number after that number is not used.
- Judgement can be made by the reception function with the number of variable-bindings as 64 with one per trap. To receive more than 65 variable bindings, the traps 1-64 must first be set to operate in the OID at the time of reception. Be aware that the OID after the 65th piece does not operate, even after it is set.

Network Interface Converter Firmware Version 1.07

### Trap Reception Configuration

1 → [ 1 | 2 | 3 | 4 | 5 | 6 | 7 | 8 | 9 | 10 | 11 | 12 | 13 | 14 | 15 | 16 ]

#### TRAP Reception Configuration Group 1

2 → Group Name1:

3 → Trap Source Address:

4 → Trap OID:

5 →

1	variable bindings 1	OID: <input type="text"/>	Type: integer	Value: <input type="text"/>
	variable bindings 2	OID: <input type="text"/>	Type: integer	Value: <input type="text"/>
	Trap Source Address	<input type="text"/>		
	Trap OID	<input type="text"/>		
2	variable bindings 1	OID: <input type="text"/>	Type: integer	Value: <input type="text"/>
	variable bindings 2	OID: <input type="text"/>	Type: integer	Value: <input type="text"/>
	Trap Source Address	<input type="text"/>		
	Trap OID	<input type="text"/>		
3	variable bindings 1	OID: <input type="text"/>	Type: integer	Value: <input type="text"/>
	variable bindings 2	OID: <input type="text"/>	Type: integer	Value: <input type="text"/>
	Trap Source Address	<input type="text"/>		
	Trap OID	<input type="text"/>		
4	variable bindings 1	OID: <input type="text"/>	Type: integer	Value: <input type="text"/>
	variable bindings 2	OID: <input type="text"/>	Type: integer	Value: <input type="text"/>

---

#### Trap Reception Operation Setting 1

6 →

Digital Output	1. Digital Output 1	No Change			
	2. Digital Output 2	No Change			
	3. Digital Output 3	No Change			
	4. Digital Output 4	No Change			
	5. Digital Output 5	No Change			
	6. Digital Output 6	No Change			
	7. Digital Output 7	No Change			
	8. Digital Output 8	No Change			
RSH Command Transmission	<input type="checkbox"/> 1 Unassigned	<input type="checkbox"/> 2 Unassigned	<input type="checkbox"/> 3 Unassigned	<input type="checkbox"/> 4 Unassigned	
	<input type="checkbox"/> 5 Unassigned	<input type="checkbox"/> 6 Unassigned	<input type="checkbox"/> 7 Unassigned	<input type="checkbox"/> 8 Unassigned	
Socket Transmission	<input type="checkbox"/> 1 Unassigned	<input type="checkbox"/> 2 Unassigned	<input type="checkbox"/> 3 Unassigned	<input type="checkbox"/> 4 Unassigned	
	<input type="checkbox"/> 5 Unassigned	<input type="checkbox"/> 6 Unassigned	<input type="checkbox"/> 7 Unassigned	<input type="checkbox"/> 8 Unassigned	
	<input type="checkbox"/> 9 Unassigned	<input type="checkbox"/> 10 Unassigned	<input type="checkbox"/> 11 Unassigned	<input type="checkbox"/> 12 Unassigned	
	<input type="checkbox"/> 13 Unassigned	<input type="checkbox"/> 14 Unassigned	<input type="checkbox"/> 15 Unassigned	<input type="checkbox"/> 16 Unassigned	
E-mail Transmission	<input type="radio"/> Active <input checked="" type="radio"/> Inactive Subject [ 1 ] Message [ 1 ]				
E-mail Receiver	<input type="checkbox"/> 1 Unassigned	<input type="checkbox"/> 2 Unassigned	<input type="checkbox"/> 3 Unassigned	<input type="checkbox"/> 4 Unassigned	
	<input type="checkbox"/> 5 Unassigned	<input type="checkbox"/> 6 Unassigned	<input type="checkbox"/> 7 Unassigned	<input type="checkbox"/> 8 Unassigned	
Trap Transmission	<input type="radio"/> Active <input checked="" type="radio"/> Inactive				

7 →

8 →

9 →

Fig. 4.13.0-1 Trap Reception Configuration screen

Table 4.13.0-1 Trap Reception Configuration parameters

Item	Contents	Default Value	Input Parameter	Setup Option
Group Name	Enter the group's name.	Blank	Full or half-size; Max. 32 Characters	0
Trap Source Address	Enter the source address of the trap to receive. (1-4 events)	Blank	IP Address Format	0
Trap OID	Enter the OID of the trap to receive. (1-4 events)	Blank	Number and period; Max. 127 Characters	0
OID (variable-bindings)	Enter the OID into the column of the variable-bindings being received. (1-4 events)	Blank	Number and period; Max. 127 Characters	0
Type (variable-bindings)	Select the type of variable-bindings OID to receive from "integer" or "string". (1-4 events)	integer	—	—
Value (variable-bindings)	Enter the value into the column of the variable-bindings being received. (1-4 events)	Blank	Numbers (0 to 65535) or Full/half-width characters; Maximum 63 Characters Full-width characters are extended functions, so they will not work even if they are registered.	0
Digital Outputs 1-8	For each port, select "ON", "OFF", "No Change".	No Change	—	—
RSH Command Transmission 1-8	Select the transmission destination of the RSH command.	Unassigned	—	—
Socket transmission 1-16	Select the destination of the registered command.	Unassigned	—	—
E-mail Transmission	Select E-mail Sending as "Active" or "Inactive."	Inactive	—	—
Subject	Select the E-mail title.	1.	—	—
Message	Select the E-mail text.	1:	—	—
E-mail Receiver	Select the recipient to send E-mail to.	Unassigned	—	—
Trap Transmission	Select "Active" or "Inactive" for sending traps.	Inactive	—	—

## 4.14 Application Monitoring Configuration Screen

Setup for monitoring an application. The data reception of the target is monitored.

If data is not received within the Ping test cycle period, it detects a monitor abnormality, and generates an abnormality event. After a generated event, if data is received from the monitored candidate, it will detect a recovery from the abnormal operation.

### [Setup Method]

- ① Select a number between 1 and 4 for four different application monitor Setups.
- ② Enter the IP address for a target to monitor. (When an abbreviation or 0 is entered, the monitoring function becomes inactive)
- ③ Enter the Receiving Port Number (0, or 9000-9999).
- ④ Enter a device name.
- ⑤ Enter the number of seconds for a monitoring interval (0-60000).

### << Operation Setting for Monitoring Abnormality >>

- ⑥ Set the operation up for this product when monitor abnormality occurs.
- ⑦ Select from the E-mail Sending Setup when monitor abnormality occurs.  
If the E-mail Sending is made "Active", the "E-mail Receiver" is selected for "subject" and "message" after activation.
- ⑧ To send a trap, select "Active."

### << The "TRAP Command" for this product to receive when the TRAP condition occurs >>

OID: 1.3.6.1.4.1.20440.4.4.1.1.8.1 - 1.3.6.1.4.1.20440.4.4.1.1.8.4

Name: appError1 - appError4

The screenshot displays the 'Application Monitoring Configuration' interface. At the top, there are navigation tabs labeled 1, 2, 3, and 4. Below this is the 'Monitoring Target Application 1' section with the following fields:

Monitoring Target Address	<input type="text"/>
Reception Port Number (9000-9999)	<input type="text" value="0"/>
Equipment Name	<input type="text"/>
Monitoring Interval (0-60000 Seconds)	<input type="text" value="0"/>

Below this is the 'Output Control Setting for Application Monitoring Error 1' section, which includes:

Digital Output	1. Digital Output 1	<input type="text" value="No Change"/>			
	2. Digital Output 2	<input type="text" value="No Change"/>			
	3. Digital Output 3	<input type="text" value="No Change"/>			
	4. Digital Output 4	<input type="text" value="No Change"/>			
	5. Digital Output 5	<input type="text" value="No Change"/>			
	6. Digital Output 6	<input type="text" value="No Change"/>			
	7. Digital Output 7	<input type="text" value="No Change"/>			
	8. Digital Output 8	<input type="text" value="No Change"/>			
RSH Command Transmission	<input type="checkbox"/> 1 Unassigned	<input type="checkbox"/> 2 Unassigned	<input type="checkbox"/> 3 Unassigned	<input type="checkbox"/> 4 Unassigned	
	<input type="checkbox"/> 5 Unassigned	<input type="checkbox"/> 6 Unassigned	<input type="checkbox"/> 7 Unassigned	<input type="checkbox"/> 8 Unassigned	
Socket Transmission	<input type="checkbox"/> 1 Unassigned	<input type="checkbox"/> 2 Unassigned	<input type="checkbox"/> 3 Unassigned	<input type="checkbox"/> 4 Unassigned	
	<input type="checkbox"/> 5 Unassigned	<input type="checkbox"/> 6 Unassigned	<input type="checkbox"/> 7 Unassigned	<input type="checkbox"/> 8 Unassigned	
	<input type="checkbox"/> 9 Unassigned	<input type="checkbox"/> 10 Unassigned	<input type="checkbox"/> 11 Unassigned	<input type="checkbox"/> 12 Unassigned	
	<input type="checkbox"/> 13 Unassigned	<input type="checkbox"/> 14 Unassigned	<input type="checkbox"/> 15 Unassigned	<input type="checkbox"/> 16 Unassigned	
E-mail Transmission	<input type="radio"/> Active <input checked="" type="radio"/> Inactive Subject [1] Message [1]				
E-mail Receiver	<input type="checkbox"/> 1 Unassigned	<input type="checkbox"/> 2 Unassigned	<input type="checkbox"/> 3 Unassigned	<input type="checkbox"/> 4 Unassigned	
	<input type="checkbox"/> 5 Unassigned	<input type="checkbox"/> 6 Unassigned	<input type="checkbox"/> 7 Unassigned	<input type="checkbox"/> 8 Unassigned	
Trap Transmission	<input type="radio"/> Active <input checked="" type="radio"/> Inactive				

Fig. 4.14.0-1 Application Monitoring Configuration Screen No. 1



<< Operation Setting for Recovering Monitoring Abnormality >>

- ⑨ Set up the operation setting for this product to recover from monitoring abnormality.
- ⑩ Select the E-mail Sending Setup when restoring from a monitor abnormality.  
If the E-mail Sending is made "Active", the "E-mail Receiver" is selected for "subject" and "message" after activation.
- ⑪ To send a trap, select "Active."

<< The "Active" Trap Command which this product transmits >>

OID: 1.3.6.1.4.1.20440.4.4.1.1.9.1 - 1.3.6.1.4.1.20440.4.4.1.1.9.4  
Name: appRecover1 - appRecover4

- ⑫ Click the "Set" button to activate the setup.

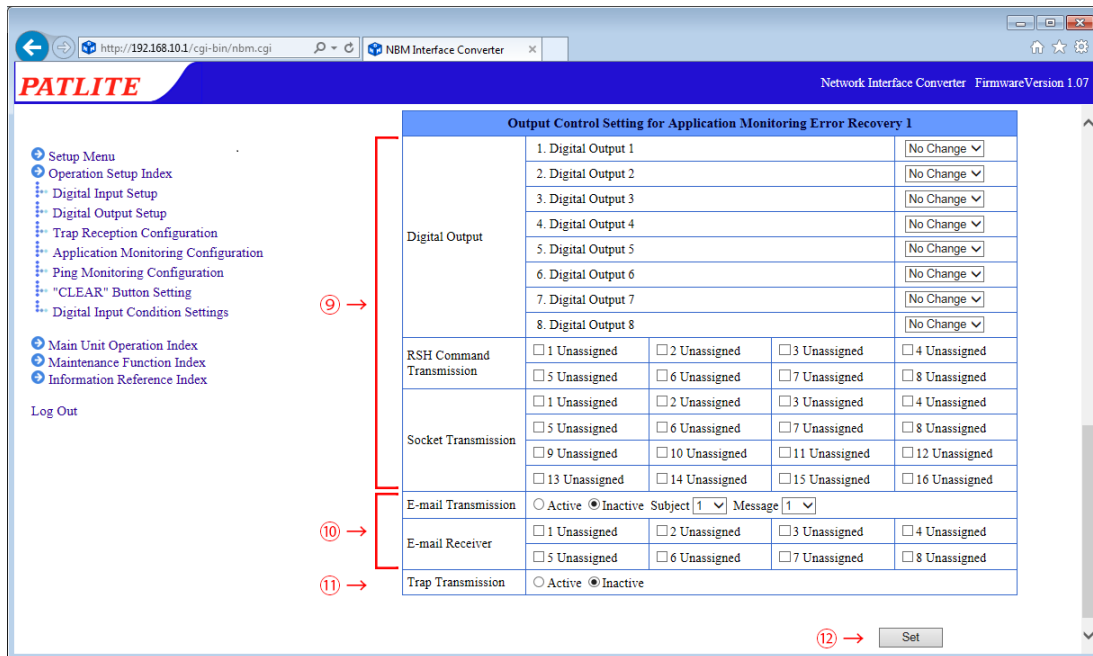

Fig. 4.14.0-2 Application Monitoring Configuration Screen No. 2

Table 4.14.0-1 Application Monitoring Configuration Parameters

Item	Contents	Default Value	Input Parameter	Setup Option
Monitoring Target Address	Enter the IP address for transmission monitoring.	Blank	IP Address Format	○
Reception Port Number	Enter the receiving port to be used for the application monitor.	0	Half-width digits 0, 9000-9999	—
Equipment Name	Enter the name for the Ping transmission monitoring.	Blank	Full or half size; Max. 32 Characters	○
Monitoring Interval	Set the interval for receiving data.	0	Full or half size 0: Monitor Disabled 1-60000 (Seconds)	○
Digital Outputs 1-8	For each port, select "ON", "OFF", "No Change".	No Change	—	—
RSH Command Transmission 1-8	Select the transmission destination of the RSH command.	Unassigned	—	—
Socket transmission 1-16	Select the destination of the registered command.	Unassigned	—	—
E-mail Transmission	Select E-mail Sending as "Active" or "Inactive."	Inactive	—	—
Subject	Select the E-mail title	1.	—	—
Message	Select the E-mail text	1:	—	—
E-mail Receiver	Select the recipient to send E-mail to.	Unassigned	—	—
Trap Transmission	Select "Active" or "Inactive" for sending traps.	Inactive	—	—

## 4.15 Ping Monitoring Configuration Screen

The Ping monitor can be set up.

When the Ping monitor detects an abnormality, as a result, it generates a monitor abnormality condition. After a monitor abnormality is generated, if there is a response from a Ping request, it will then determine a recovery from the abnormal condition, and will continue its normal operate after restoration.

A maximum number of 24 Ping monitors can be registered.

### [Setup Method]

- ① Select the screen setup numbers from No. 1-20, to setup the Ping monitoring parameters.
- ② Enter the IP address for a target to monitor.
- ③ Enter the device name for a target to monitor.
- ④ Enter a Cycle count Error threshold value (0-30).
- ⑤ Enter the number of seconds for a monitoring cycle (0-600).
- ⑥ Enter a number for Pings per test cycle (1-3).

### << Operation Setting for Monitoring Abnormality >>

- ⑦ Set the operation up for this product when monitor abnormality occurs.
- ⑧ Select from the E-mail Sending Setup when monitor abnormality occurs.  
If the E-mail Sending is made "Active", the "E-mail Receiver" is selected for "subject" and "message" after activation.
- ⑨ To send a trap, select "Active."

### << The "TRAP Command" for this product to receive when the TRAP condition occurs >>

OID: 1.3.6.1.4.1.20440.4.4.1.1.6.1 - 1.3.6.1.4.1.20440.4.4.1.1.6.24

Name: pingError1 - pingError24

**Ping Monitoring Configuration**

① → [1] 2 3 4 5 6 7 8 9 10 11 12  
13 14 15 16 17 18 19 20 21 22 23 24

② → Monitoring Targeted Equipment1

③ → Monitoring Targeted Equipment1

④ → Cycle count Error Threshold (0-30) [0] (Number of sequential ping test cycles with no ping response)

⑤ → Pings test cycle period (1-600 Seconds) [60] (Length of time for Ping Test Cycle)

⑥ → Ping Per Test Cycle (1-3) [1] (Number of pings sent in each Ping Test Cycle)

⑦ → Output Control Setting for Ping Monitoring Error 1

Digital Output	1. Digital Output 1	No Change		
	2. Digital Output 2	No Change		
	3. Digital Output 3	No Change		
	4. Digital Output 4	No Change		
	5. Digital Output 5	No Change		
	6. Digital Output 6	No Change		
	7. Digital Output 7	No Change		
	8. Digital Output 8	No Change		
RSH Command Transmission	<input type="checkbox"/> 1 Unassigned	<input type="checkbox"/> 2 Unassigned	<input type="checkbox"/> 3 Unassigned	<input type="checkbox"/> 4 Unassigned
	<input type="checkbox"/> 5 Unassigned	<input type="checkbox"/> 6 Unassigned	<input type="checkbox"/> 7 Unassigned	<input type="checkbox"/> 8 Unassigned
	<input type="checkbox"/> 9 Unassigned	<input type="checkbox"/> 10 Unassigned	<input type="checkbox"/> 11 Unassigned	<input type="checkbox"/> 12 Unassigned
	<input type="checkbox"/> 13 Unassigned	<input type="checkbox"/> 14 Unassigned	<input type="checkbox"/> 15 Unassigned	<input type="checkbox"/> 16 Unassigned
Socket Transmission	<input type="checkbox"/> 1 Unassigned	<input type="checkbox"/> 2 Unassigned	<input type="checkbox"/> 3 Unassigned	<input type="checkbox"/> 4 Unassigned
	<input type="checkbox"/> 5 Unassigned	<input type="checkbox"/> 6 Unassigned	<input type="checkbox"/> 7 Unassigned	<input type="checkbox"/> 8 Unassigned
	<input type="checkbox"/> 9 Unassigned	<input type="checkbox"/> 10 Unassigned	<input type="checkbox"/> 11 Unassigned	<input type="checkbox"/> 12 Unassigned
	<input type="checkbox"/> 13 Unassigned	<input type="checkbox"/> 14 Unassigned	<input type="checkbox"/> 15 Unassigned	<input type="checkbox"/> 16 Unassigned
E-mail Transmission	<input type="radio"/> Active <input checked="" type="radio"/> Inactive	Subject [1] Message [1]		
E-mail Receiver	<input type="checkbox"/> 1 Unassigned	<input type="checkbox"/> 2 Unassigned	<input type="checkbox"/> 3 Unassigned	<input type="checkbox"/> 4 Unassigned
	<input type="checkbox"/> 5 Unassigned	<input type="checkbox"/> 6 Unassigned	<input type="checkbox"/> 7 Unassigned	<input type="checkbox"/> 8 Unassigned
Trap Transmission	<input type="radio"/> Active <input checked="" type="radio"/> Inactive			

⑧ →

⑨ →

Fig. 4.15.0-1 Ping Monitoring Configuration Screen No. 1

<< Operation Setting for Recovering Monitoring Abnormality >>

- ⑩ Set up the operation setting for this product to recover from monitoring abnormality.
- ⑪ Use the E-mail Sending Setup when recovering from monitoring abnormality.  
If the E-mail Sending is made "Active", the "E-mail Receiver" is selected for "subject" and "message" after activation.
- ⑫ To send a trap, select "Active."

<< The "TRAP Command" for this product to receive when the TRAP condition occurs >>

OID: 1.3.6.1.4.1.20440.4.4.1.1.7.1 - 1.3.6.1.4.1.20440.4.4.1.1.7.24  
Name: pingRecover1 - pingRecover24

- ⑬ Click the "Set" button to activate the setup.

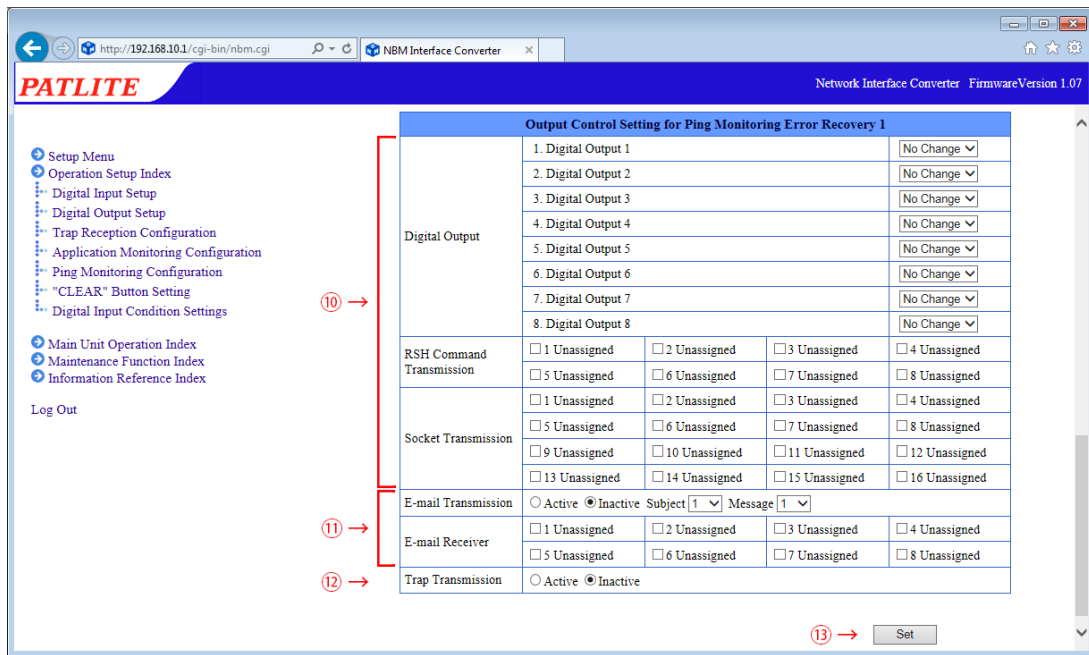

Fig. 4.15.0-2 Ping Monitoring Configuration Screen No. 2

Table 4.15.0-1 Ping Monitoring Configuration Parameters

Item	Contents	Default Value	Input Parameter	Setup Option
Monitoring Target Address	Enter the IP address or host name for the ping monitoring.	Blank	Characters which can be used for the IP address and host name: Max. 63 Characters	○
Equipment Name	Enter the name for the Ping transmission monitoring.	Blank	Full or half size: Max. 32 Characters	○
Cycle count Error Threshold	Enter the Ping response judgement value for determining Ping abnormality. It does not operate when set to 0.	0	Half-width digits 0-30 (cycles)	—
Pings test cycle period	Enter the period which transmits the Ping.	60	1-600 (Seconds)	—
Ping Per Test Cycle	Enter the number of Pings to transmit per period.	1	1-3 (per period)	—
Digital Output	For each port, select "ON", "OFF", "No Change".	No Change	—	—
RSH Command Transmission	Select the transmission destination of the RSH command.	Unassigned	—	—
Socket transmission	Select the destination of the registered command.	Unassigned	—	—
E-mail Transmission	Select E-mail Sending as "Active" or "Inactive."	Inactive	—	—
Subject	Select the E-mail title.	1.	—	—
Message	Select the E-mail text.	1:	—	—
E-mail Receiver	Select the recipient to send E-mail to.	Unassigned	—	—
Trap Transmission	Select "Active" or "Inactive" for sending traps.	Inactive	—	—

## 4.16 "Clear" Button Setting Screen

Set the operation to be performed when the "Clear" switch has been pressed.

### [Setup Method]

- ① Set the operation of this product when the "Clear" switch has been pressed.
- ② Select the E-mail Sending Setup for when the "Clear" switch has been pressed.  
If the E-mail Sending is made "Active", the "E-mail Receiver" is selected for "subject" and "message" after activation.
- ③ To send a trap, select "Active."

<< The trap this product sends when it is Active >>

OID: 1.3.6.1.4.1.20440.4.4.1.1.5.1

Name: clearSwitch

- ④ Click the "Set" button to activate the setup.

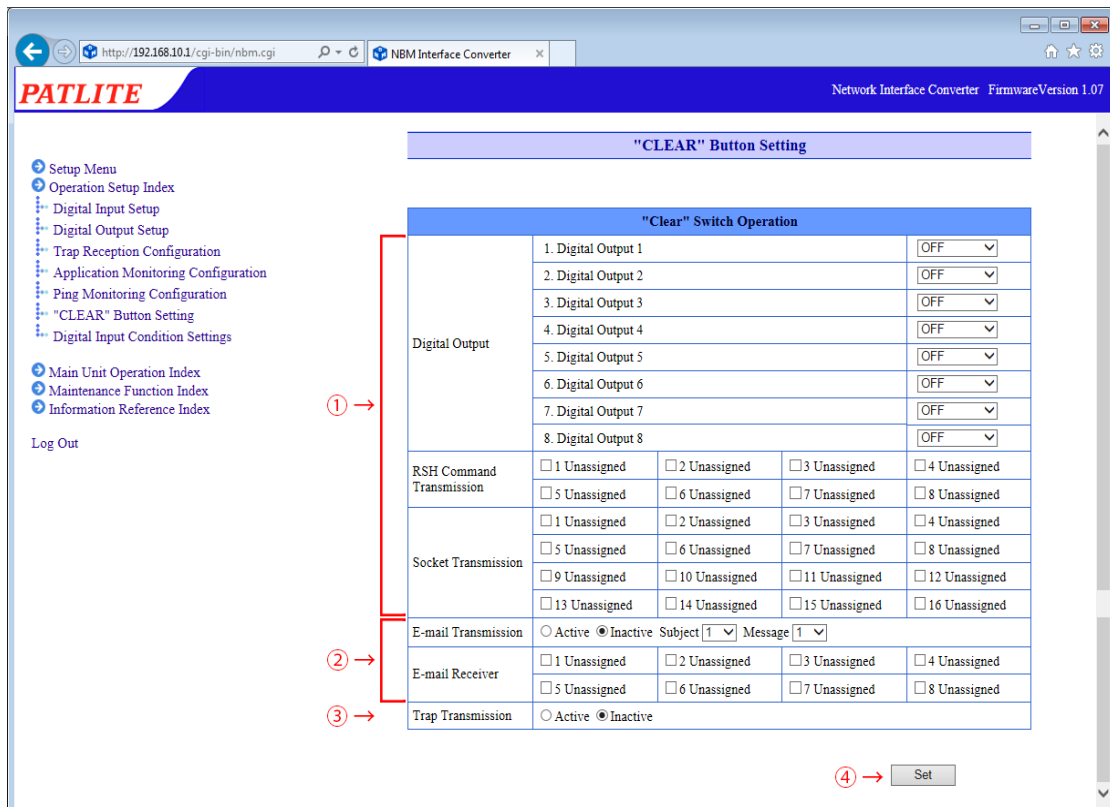

Fig. 4.16.0-1 "Clear" button setting screen

Table 4.16.0-1 "Clear" button setting parameters

Item	Contents	Default Value	Input Parameter	Setup Option
Digital Output	For each port, select "ON", "OFF", "No Change".	OFF	—	—
RSH Command Transmission	Select the transmission destination of the RSH command.	Unassigned	—	—
Socket transmission	Select the destination of the registered command.	Unassigned	—	—
E-mail Transmission	Select E-mail Sending as "Active" or "Inactive."	Inactive	—	—
Subject	Select the E-mail title	1.	—	—
Message	Select the E-mail text	1:	—	—
E-mail Receiver	Select the recipient to send E-mail to.	Unassigned	—	—
Trap Transmission	Select "Active" or "Inactive" for sending traps.	Inactive	—	—

## 4.17 Digital Input Condition Settings Screen

Set up the Digital Input conditions.

[Setup Method]

(The Setup Screen should show the following page)

<< When "AND detection" is selected >>

- ① Select a number (1-4) for the condition setup.
- ② Select the pattern to detect "AND detection".  
Select from the condition pull-down menu (digital inputs 1 to 8). Up to 4 ports can be set.
- ③ Set the operation when the conditions agree.
- ④ Select the mail transmission setting when the condition agrees.  
If the E-mail Sending is made "Active", the "E-mail Receiver" is selected for "subject" and "message" after activation.
- ⑤ To send a trap, select "Active."

<< The "TRAP Command" for this product to receive when the TRAP condition occurs >>

OID: 1.3.6.1.4.1.20440.4.4.1.1.10.1 - 1.3.6.1.4.1.20440.4.4.1.1.10.5

Name: diConditionMatch1 - diConditionMatch5

- ⑥ Click the "Set" button to activate the setup.

Fig. 4.17.0-1 Digital Input Condition Settings screen ("AND detection" pattern)

<< When "Number of detection times" is selected >>

- ① Select a number (1-5) for the condition setup.
- ② Select the detection pattern "Number of detection times".  
Select from the condition pull-down menu (digital inputs 1 to 8).  
Enter the measurement time and number of measurements.
- ③ Select the operation when pressing the clear switch from "Active" or "Inactive."
- ④ Select whether to detect the second or subsequent condition match with "Yes" or "No."
- ⑤ Set the operation when the conditions agree.
- ⑥ Select the mail transmission setting when the condition agrees.  
If the E-mail Sending is made "Active", the "E-mail Receiver" is selected for "subject" and "message" after activation.
- ⑦ To send a trap, select "Active."

<< The "TRAP Command" for this product to receive when the TRAP condition occurs >>

OID: 1.3.6.1.4.1.20440.4.4.1.1.10.1 - 1.3.6.1.4.1.20440.4.4.1.1.10.5

Name: diConditionMatch1 - diConditionMatch5

- ⑧ Click the "Set" button to activate the setup.

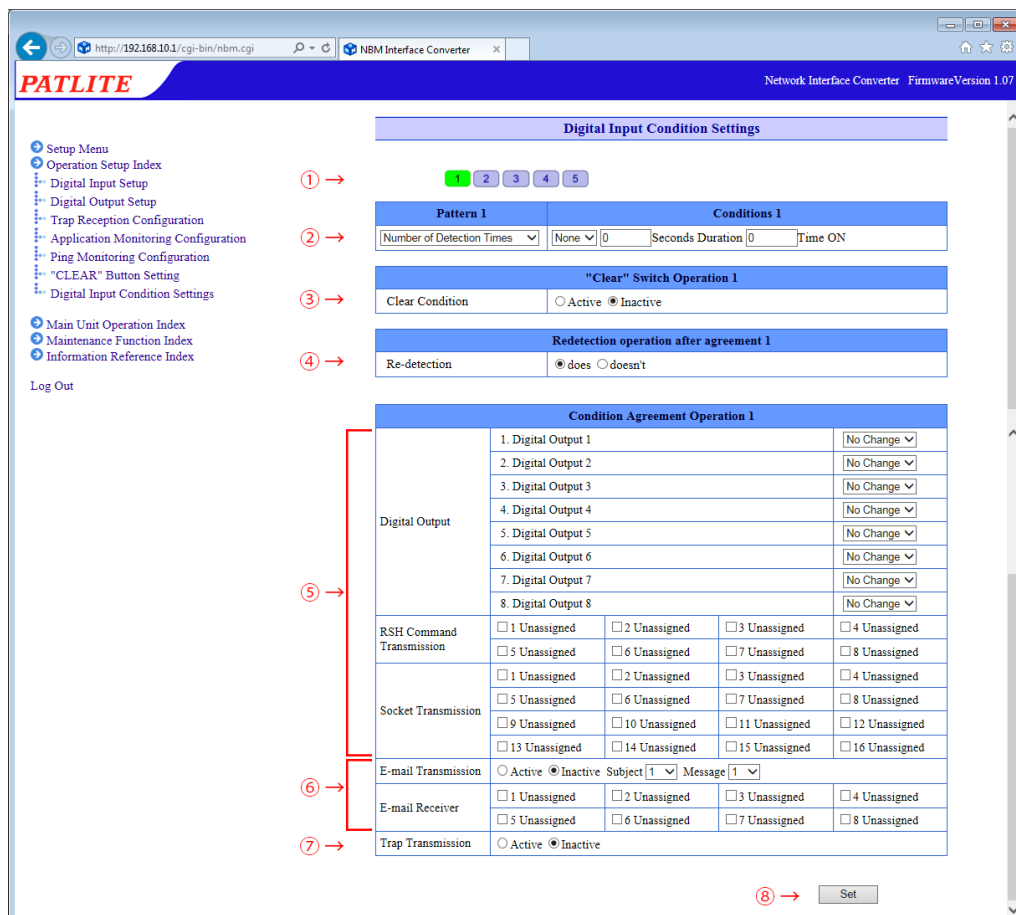

Fig. 4.17.0-2 Digital Input Condition Settings screen ("Number of Detection Times" pattern)

<< When “Continued Detection Duration” is selected >>

- ① Select a number (1-5) for the condition setup.
- ② Select the detection pattern “Time Continuation Detection”.  
Select from the condition pull-down menu (digital inputs 1 to 8).  
Enter the measurement time.
- ③ Select the operation when pressing the clear switch from “Active” or “Inactive.”
- ④ Select whether to detect the second or subsequent condition match with “Yes” or “No.”
- ⑤ Set the operation when the conditions agree.
- ⑥ Select the mail transmission setting when the condition agrees.  
If the E-mail Sending is made “Active”, the “E-mail Receiver” is selected for “subject” and “message” after activation.
- ⑦ To send a trap, select “Active.”

<< The “TRAP Command” for this product to receive when the TRAP condition occurs >>

OID: 1.3.6.1.4.1.20440.4.4.1.1.10.1 - 1.3.6.1.4.1.20440.4.4.1.1.10.5

Name: diConditionMatch1 - diConditionMatch5

- ⑧ Click the “Set” button to activate the setup.

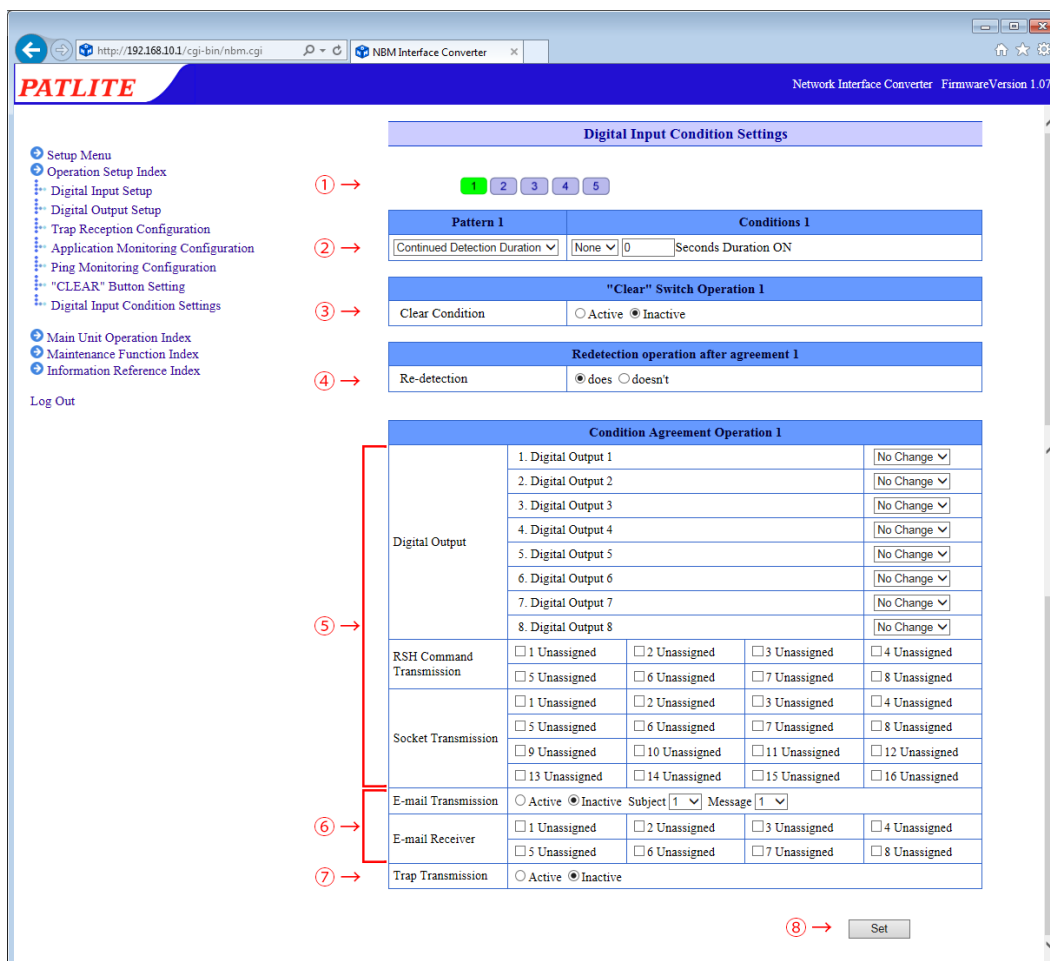

Fig. 4.17.0-3 Digital Input Condition Settings screen (“Continued Detection Duration” pattern)

Table 4.17.0-1 Digital Input Condition Settings Parameters

Item	Contents	Default Value	Input Parameter	Setup Option
Pattern	Select the pattern to be detected from "AND detection", "count detection", "Time Continuation Detection."	AND detection	—	—
Digital input detection	Select the digital input (ports 1-8) to detect from the pull down menu. It will not operate if "None" is selected.	None	—	—
When "Number of detection times" is Selected.				
Measured time	Enter the time to measure. It does not operate when set to 0. When it is set to 99999, the time setting becomes an unlimited status and will become a condition setting of only a predetermined number.	0	Half-width digits; 0-86400, or 99999	—
Measured frequency	Enter the number of times to measure. Depending on the value entered for "Number of seconds", the upper limit of the number of times that can be set, can only be changed to 4, 8, or 10.	0	Half-width digits; Measurement times: - 1 second: 0-4 - 2 seconds: 0-8 - 3 seconds or more: 0-10	—
Condition clear	Based on the "Clear" condition , a clear will occur when the "Clear" button is pressed. When set to "Active", an initialization will occur when the "Clear" button is pressed. When set to "Inactive", there is no change, even if the "Clear" button is pressed.	Inactive	—	—
Redetection	Re-detection can be set up. When set to "does", it detects when detection conditions agree and operates. When set to "doesn't", after the setup, it only operates when the detection condition agrees at the beginning, and even if it agrees after that, it does not operate.	does	—	—
When "Continued Detection Duration" is Selected.				
Number of seconds	Enter the time to measure. It does not operate when set to 0.	0	Half-width digits; 0-86400,	—
Condition clear	Based on the "Clear" condition , a clear will occur when the "Clear" button is pressed. When set to "Active", an initialization will occur when the "Clear" button is pressed. When set to "Inactive", there is no change, even if the "Clear" button is pressed.	Inactive	—	—
Redetection	Re-detection can be set up. When set to "does", it detects when detection conditions agree and operates. When set to "doesn't", after the setup, it only operates when the detection condition agrees at the beginning, and even if it agrees after that, it does not operate.	does	—	—
Digital Outputs	For each port, select "ON", "OFF", "No Change".	No Change	—	—
RSH Command Transmission	Select the transmission destination of the RSH command.	Unassigned	—	—
Socket transmission	Select the destination of the registered command.	Unassigned	—	—
E-mail Transmission	Select E-mail Sending as "Active" or "Inactive."	Inactive	—	—
Subject	Select the E-mail title.	1.	—	—
Message	Select the E-mail text.	1:	—	—
E-mail Receiver	Select the recipient to send E-mail to.	Unassigned	—	—
Trap Transmission	Select "Active" or "Inactive" for sending traps.	Inactive	—	—

4



## 4.18 Reinitialization Setup Screen

The setup parameters can be reset to their default values by initializing this product. The network setup can be selected to be excluded from initialization. If the “Network also reinitializes.” is checked, it reverts back to the factory default status. If it is not checked, initialization of the other settings, excluding the network settings, is executed.

MEMO

“Network setting” refers to the “main unit IP address, netmask, default gateway, DNS server address, host name, domain name” items on the system setting screen.

### [Setup Method]

#### << Network Initialization setting >>

- ① Put a check in the “Network also reinitializes.” box.
- ② Click the “Execute Reinitialization” button.

#### << When initializing only other settings without changing network settings >>

- ② Click the “Execute Reinitialization” button.

Attention

If the network setup is also initialized, since the IP address will return to its factory default value, the network has to be setup again.

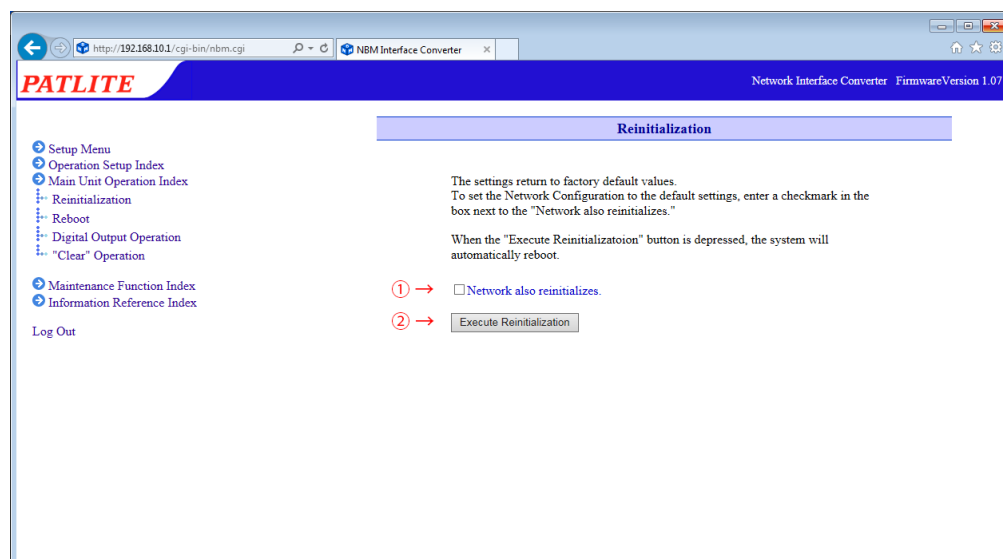

Fig. 4.18.0-1 Reinitialization screen

4

## 4.19 Reboot Screen

This product can be rebooted just by clicking the “Reboot” button.

- ① Once the “Reboot” button is clicked, a new screen will display a message indicating it is rebooting.
- ② Click “To the Login Screen” on the new screen to log back in. (Refer to Fig. 4.19.0-1)

MEMO

If a log is required, be sure to download the logs from the status log screen and operation log screen in advance.

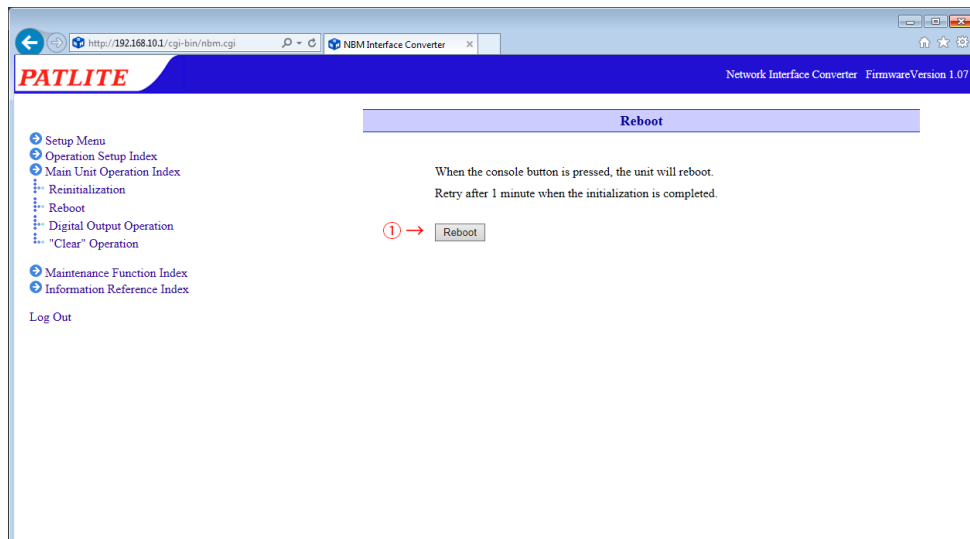

Fig. 4.19.0-1 Reboot screen 1

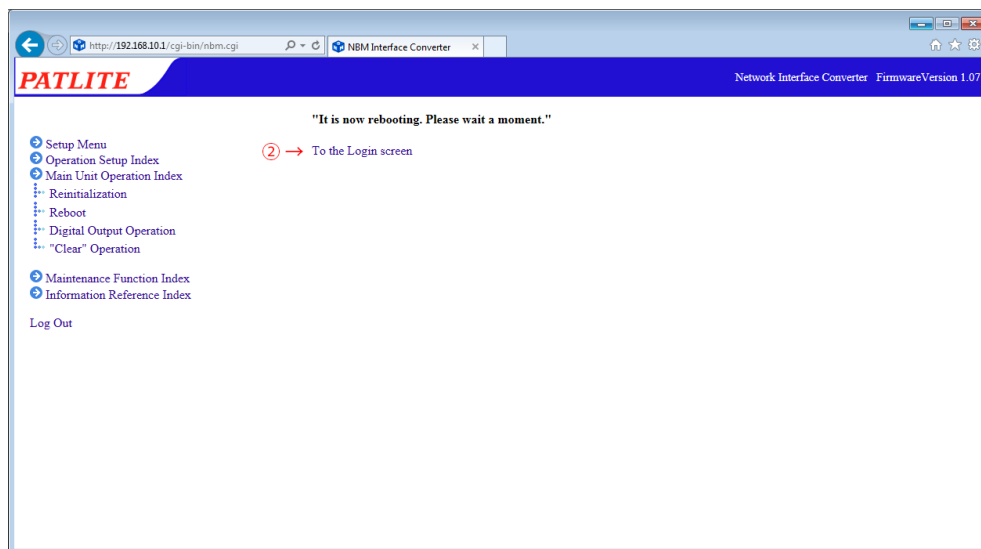

Fig. 4.19.0-2 Reboot screen 2

## 4.20 Digital Output Operation Screen

Configure the output operation of the digital output port.

### [Setup Method]

- ① Select the operation of each port among "ON", "OFF", "Not operating".
- ② Click the "Execute" button.

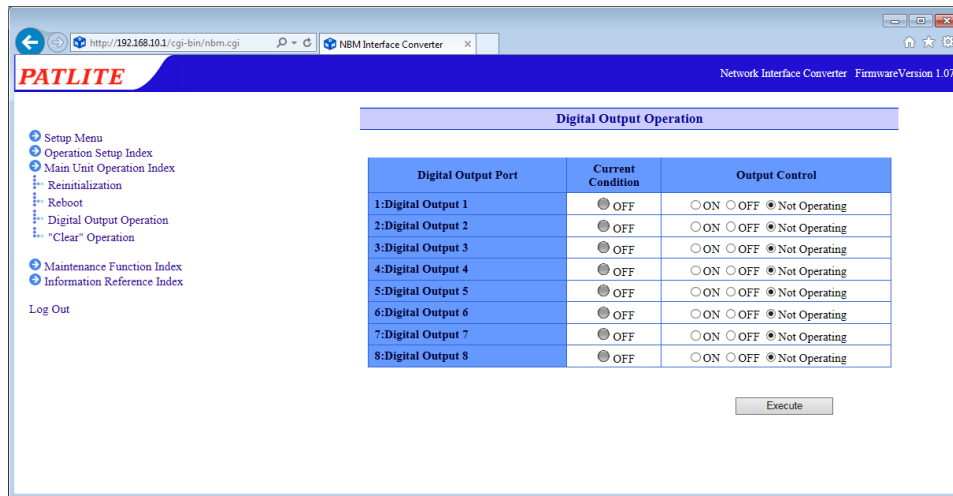

Fig. 4.20.0-1 Digital output operation setting screen

Table 4.20.3-1 Digital Output Operation Setting Parameters

Item	Contents	Default Value	Input Parameter	Setup Option
Current Condition	Displays the current status of the digital output.	—	—	—
Output Control	Select the operation of each digital output port among "ON", "OFF", "Not operating".	Not operating	—	—

## 4.21 "Clear" Operation Screen

Execute the "Clear" operation.

Execute the "Clear" operation.

When "Execute Clear" is performed, all 8 of the digital output ports are turned OFF.

Application monitoring and Ping monitoring are changed from abnormal state to monitoring state. The values (time and number) accumulated in the input condition setting is erased.

### [Setup Method]

- 1 Click the "Execute Clear" button.

#### Attention

- When an "Execute Clear" is performed, the output terminal block is actually turned OFF, according to the "Digital Output Settings" set up. Be very careful when executing a "Clear" operation.
- When a "Clear" execution is performed during the monitor abnormality status, it returns to the monitoring status.
- Ports set as "Inactive" by "Digital Output Settings" are not cleared.
- When returning to a monitoring condition, it will not work for an abnormality recovery. Moreover, when the monitoring object is still in an abnormal condition (No Ping Acknowledgement for the application monitor), in accordance to the monitor set up, the monitor abnormality operation is performed again.

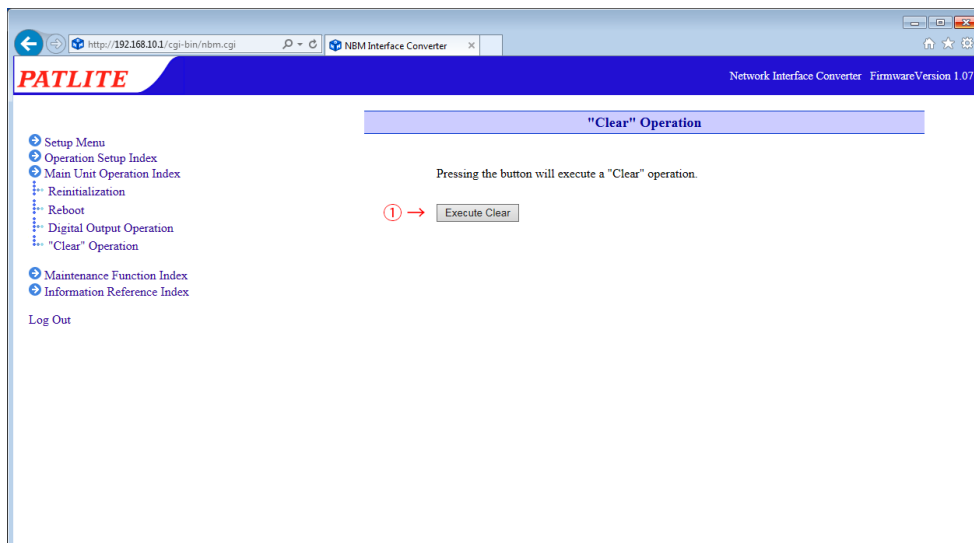

Fig. 4.21.0-1 "Clear" operation screens

## 4.22 Firmware Update Screen

The firmware for this product can be updated.

### [Setup Method]

- ① Click the "Browse..." button to select the firmware to be written into this product.
- ② Clicking the "update" button will start the firmware update.

The update may take up to 5 minutes. When the update is complete, the message "It is now rebooting. Please wait a moment." will play and the product will reboot automatically.

### Attention

- Do not disconnect the power cable or LAN cable during the update. Possible cause of failure may occur.
- Be sure to verify the object model and firmware version before executing an update. If an object is not selected when the firmware is to be updated, it will result in a cause of failure to this product.
- Firmware Ver 2.00 or later cannot downgrade to less than Ver 2.00 firmware.

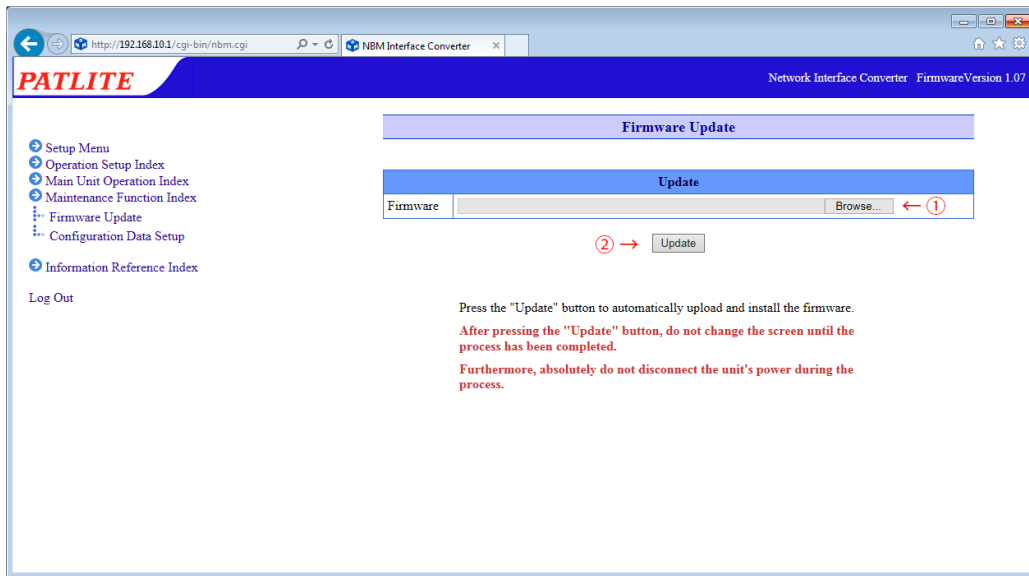

Fig. 4.22.0-1 Firmware Update setting screen

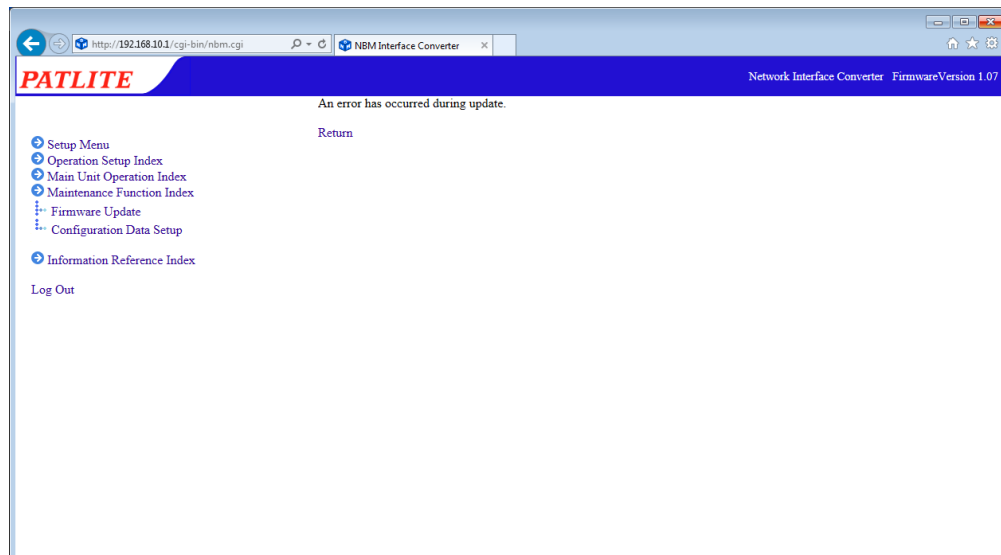

Fig. 4.22.0-2 Firmware Update Failure screen

### MEMO

Fig. 4.22.2 shows the type of screen in case an error occurs during the firmware update. If the update fails, make sure that the firmware, then update again after confirmation. If an error repeatedly occurs during the firmware update process, please contact your nearest Patlite Sales Representative.

## 4.23 Configuration Data Setup Screen

The setting menu for this product is read and can be saved as configuration data on the PC. Moreover, the configuration file read off of this product can be selected and uploaded.

**MEMO**

The network setup and user information is not included in the config data.

### [Setup Method]

#### << Reading Configuration Data >>

- ① Click the "Load" button to save the configuration data on the PC.

#### << Writing Configuration Data >>

- ② Click the "Browse..." button and select the configuration data to be written to this product.
- ③ Click the "Write" button to start the uploading of the configuration data. After the configuration data is uploaded, this product will automatically reboot.

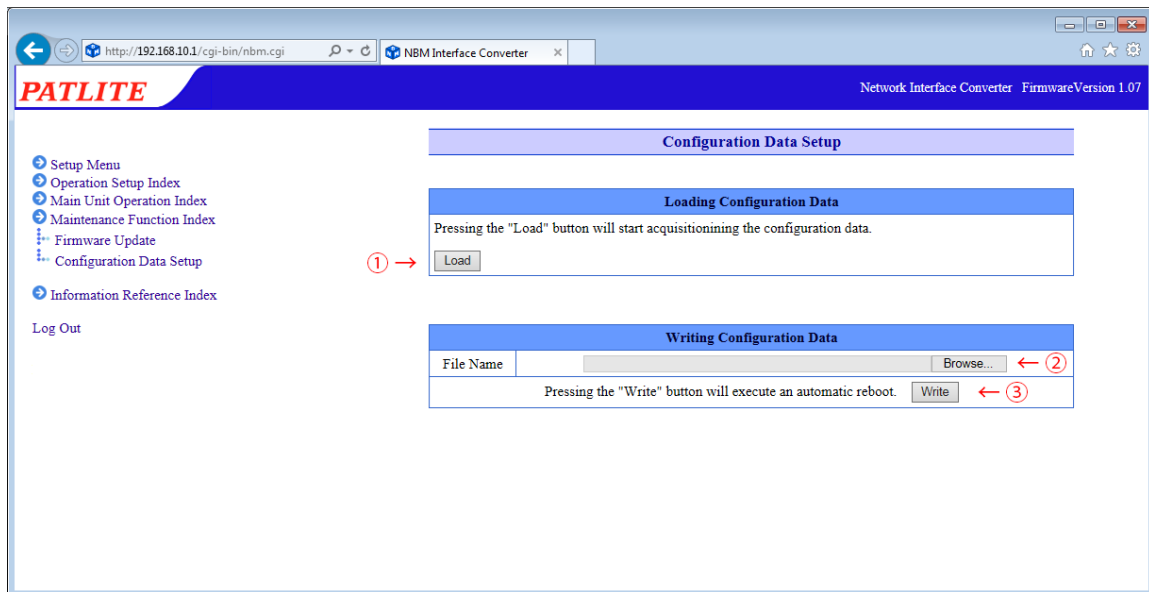

Fig. 4.23.0-1 Configuration Data Setup screen

## 4.24 Status Log Screen

To retrieve the status log for this product, set the output method and display, then download the log. In addition, 100 status logs are displayed in the newest order.

### [Setup Method]

- ① Select between "polling" or "event" from "Log Output Format."
- ② When "Polling" is selected, enter the number of seconds (1 to 300) for "Polling Output Interval."
- ③ Click the "Set" button to activate the setup.

### [Downloading Method]

- ④ Click the "Download" button.

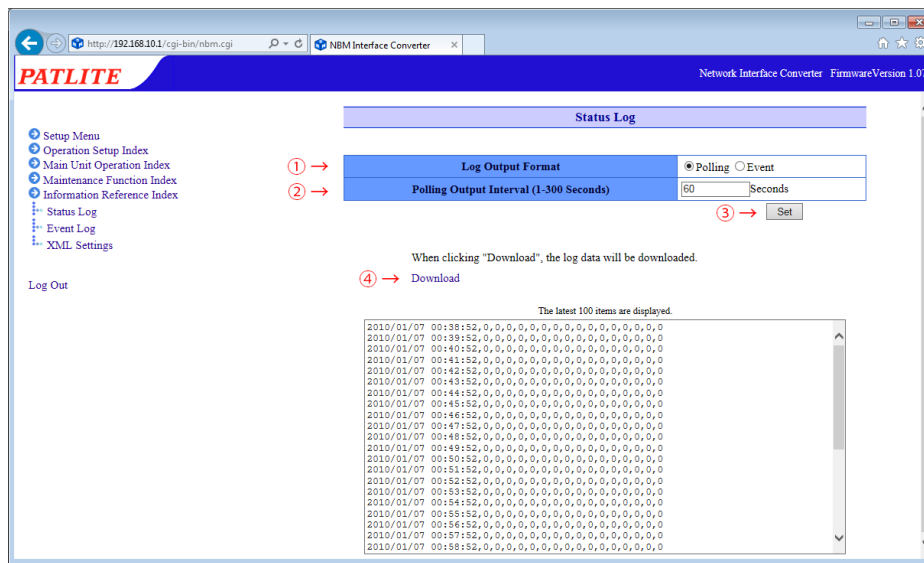

Fig. 4.24.0-1 Status Log screen

Table 4.24.3-1 Status log parameters

Item	Contents	Default Value	Input Parameter	Setup Option
Log Output Format	Select the trigger to export the status log from "Polling"/"Event".	Polling	—	—
Polling Output Interval	The interval which outputs a log is entered.	60	1-300	—

## 4.25 Event Log Screen

The event log of this product can be downloaded and checked. Moreover, 100 operation logs are displayed on new order.

### [Setup Method]

- 1 Click the "Download" button.

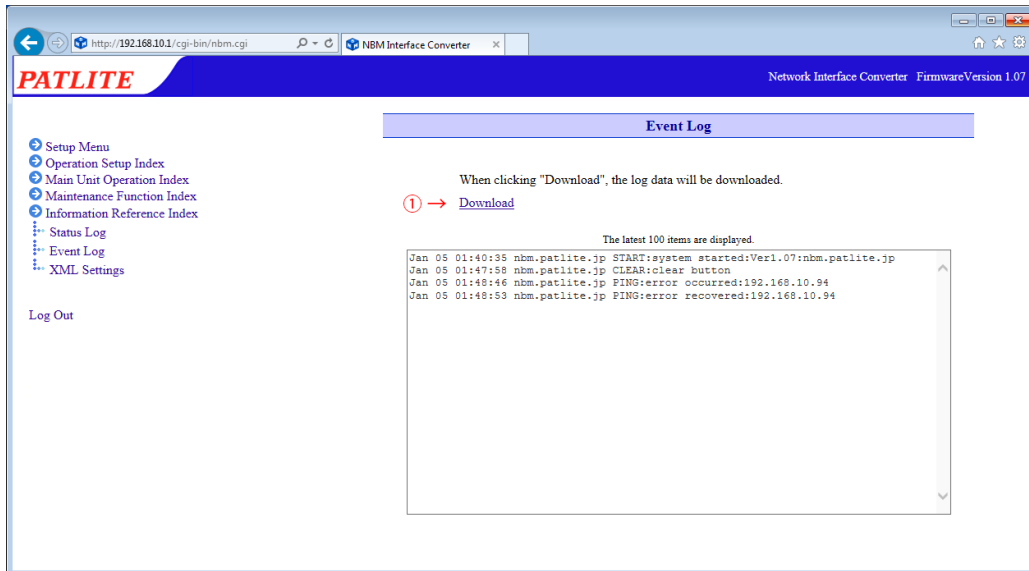

Fig. 4.25.0-1 Event Log screen

MEMO

The number of saved logs is up to 50,000. Overdrafts are deleted in order of oldest.



## 4.26 XML Settings Screen

The following is the setup and download for the XML data output from this product.

### [Setup Method]

- ① Select "Active" to export XML data. Select "Inactive", when not exporting an XML data output.
- ② Be sure to select the authentication method among "Login Authentication" or "No Authentication" when directly specifying the URL and acquiring the data.
- ③ Click "Download" to download the XML data.  
(It will only be downloadable when the "XML file output" is set as "Active")
- ④ Click the "Set" button to activate the setup.

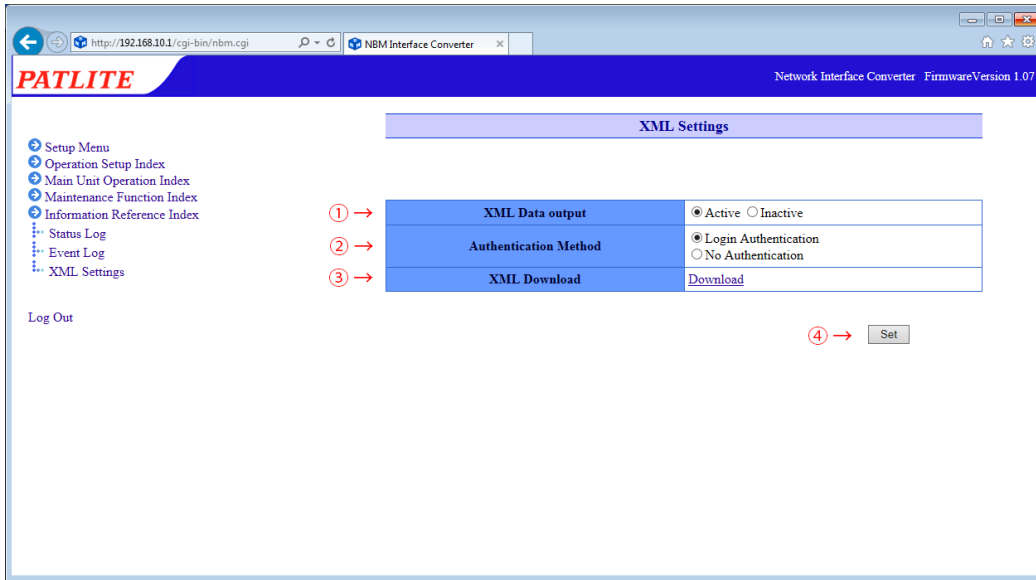

Fig. 4.26.0-1 XML Data screen

#### Attention

- If the authentication method is set for "No Authentication", the XML data can be acquired without logging in for authentication of a Web setup tool.
- If set to "Login Authentication", login authentication of the Web setup tool is necessary when acquisitoning an XML file.

#### MEMO

An XML file is downloadable only when the XML file output is set as "Active."

Table 4.26.0-1 XML Data Setup Parameters

Item	Contents	Default Value	Input Parameter	Setup Option
XML Data Output	Set either "Active" or "Inactive" for the XML data output function.	Inactive	—	—
Authentication Method	Select the authentication, when designating directly with a URL and acquisitioning an XML data output.	Login Authentication	—	—
XML Download	XML data is downloaded.	—	—	—

# 5. MIB

With this product, there is an exclusive MIB (Management Information Base) for the NBM Series, and the monitor controls can be operated by the SNMP manager, etc.

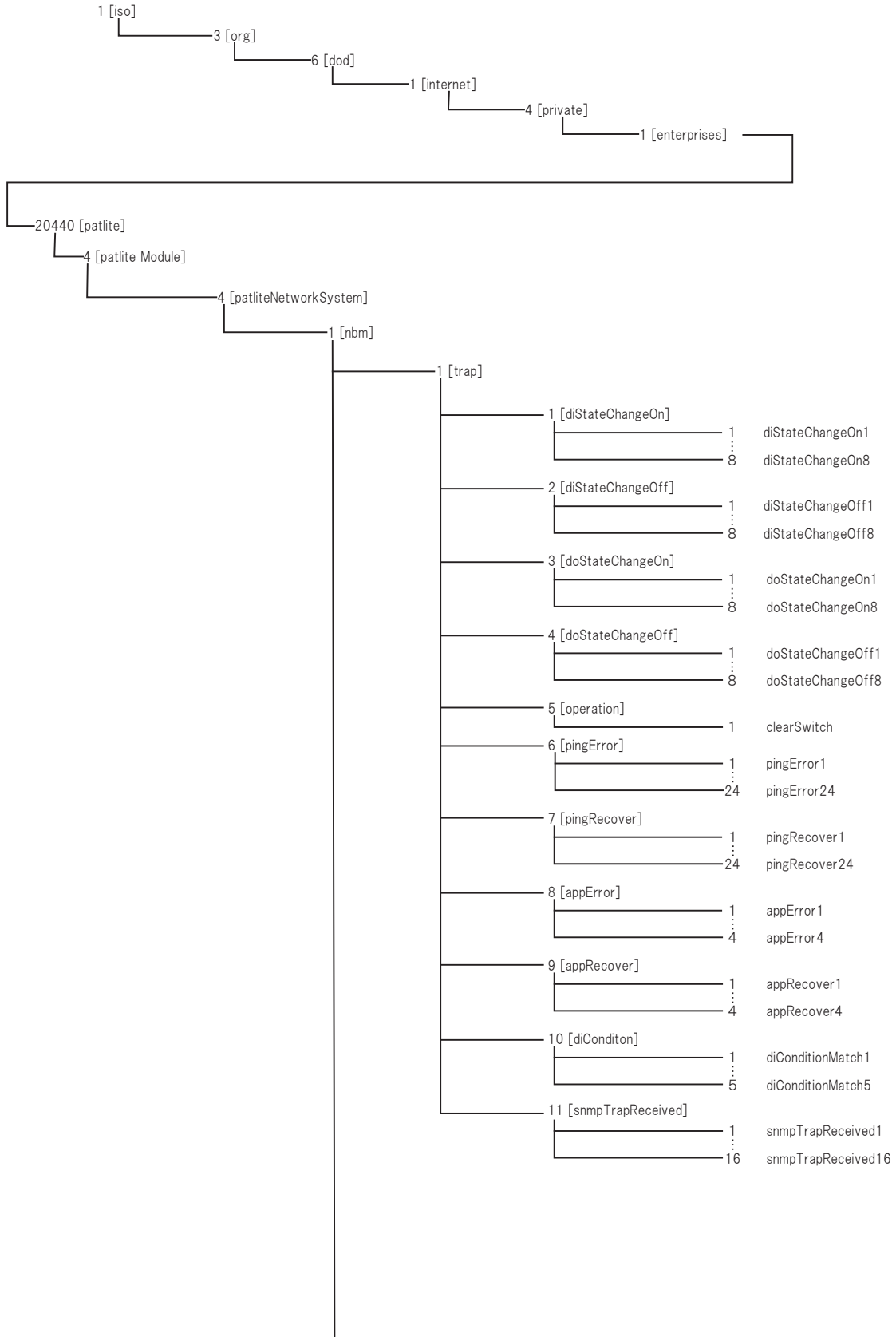

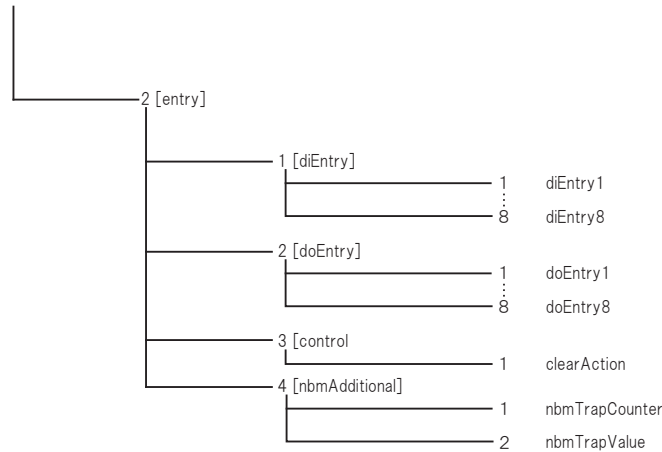

Table 5.0.0-1 Generic Trap

OID	Name	Type	MAX-ACCESS	Description
1.3.6.1.6.3.1.1.5.1	coldStart	OBJECT-IDENTIFIER	not-accessible	It sends as soon as the Main Unit starts.

Table 5.0.0-2 net-snmp

OID	Name	Type	MAX-ACCESS	Description
1.3.6.1.2.1.1	system			
1.3.6.1.2.1.1.3	sysUpTime	TimeTick	read-only	The time elapsed after the SNMP management system has rebooted. (in 1/100 seconds)
1.3.6.1.2.1.1.4	sysContact	DisplayString (SIZE (0..255))	read-only	It is the contact for the Web setup tool System Setup.
1.3.6.1.2.1.1.5	sysName	DisplayString (SIZE (0..255))	read-only	It is the host name for the Web setup tool System Setup.
1.3.6.1.2.1.1.6	sysLocation	DisplayString (SIZE (0..255))	read-only	It is a installation location for the Web setup tool System Setup.

Table 5.0.0-3 NBM-D88 OID Characteristics

OID	Name	Type	MAX-ACCESS	Description
4	Patlite Module			
4.4	patliteNetworkSystem			
4.4.1	NBM			
4.4.1.1	Trap			
4.4.1.1.1	diStateChangeON			
4.4.1.1.1.1 - 4.4.1.1.1.8	diStateChangeOn1 - 8	OBJECT-IDENTIFIER	not-accessible	It will transmit when the digital inputs 1-8 are turned on.
4.4.1.1.2	diStateChangeOFF			
4.4.1.1.2.1 - 4.4.1.1.2.8	diStateChangeOff1 - 8	OBJECT-IDENTIFIER	not-accessible	It will transmit when the digital inputs 1-8 are turned OFF.
4.4.1.1.3	doStateChangeON			
4.4.1.1.3.1 - 4.4.1.1.3.8	doStateChangeOn1 - 8	OBJECT-IDENTIFIER	not-accessible	It will transmit when the digital outputs 1-8 are turned ON.
4.4.1.1.4	doStateChangeOFF			
4.4.1.1.4.1 - 4.4.1.1.4.8	doStateChangeOff1 - 8	OBJECT-IDENTIFIER	not-accessible	It will transmit when the digital outputs 1-8 are turned OFF.
4.4.1.1.5	operation			
4.4.1.1.5.1	clearSwitch	OBJECT-IDENTIFIER	not-accessible	It will transmit when the "Clear" switch is pushed.



Table 5.0.0-4 (Continuation of Table 5.0.0-3) NBM-D88 OID Characteristics

OID	Name	Type	MAX-ACCESS	Description
4.4.1.1.6	pingError			
4.4.1.1.6.1 - 4.4.1.1.6.24	pingError1 - 24	OBJECT-IDENTIFIER	not-accessible	The monitoring object set up for the Ping monitor setups 1-24 can transmit when abnormalities occur.
4.4.1.1.7	pingRecover			
4.4.1.1.7.1 - 4.4.1.1.7.24	pingRecover1 - 24	OBJECT-IDENTIFIER	not-accessible	The monitoring object set up for the Ping monitor setups 1-24 can transmit when recovery from an abnormality occurs.
4.4.1.1.8	appError			
4.4.1.1.8.1 - 4.4.1.1.8.4	appError1 - 4	OBJECT-IDENTIFIER	not-accessible	The monitoring object set up for when the Application monitor setups 1-24 can transmit when abnormalities occur.
4.4.1.1.9	appRecover			
4.4.1.1.9.1 - 4.4.1.1.9.4	appRecover1 - 4	OBJECT-IDENTIFIER	not-accessible	The monitoring object set up for when the Application monitor setups 1-24 can transmit when recovery from an abnormality occurs.
4.4.1.1.10	diConditionMatch			
4.4.1.1.10.1 - 4.4.1.1.10.5	diConditionMatch 1 - 5	OBJECT-IDENTIFIER	not-accessible	It transmits when the conditions set up in the digital input condition setup 1-5 agrees.
4.4.1.1.11	snmpTrapReceived			
4.4.1.1.11.1 - 4.4.1.1.11.16	snmpTrapReceived 1 - 16	OBJECT-IDENTIFIER	not-accessible	It will transmit when the TRAP, set up by the TRAP reception setting 1-16, is received.
4.4.1.2	Entry			
4.4.1.2.1	diEntry			
4.4.1.2.1.1 - 4.4.1.2.1.8	diEntry1 - 8	INTEGER { off(0), on(1) }	read-only	The digital input status 1-8 is stored.
4.4.1.2.2	doEntry			
4.4.1.2.2.1 - 4.4.1.2.2.8	doEntry1 - 8	INTEGER { off(0), on(1) }	read-write	The digital output status 1-8 is stored. The digital output can be controlled by an SNMP SET command.
4.4.1.2.3	control			
4.4.1.2.3.1	clearAction	INTEGER { nop(0), execute(1) }	read-write	The digital output and abnormal condition can be cleared with an SNMP SET command. Do nothing (0) / Execute (1)
4.4.1.2.4	nbmAdditional			
4.4.1.2.4.1	nbmTrapCounter	INTEGER { 0.. 2147483647 }	read-only	It stores the number of times the Trap was sent since the product started up. Traps are transmitted multiple times. When set, the same numerical value is stored in the Trap for the same event.
4.4.1.2.4.2	nbmTrapValue	INTEGER { off(0), on(1) }	read-only	Stores the value of the port that triggered the event transmission when sending a Trap, due to a digital input/output event. OFF(0) / ON(1)

**MEMO**

In order to transmit the trap OID that notifies the occurrence of each event from the main unit, it is necessary to set the "Trap Transmission" in the condition Setup of each function as "Active."

# 6. Replacement and Option Parts

This section covers replacement parts for repair and optional items for this product.

## 6.1 Replacement Parts List

The replacement parts list for this products is shown in the table below. When replacement parts are necessary, direct your inquiries to the store where this product was purchased.

Table 6.1.0-1 NBM Series Replacement Parts

Model Name	Part Name	Part Number
NBM-D88	Rubber Feet	T81800027-F1
	Terminal Buss Cover	Z69544921-F1

## 6.2 Option Parts

The following option parts for this product are available.

Table 6.2.0-1 Optional Parts

Model Name	Part Name	Part Number
NBM-ANG	Angle type server rack attachment	NBM-ANG

\* For further details on the server rack mounting angle, refer to "2.2.2 When using the Angle Type Server Rack Attachment (Optional)."



# 7. Maintenance and Inspection

## Cleaning

- When cleaning, be sure to disconnect the power before starting.
- The cleaning of this product should be with a soft cloth and a neutral detergent (such as dish soap), diluted with water and should be wiped lightly.
- Do not wipe this product with volatile chemicals, or chemically treated dustcloth containing benzine, thinner etc.
- Do not wipe with a cloth containing too much moisture. If moisture gets inside the product, it can cause short circuiting, electric shock, or fire.
- Periodically remove dust from the electric socket to prevent a fire hazard. By allowing dust to adhere to the power supply terminal, it can be the result of fire or failure from short-circuiting.

## Inspection

- Be sure to check the following points when inspecting this product.

Table 7.2.3-1 Inspection Checklist

Inspection Items		Inspection Contents
Supplied Power Source	Power Supply Voltage Tolerance	Tolerable Voltage Range should be from 100 to 240V AC
Surrounding Environment	Operation at ambient temperature	Operating temperature range is between 0 and 40°C.
	Ambient Humidity	Operating ambient humidity is between 20 and 80%.
	Presence of Dust	No dust should be accumulated
Is the wiring or cord loose or have too much slack?		Be sure no excessive slack or looseness is present.



## 8. Troubleshooting

Problem	Possible Cause
The power source is not turned on.	Check whether the AC Adaptor is properly connected.
Voltage is not supplied from the output power source Terminal Bus.	The protection circuit may have worked. Turn off the power to this product and check the wiring and equipment connected to the output power source Terminal Bus. Please turn on this product after a while to check that it is starting up normally. Since there is a possibility of internal damage if it does not start, discontinue the use of this product and contact your nearest PATLITE Sales Representative.
The LED on the Main Unit will stop half-way.	Even by doing nothing but wait 1 minute or more as it is, it should start, but in cases where it does not change, contact the place of purchase or a PATLITE Sales Representative.
It does not operate in DHCP mode.	Check that the environment is connectable with a DHCP server.
The Web setup tool is not displayed.	Check that the LAN cable is connected (LINK display LED lights up).
When logging into the Web setup tool, a browser error occurs.	Check whether the IP address etc. which is displayed on the address bar of the browser is correct.
	Also check if the network Setup of the PC using the browser is connected with this product.
The output terminal block does not move. The output terminal block does not operate as it is supposed to be controlled to do.	Be sure whether the digital output is set as "Active" or not. <b>[Where to Check]</b> [Web Setup Tool] -> "Operation Setup Intex" -> "Digital Output Setup"
	Check whether the digital output status is changing for a short time. An output terminal reflects the digital output status in a 100 ms cycle. The digital output status is updated as required in the order of received control content. (Priority is given to the last) For this reason, when the digital output status changes within 100 ms, only that portion of the status occurs in the output terminal. * Various transmission commands and E-mail Sending reflects the order of control content.
	When a lot of management happens in other functions or when management takes time, an output terminal operation may be delayed.
	Check whether the "Automatic OFF" is set.
	Contact parts may be damaged. Refer to the information at the end of this book, or ask the store where the product was purchased. Check whether the rated current of the equipment linked to the Terminal Buss and the inrush current were over the output terminal ratings.
A digital input does not turn on (status change is not detected). The digital input does not turn off.	Check whether the "Digital Input Setup" is set to "Active." <b>[Where to Check]</b> [Web Setup Tool] -> "Operation Setup Intex" -> "Digital Input Setup"
	Check whether there are no open circuits, unconnected wires, short circuit, etc. in the input terminal wiring.
	Check whether the input signal is correctly transmitting to the input terminal. The input signal requires a current value of 1 mA or more and a duration of 110 ms or more.

Problem	Possible Cause
Socket transmission and RSH command transmission are not sent with the following functions: <ul style="list-style-type: none"> <li>• Digital input Monitoring Function</li> <li>• Application Monitoring Function</li> <li>• Ping Monitoring Function</li> <li>• "Clear" Switch Function</li> <li>• Digital input condition Setup Function</li> </ul>	Check the Settings which can be received by the destination equipment. (Port number, protocol, account etc.)
	Check whether the setting of the information to the addressee is correct. <b>[Where to Check]</b> [Web Setup Tool] -> "Setup Menu" -> "Socket Transmission Configuration" or "RSH Command Transmission Configuration"
	Please check the settings of the communication devices on the route to the destination; such as the firewall, filtering, port block functions etc., to ensure communication is not cut off.
	When the setup is by the host name, check whether the DNS server address is correctly set up. <b>[Where to Check]</b> [Web Setup Tool] -> "Setup Menu" -> "System Configuration"
	If a large amount of socket transmissions or RSH command transmissions occurs in a short time, the transmission processing can not catch up and the newly generated transmission processing is discarded and is not transmitted. Be sure to reduce the number of socket transmission or RSH command transmission functions, or allow enough time between events to trigger transmissions.
It takes time until the socket transmission or RSH transmission is transmitted with the following functions: <ul style="list-style-type: none"> <li>• Digital input Monitoring Function</li> <li>• Application Monitoring Function</li> <li>• Ping Monitoring Function</li> <li>• "Clear" Switch Function</li> <li>• Digital input condition Setup Function</li> </ul>	If a large amount of socket transmissions or RSH command transmissions occurs in a short time, the transmission processing can not catch up and the newly generated transmission processing is discarded and is not transmitted. Be sure to reduce the number of socket transmission or RSH command transmission functions, or allow enough time between events to trigger transmissions.
	Check whether the setting of the information to the addressee is correct. If the incorrect information is set, it will take time to send. <b>[Where to Check]</b> [Web Setup Tool] -> "Setup Menu" -> "Socket Transmission Configuration" or "RSH Command Transmission Configuration"
The status logs and the operation logs are not recorded.	The status log and operation log are first written to the main memory (DRAM) and written to the internal flash memory at regular intervals. Among these, the main memory log is not saved, and it is erased when either "Power Off", "Restart", or "Press the reset button" is done before the flash memory was written to.
It takes time to display the status log and the operation log on the Web setup tool.	The log displayed by the Web setting tool is the log written to the internal flash memory. When a large amount of logs are generated in a short time, the writing process to the flash memory can not keep up and a delay occurs. Since log information is kept in the main memory, wait until the display is updated.
HTTP command cannot be controlled.	Check whether the "HTTP command control function" is set to "Active." <b>[Where to Check]</b> [Web Setup Tool] -> "Setup Menu" -> "System Configuration"





# 9. Conditions for Freeware Utilization Consent

In this chapter, the copyright of the freeware used with this product is clearly written.

## 9.1 GNU GENERAL PUBLIC LICENCE

### 9.1.1 Version 2.0

GNU GENERAL PUBLIC LICENSE

Version 2, June 1991

Copyright (C) 1989, 1991 Free Software Foundation, Inc.

675 Mass Ave, Cambridge, MA 02139, USA

Everyone is permitted to copy and distribute verbatim copies of this license document, but changing it is not allowed.

#### Preamble

The licenses for most software are designed to take away your freedom to share and change it. By contrast, the GNU General Public License is intended to guarantee your freedom to share and change free software--to make sure the software is free for all its users. This General Public License applies to most of the Free Software Foundation's software and to any other program whose authors commit to using it. (Some other Free Software Foundation software is covered by the GNU Library General Public License instead.) You can apply it to your programs, too.

When we speak of free software, we are referring to freedom, not price. Our General Public Licenses are designed to make sure that you have the freedom to distribute copies of free software (and charge for this service if you wish), that you receive source code or can get it if you want it, that you can change the software or use pieces of it in new free programs; and that you know you can do these things.

To protect your rights, we need to make restrictions that forbid anyone to deny you these rights or to ask you to surrender the rights. These restrictions translate to certain responsibilities for you if you distribute copies of the software, or if you modify it.

For example, if you distribute copies of such a program, whether gratis or for a fee, you must give the recipients all the rights that you have. You must make sure that they, too, receive or can get the source code. And you must show them these terms so they know their rights.

We protect your rights with two steps: (1) copyright the software, and (2) offer you this license which gives you legal permission to copy, distribute and/or modify the software.

Also, for each author's protection and ours, we want to make certain that everyone understands that there is no warranty for this free software. If the software is modified by someone else and passed on, we want its recipients to know that what they have is not the original, so that any problems introduced by others will not reflect on the original authors' reputations.

Finally, any free program is threatened constantly by software patents. We wish to avoid the danger that redistributors of a free program will individually obtain patent licenses, in effect making the program proprietary. To prevent this, we have made it clear that any patent must be licensed for everyone's free use or not licensed at all.

The precise terms and conditions for copying, distribution and modification follow.

GNU GENERAL PUBLIC LICENSE

TERMS AND CONDITIONS FOR COPYING, DISTRIBUTION AND MODIFICATION

0. This License applies to any program or other work which contains a notice placed by the copyright holder saying it may be distributed under the terms of this General Public License. The "Program", below, refers to any such program or work, and a "work based on the Program" means either the Program or any derivative work under copyright law: that is to say, a work containing the Program or a portion of it, either verbatim or with modifications and/or translated into another language. (Hereinafter, translation is included without limitation in the term "modification".) Each licensee is addressed as "you".

Activities other than copying, distribution and modification are not covered by this License; they are outside its scope. The act of running the Program is not restricted, and the output from the Program is covered only if its contents constitute a work based on the Program (independent of having been made by running the Program). Whether that is true depends on what the Program does.

1. You may copy and distribute verbatim copies of the Program's source code as you receive it, in any medium, provided that you conspicuously and appropriately publish on each copy an appropriate copyright notice and disclaimer of warranty; keep intact all the notices that refer to this License and to the absence of any warranty; and give any other recipients of the Program a copy of this License along with the Program.

You may charge a fee for the physical act of transferring a copy, and you may at your option offer warranty protection in exchange for a fee.

2. You may modify your copy or copies of the Program or any portion of it, thus forming a work based on the Program, and copy and distribute such modifications or work under the terms of Section 1 above, provided that you also meet all of these conditions:
  - a) You must cause the modified files to carry prominent notices stating that you changed the files and the date of any change.
  - b) You must cause any work that you distribute or publish, that in whole or in part contains or is derived from the Program or any part thereof, to be licensed as a whole at no charge to all third parties under the terms of this License.
  - c) If the modified program normally reads commands interactively when run, you must cause it, when started running for such interactive use in the most ordinary way, to print or display an announcement including an appropriate copyright notice and a notice that there is no warranty (or else, saying that you provide a warranty) and that users may redistribute the program under these conditions, and telling the user how to view a copy of this License. (Exception: if the Program itself is interactive but does not normally print such an announcement, your work based on the Program is not required to print an announcement.)

These requirements apply to the modified work as a whole. If identifiable sections of that work are not derived from the Program, and can be reasonably considered independent and separate works in themselves, then this License, and its terms, do not apply to those sections when you distribute them as separate works. But when you distribute the same sections as part of a whole which is a work based on the Program, the distribution of the whole must be on the terms of this License, whose permissions for other licensees extend to the entire whole, and thus to each and every part regardless of who wrote it.

Thus, it is not the intent of this section to claim rights or contest your rights to work written entirely by you; rather, the intent is to exercise the right to control the distribution of derivative or collective works based on the Program.

In addition, mere aggregation of another work not based on the Program with the Program (or with a work based on the Program) on a volume of a storage or distribution medium does not bring the other work under the scope of this License.

3. You may copy and distribute the Program (or a work based on it, under Section 2) in object code or executable form under the terms of Sections 1 and 2 above provided that you also do one of the following:
  - a) Accompany it with the complete corresponding machine-readable source code, which must be distributed under the terms of Sections 1 and 2 above on a medium customarily used for software interchange; or,
  - b) Accompany it with a written offer, valid for at least three years, to give any third party, for a charge no more than your cost of physically performing source distribution, a complete machine-readable copy of the corresponding source code, to be distributed under the terms of Sections 1 and 2 above on a medium customarily used for software interchange; or,
  - c) Accompany it with the information you received as to the offer to distribute corresponding source code. (This alternative is allowed only for noncommercial distribution and only if you received the program in object code or executable form with such an offer, in accord with Subsection b above.)

The source code for a work means the preferred form of the work for making modifications to it. For an executable work, complete source code means all the source code for all modules it contains, plus any associated interface definition files, plus the scripts used to control compilation and installation of the executable. However, as a special exception, the source code distributed need not include anything that is normally distributed (in either source or binary form) with the major components (compiler, kernel, and so on) of the operating system on which the executable runs, unless that component itself accompanies the executable.

If distribution of executable or object code is made by offering access to copy from a designated place, then offering equivalent access to copy the source code from the same place counts as distribution of the source code, even

though third parties are not compelled to copy the source along with the object code.

4. You may not copy, modify, sublicense, or distribute the Program except as expressly provided under this License. Any attempt otherwise to copy, modify, sublicense or distribute the Program is void, and will automatically terminate your rights under this License. However, parties who have received copies, or rights, from you under this License will not have their licenses terminated so long as such parties remain in full compliance.
5. You are not required to accept this License, since you have not signed it. However, nothing else grants you permission to modify or distribute the Program or its derivative works. These actions are prohibited by law if you do not accept this License. Therefore, by modifying or distributing the Program (or any work based on the Program), you indicate your acceptance of this License to do so, and all its terms and conditions for copying, distributing or modifying the Program or works based on it.
6. Each time you redistribute the Program (or any work based on the Program), the recipient automatically receives a license from the original licensor to copy, distribute or modify the Program subject to these terms and conditions. You may not impose any further restrictions on the recipients' exercise of the rights granted herein. You are not responsible for enforcing compliance by third parties to this License.
7. If, as a consequence of a court judgment or allegation of patent infringement or for any other reason (not limited to patent issues), conditions are imposed on you (whether by court order, agreement or otherwise) that contradict the conditions of this License, they do not excuse you from the conditions of this License. If you cannot distribute so as to satisfy simultaneously your obligations under this License and any other pertinent obligations, then as a consequence you may not distribute the Program at all. For example, if a patent license would not permit royalty-free redistribution of the Program by all those who receive copies directly or indirectly through you, then the only way you could satisfy both it and this License would be to refrain entirely from distribution of the Program.

If any portion of this section is held invalid or unenforceable under any particular circumstance, the balance of the section is intended to apply and the section as a whole is intended to apply in other circumstances.

It is not the purpose of this section to induce you to infringe any patents or other property right claims or to contest validity of any such claims; this section has the sole purpose of protecting the integrity of the free software distribution system, which is implemented by public license practices. Many people have made generous contributions to the wide range of software distributed through that system in reliance on consistent application of that system; it is up to the author/donor to decide if he or she is willing to distribute software through any other system and a licensee cannot impose that choice.

This section is intended to make thoroughly clear what is believed to be a consequence of the rest of this License.

8. If the distribution and/or use of the Program is restricted in certain countries either by patents or by copyrighted interfaces, the original copyright holder who places the Program under this License may add an explicit geographical distribution limitation excluding those countries, so that distribution is permitted only in or among countries not thus excluded. In such case, this License incorporates the limitation as if written in the body of this License.
9. The Free Software Foundation may publish revised and/or new versions of the General Public License from time to time. Such new versions will be similar in spirit to the present version, but may differ in detail to address new problems or concerns.

Each version is given a distinguishing version number. If the Program specifies a version number of this License which applies to it and "any later version", you have the option of following the terms and conditions either of that version or of any later version published by the Free Software Foundation. If the Program does not specify a version number of this License, you may choose any version ever published by the Free Software Foundation.

10. If you wish to incorporate parts of the Program into other free programs whose distribution conditions are different, write to the author to ask for permission. For software which is copyrighted by the Free Software Foundation, write to the Free Software Foundation; we sometimes make exceptions for this. Our decision will be guided by the two goals of preserving the free status of all derivatives of our free software and of promoting the sharing and reuse of software generally.

#### NO WARRANTY

11. BECAUSE THE PROGRAM IS LICENSED FREE OF CHARGE, THERE IS NO WARRANTY FOR THE PROGRAM, TO THE EXTENT PERMITTED BY APPLICABLE LAW. EXCEPT WHEN OTHERWISE STATED IN WRITING THE COPYRIGHT HOLDERS AND/OR OTHER PARTIES PROVIDE THE PROGRAM "AS IS" WITHOUT WARRANTY OF ANY KIND, EITHER EXPRESSED OR IMPLIED, INCLUDING, BUT NOT LIMITED TO, THE IMPLIED WARRANTIES OF MERCHANTABILITY AND FITNESS FOR A PARTICULAR PURPOSE. THE ENTIRE RISK AS TO THE QUALITY AND PERFORMANCE OF THE PROGRAM IS WITH YOU. SHOULD THE PROGRAM PROVE DEFECTIVE, YOU ASSUME THE COST OF ALL NECESSARY SERVICING, REPAIR OR CORRECTION.



12. IN NO EVENT UNLESS REQUIRED BY APPLICABLE LAW OR AGREED TO IN WRITING WILL ANY COPYRIGHT HOLDER, OR ANY OTHER PARTY WHO MAY MODIFY AND/OR REDISTRIBUTE THE PROGRAM AS PERMITTED ABOVE, BE LIABLE TO YOU FOR DAMAGES, INCLUDING ANY GENERAL, SPECIAL, INCIDENTAL OR CONSEQUENTIAL DAMAGES ARISING OUT OF THE USE OR INABILITY TO USE THE PROGRAM (INCLUDING BUT NOT LIMITED TO LOSS OF DATA OR DATA BEING RENDERED INACCURATE OR LOSSES SUSTAINED BY YOU OR THIRD PARTIES OR A FAILURE OF THE PROGRAM TO OPERATE WITH ANY OTHER PROGRAMS), EVEN IF SUCH HOLDER OR OTHER PARTY HAS BEEN ADVISED OF THE POSSIBILITY OF SUCH DAMAGES.

END OF TERMS AND CONDITIONS

#### Appendix: How to Apply These Terms to Your New Programs

If you develop a new program, and you want it to be of the greatest possible use to the public, the best way to achieve this is to make it free software which everyone can redistribute and change under these terms.

To do so, attach the following notices to the program. It is safest to attach them to the start of each source file to most effectively convey the exclusion of warranty; and each file should have at least the "copyright" line and a pointer to where the full notice is found.

<one line to give the program's name and a brief idea of what it does.>

Copyright (C) 19yy <name of author>

This program is free software; you can redistribute it and/or modify it under the terms of the GNU General Public License as published by the Free Software Foundation; either version 2 of the License, or (at your option) any later version.

This program is distributed in the hope that it will be useful, but WITHOUT ANY WARRANTY; without even the implied warranty of MERCHANTABILITY or FITNESS FOR A PARTICULAR PURPOSE. See the GNU General Public License for more details.

You should have received a copy of the GNU General Public License along with this program; if not, write to the Free Software Foundation, Inc., 675 Mass Ave, Cambridge, MA 02139, USA.

Also add information on how to contact you by electronic and paper mail.

If the program is interactive, make it output a short notice like this when it starts in an interactive mode:

Gnomovision version 69, Copyright (C) 19yy name of author

Gnomovision comes with ABSOLUTELY NO WARRANTY; for details type `show w'. This is free software, and you are welcome to redistribute it under certain conditions; type `show c' for details.

The hypothetical commands `show w' and `show c' should show the appropriate parts of the General Public License. Of course, the commands you use may be called something other than `show w' and `show c'; they could even be mouse-clicks or menu items--whatever suits your program.

You should also get your employer (if you work as a programmer) or your school, if any, to sign a "copyright disclaimer" for the program, if necessary. Here is a sample; alter the names:

Yoyodyne, Inc., hereby disclaims all copyright interest in the program `Gnomovision' (which makes passes at compilers) written by James Hacker.

<signature of Ty Coon>, 1 April 1989

Ty Coon, President of Vice

This General Public License does not permit incorporating your program into proprietary programs. If your program is a subroutine library, you may consider it more useful to permit linking proprietary applications with the library. If this is what you want to do, use the GNU Library General Public License instead of this License.

## 9.1.2 Version 3.0

### GNU GENERAL PUBLIC LICENSE

Version 3, 29 June 2007

Copyright (C) 2007 Free Software Foundation, Inc. <<http://fsf.org/>> Everyone is permitted to copy and distribute verbatim copies of this license document, but changing it is not allowed.

#### Preamble

The GNU General Public License is a free, copyleft license for software and other kinds of works.

The licenses for most software and other practical works are designed to take away your freedom to share and change the works. By contrast, the GNU General Public License is intended to guarantee your freedom to share and change all versions of a program—to make sure it remains free software for all its users. We, the Free Software Foundation, use the GNU General Public License for most of our software; it applies also to any other work released this way by its authors. You can apply it to your programs, too.

When we speak of free software, we are referring to freedom, not price. Our General Public Licenses are designed to make sure that you have the freedom to distribute copies of free software (and charge for them if you wish), that you receive source code or can get it if you want it, that you can change the software or use pieces of it in new free programs, and that you know you can do these things.

To protect your rights, we need to prevent others from denying you these rights or asking you to surrender the rights. Therefore, you have certain responsibilities if you distribute copies of the software, or if you modify it: responsibilities to respect the freedom of others.

For example, if you distribute copies of such a program, whether gratis or for a fee, you must pass on to the recipients the same freedoms that you received. You must make sure that they, too, receive or can get the source code. And you must show them these terms so they know their rights.

Developers that use the GNU GPL protect your rights with two steps:

(1) assert copyright on the software, and (2) offer you this License giving you legal permission to copy, distribute and/or modify it.

For the developers' and authors' protection, the GPL clearly explains that there is no warranty for this free software. For both users' and authors' sake, the GPL requires that modified versions be marked as changed, so that their problems will not be attributed erroneously to authors of previous versions.

Some devices are designed to deny users access to install or run modified versions of the software inside them, although the manufacturer can do so. This is fundamentally incompatible with the aim of protecting users' freedom to change the software. The systematic pattern of such abuse occurs in the area of products for individuals to use, which is precisely where it is most unacceptable. Therefore, we have designed this version of the GPL to prohibit the practice for those products. If such problems arise substantially in other domains, we stand ready to extend this provision to those domains in future versions of the GPL, as needed to protect the freedom of users.

Finally, every program is threatened constantly by software patents. States should not allow patents to restrict development and use of software on general-purpose computers, but in those that do, we wish to

avoid the special danger that patents applied to a free program could make it effectively proprietary. To prevent this, the GPL assures that patents cannot be used to render the program non-free.

The precise terms and conditions for copying, distribution and modification follow.

#### TERMS AND CONDITIONS

##### 0. Definitions.

"This License" refers to version 3 of the GNU General Public License.

"Copyright" also means copyright-like laws that apply to other kinds of works, such as semiconductor masks.

"The Program" refers to any copyrightable work licensed under this License. Each licensee is addressed as "you".

"Licensees" and "recipients" may be individuals or organizations.



To “modify” a work means to copy from or adapt all or part of the work in a fashion requiring copyright permission, other than the making of an exact copy. The resulting work is called a “modified version” of the earlier work or a work “based on” the earlier work.

A “covered work” means either the unmodified Program or a work based on the Program.

To “propagate” a work means to do anything with it that, without permission, would make you directly or secondarily liable for infringement under applicable copyright law, except executing it on a computer or modifying a private copy. Propagation includes copying, distribution (with or without modification), making available to the public, and in some countries other activities as well.

To “convey” a work means any kind of propagation that enables other parties to make or receive copies. Mere interaction with a user through a computer network, with no transfer of a copy, is not conveying.

An interactive user interface displays “Appropriate Legal Notices” to the extent that it includes a convenient and prominently visible feature that (1) displays an appropriate copyright notice, and (2) tells the user that there is no warranty for the work (except to the extent that warranties are provided), that licensees may convey the work under this License, and how to view a copy of this License. If the interface presents a list of user commands or options, such as a menu, a prominent item in the list meets this criterion.

## 1. Source Code.

The “source code” for a work means the preferred form of the work for making modifications to it. “Object code” means any non-source form of a work.

A “Standard Interface” means an interface that either is an official standard defined by a recognized standards body, or, in the case of interfaces specified for a particular programming language, one that is widely used among developers working in that language.

The “System Libraries” of an executable work include anything, other than the work as a whole, that (a) is included in the normal form of packaging a Major Component, but which is not part of that Major Component, and (b) serves only to enable use of the work with that Major Component, or to implement a Standard Interface for which an implementation is available to the public in source code form. A “Major Component”, in this context, means a major essential component (kernel, window system, and so on) of the specific operating system (if any) on which the executable work runs, or a compiler used to produce the work, or an object code interpreter used to run it.

The “Corresponding Source” for a work in object code form means all the source code needed to generate, install, and (for an executable work) run the object code and to modify the work, including scripts to control those activities. However, it does not include the work’s System Libraries, or general-purpose tools or generally available free programs which are used unmodified in performing those activities but which are not part of the work. For example, Corresponding Source includes interface definition files associated with source files for the work, and the source code for shared libraries and dynamically linked subprograms that the work is specifically designed to require, such as by intimate data communication or control flow between those subprograms and other parts of the work.

The Corresponding Source need not include anything that users can regenerate automatically from other parts of the Corresponding Source.

The Corresponding Source for a work in source code form is that same work.

## 2. Basic Permissions.

All rights granted under this License are granted for the term of copyright on the Program, and are irrevocable provided the stated conditions are met. This License explicitly affirms your unlimited permission to run the unmodified Program. The output from running a covered work is covered by this License only if the output, given its content, constitutes a covered work. This License acknowledges your rights of fair use or other equivalent, as provided by copyright law.

You may make, run and propagate covered works that you do not convey, without conditions so long as your license otherwise remains in force. You may convey covered works to others for the sole purpose of having them make modifications exclusively for you, or provide you with facilities for running those works, provided that you comply with the terms of this License in conveying all material for which you do not control copyright. Those thus making or running the covered works for you must do so exclusively on your behalf, under your direction and control, on terms that prohibit them from making any copies of your copyrighted material outside their relationship with you.

Conveying under any other circumstances is permitted solely under the conditions stated below. Sublicensing is not allowed; section 10 makes it unnecessary.

### 3. Protecting Users' Legal Rights From Anti-Circumvention Law.

No covered work shall be deemed part of an effective technological measure under any applicable law fulfilling obligations under article 11 of the WIPO copyright treaty adopted on 20 December 1996, or similar laws prohibiting or restricting circumvention of such measures.

When you convey a covered work, you waive any legal power to forbid circumvention of technological measures to the extent such circumvention is effected by exercising rights under this License with respect to the covered work, and you disclaim any intention to limit operation or modification of the work as a means of enforcing, against the work's users, your or third parties' legal rights to forbid circumvention of technological measures.

### 4. Conveying Verbatim Copies.

You may convey verbatim copies of the Program's source code as you receive it, in any medium, provided that you conspicuously and appropriately publish on each copy an appropriate copyright notice; keep intact all notices stating that this License and any non-permissive terms added in accord with section 7 apply to the code; keep intact all notices of the absence of any warranty; and give all recipients a copy of this License along with the Program.

You may charge any price or no price for each copy that you convey, and you may offer support or warranty protection for a fee.

### 5. Conveying Modified Source Versions.

You may convey a work based on the Program, or the modifications to produce it from the Program, in the form of source code under the terms of section 4, provided that you also meet all of these conditions:

- a) The work must carry prominent notices stating that you modified it, and giving a relevant date.
- b) The work must carry prominent notices stating that it is released under this License and any conditions added under section 7. This requirement modifies the requirement in section 4 to "keep intact all notices".
- c) You must license the entire work, as a whole, under this License to anyone who comes into possession of a copy. This License will therefore apply, along with any applicable section 7 additional terms, to the whole of the work, and all its parts, regardless of how they are packaged. This License gives no permission to license the work in any other way, but it does not invalidate such permission if you have separately received it.
- d) If the work has interactive user interfaces, each must display Appropriate Legal Notices; however, if the Program has interactive interfaces that do not display Appropriate Legal Notices, your work need not make them do so.

A compilation of a covered work with other separate and independent works, which are not by their nature extensions of the covered work, and which are not combined with it such as to form a larger program, in or on a volume of a storage or distribution medium, is called an "aggregate" if the compilation and its resulting copyright are not used to limit the access or legal rights of the compilation's users beyond what the individual works permit. Inclusion of a covered work in an aggregate does not cause this License to apply to the other parts of the aggregate.





## 6. Conveying Non-Source Forms.

You may convey a covered work in object code form under the terms of sections 4 and 5, provided that you also convey the machine-readable Corresponding Source under the terms of this License, in one of these ways:

- a) Convey the object code in, or embodied in, a physical product (including a physical distribution medium), accompanied by the Corresponding Source fixed on a durable physical medium customarily used for software interchange.
- b) Convey the object code in, or embodied in, a physical product (including a physical distribution medium), accompanied by a written offer, valid for at least three years and valid for as long as you offer spare parts or customer support for that product model, to give anyone who possesses the object code either (1) a copy of the Corresponding Source for all the software in the product that is covered by this License, on a durable physical medium customarily used for software interchange, for a price no more than your reasonable cost of physically performing this conveying of source, or (2) access to copy the Corresponding Source from a network server at no charge.
- c) Convey individual copies of the object code with a copy of the written offer to provide the Corresponding Source. This alternative is allowed only occasionally and noncommercially, and only if you received the object code with such an offer, in accord with subsection 6b.
- d) Convey the object code by offering access from a designated place (gratis or for a charge), and offer equivalent access to the Corresponding Source in the same way through the same place at no further charge. You need not require recipients to copy the Corresponding Source along with the object code. If the place to copy the object code is a network server, the Corresponding Source may be on a different server (operated by you or a third party) that supports equivalent copying facilities, provided you maintain clear directions next to the object code saying where to find the Corresponding Source. Regardless of what server hosts the Corresponding Source, you remain obligated to ensure that it is available for as long as needed to satisfy these requirements.
- e) Convey the object code using peer-to-peer transmission, provided you inform other peers where the object code and Corresponding Source of the work are being offered to the general public at no charge under subsection 6d.

A separable portion of the object code, whose source code is excluded from the Corresponding Source as a System Library, need not be included in conveying the object code work.

A “User Product” is either (1) a “consumer product”, which means any tangible personal property which is normally used for personal, family, or household purposes, or (2) anything designed or sold for incorporation

into a dwelling. In determining whether a product is a consumer product, doubtful cases shall be resolved in favor of coverage. For a particular product received by a particular user, “normally used” refers to a

typical or common use of that class of product, regardless of the status of the particular user or of the way in which the particular user actually uses, or expects or is expected to use, the product. A product is a consumer product regardless of whether the product has substantial commercial, industrial or non-consumer uses, unless such uses represent the only significant mode of use of the product.

“Installation Information” for a User Product means any methods, procedures, authorization keys, or other information required to install and execute modified versions of a covered work in that User Product from a modified version of its Corresponding Source. The information must suffice to ensure that the continued functioning of the modified object code is in no case prevented or interfered with solely because

modification has been made.

If you convey an object code work under this section in, or with, or specifically for use in, a User Product, and the conveying occurs as part of a transaction in which the right of possession and use of the User Product is transferred to the recipient in perpetuity or for a fixed term (regardless of how the transaction is characterized), the Corresponding Source conveyed under this section must be accompanied by the Installation Information. But this requirement does not apply if neither you nor any third party retains the ability to install modified object code on the User Product (for example, the work has been installed in ROM).

The requirement to provide Installation Information does not include a requirement to continue to provide support service, warranty, or updates for a work that has been modified or installed by the recipient, or for

the User Product in which it has been modified or installed. Access to a network may be denied when the modification itself materially and adversely affects the operation of the network or violates the rules and protocols for communication across the network.

Corresponding Source conveyed, and Installation Information provided, in accord with this section must be in a format that is publicly documented (and with an implementation available to the public in source code form), and must require no special password or key for unpacking, reading or copying.

## 7. Additional Terms.

“Additional permissions” are terms that supplement the terms of this License by making exceptions from one or more of its conditions. Additional permissions that are applicable to the entire Program shall be treated as though they were included in this License, to the extent that they are valid under applicable law. If additional permissions apply only to part of the Program, that part may be used separately under those permissions, but the entire Program remains governed by this License without regard to the additional permissions.

When you convey a copy of a covered work, you may at your option remove any additional permissions from that copy, or from any part of it. (Additional permissions may be written to require their own removal in certain cases when you modify the work.) You may place additional permissions on material, added by you to a covered work, for which you have or can give appropriate copyright permission.

Notwithstanding any other provision of this License, for material you add to a covered work, you may (if authorized by the copyright holders of that material) supplement the terms of this License with terms:

- a) Disclaiming warranty or limiting liability differently from the terms of sections 15 and 16 of this License; or
- b) Requiring preservation of specified reasonable legal notices or author attributions in that material or in the Appropriate Legal Notices displayed by works containing it; or
- c) Prohibiting misrepresentation of the origin of that material, or requiring that modified versions of such material be marked in reasonable ways as different from the original version; or
- d) Limiting the use for publicity purposes of names of licensors or authors of the material; or
- e) Declining to grant rights under trademark law for use of some trade names, trademarks, or service marks; or
- f) Requiring indemnification of licensors and authors of that material by anyone who conveys the material (or modified versions of it) with contractual assumptions of liability to the recipient, for any liability that these contractual assumptions directly impose on those licensors and authors.

All other non-permissive additional terms are considered “further restrictions” within the meaning of section 10. If the Program as you received it, or any part of it, contains a notice stating that it is governed by this License along with a term that is a further restriction, you may remove that term. If a license document contains a further restriction but permits relicensing or conveying under this License, you may add to a covered work material governed by the terms of that license document, provided that the further restriction does not survive such relicensing or conveying.

If you add terms to a covered work in accord with this section, you must place, in the relevant source files, a statement of the additional terms that apply to those files, or a notice indicating where to find the applicable terms.

Additional terms, permissive or non-permissive, may be stated in the form of a separately written license, or stated as exceptions; the above requirements apply either way.

## 8. Termination.

You may not propagate or modify a covered work except as expressly provided under this License. Any attempt otherwise to propagate or modify it is void, and will automatically terminate your rights under this License (including any patent licenses granted under the third paragraph of section 11).

However, if you cease all violation of this License, then your license from a particular copyright holder is reinstated (a) provisionally, unless and until the copyright holder explicitly and finally terminates your license, and (b) permanently, if the copyright holder fails to notify you of the violation by some reasonable means prior to 60 days after the cessation.

Moreover, your license from a particular copyright holder is reinstated permanently if the copyright holder notifies you of the violation by some reasonable means, this is the first time you have received notice of violation of this License (for any work) from that copyright holder, and you cure the violation prior to 30 days after your receipt of the notice.

Termination of your rights under this section does not terminate the licenses of parties who have received copies or rights from you under this License. If your rights have been terminated and not permanently reinstated, you do not qualify to receive new licenses for the same material under section 10.

#### 9. Acceptance Not Required for Having Copies.

You are not required to accept this License in order to receive or run a copy of the Program. Ancillary propagation of a covered work occurring solely as a consequence of using peer-to-peer transmission to receive a copy likewise does not require acceptance. However, nothing other than this License grants you permission to propagate or modify any covered work. These actions infringe copyright if you do not accept this License. Therefore, by modifying or propagating a covered work, you indicate your acceptance of this License to do so.

#### 10. Automatic Licensing of Downstream Recipients.

Each time you convey a covered work, the recipient automatically receives a license from the original licensors, to run, modify and propagate that work, subject to this License. You are not responsible for enforcing compliance by third parties with this License.

An “entity transaction” is a transaction transferring control of an organization, or substantially all assets of one, or subdividing an organization, or merging organizations. If propagation of a covered work results from an entity transaction, each party to that transaction who receives a copy of the work also receives whatever licenses to the work the party’s predecessor in interest had or could give under the previous paragraph, plus a right to possession of the Corresponding Source of the work from the predecessor in interest, if the predecessor has it or can get it with reasonable efforts.

You may not impose any further restrictions on the exercise of the rights granted or affirmed under this License. For example, you may not impose a license fee, royalty, or other charge for exercise of rights granted under this License, and you may not initiate litigation (including a cross-claim or counterclaim in a lawsuit) alleging that any patent claim is infringed by making, using, selling, offering for sale, or importing the Program or any portion of it.

#### 11. Patents.

A “contributor” is a copyright holder who authorizes use under this License of the Program or a work on which the Program is based. The work thus licensed is called the contributor’s “contributor version”.

A contributor’s “essential patent claims” are all patent claims owned or controlled by the contributor, whether already acquired or hereafter acquired, that would be infringed by some manner, permitted by this License, of making, using, or selling its contributor version, but do not include claims that would be infringed only as a consequence of further modification of the contributor version. For purposes of this definition, “control” includes the right to grant patent sublicenses in a manner consistent with the requirements of this License.

Each contributor grants you a non-exclusive, worldwide, royalty-free patent license under the contributor’s essential patent claims, to make, use, sell, offer for sale, import and otherwise run, modify and propagate the contents of its contributor version.

In the following three paragraphs, a “patent license” is any express agreement or commitment, however denominated, not to enforce a patent (such as an express permission to practice a patent or covenant not to sue for patent infringement). To “grant” such a patent license to a party means to make such an agreement or commitment not to enforce a patent against the party.

If you convey a covered work, knowingly relying on a patent license, and the Corresponding Source of the work is not available for anyone to copy, free of charge and under the terms of this License, through a publicly available network server or other readily accessible means, then you must either (1) cause the Corresponding Source to be so available, or (2) arrange to deprive yourself of the benefit of the patent license for this particular work, or (3) arrange, in a manner consistent with the requirements of this License, to extend the patent license to downstream recipients. “Knowingly relying” means you have actual knowledge that, but for the patent license, your conveying the covered work in a country, or your recipient’s use of the covered work in a country, would infringe one or more identifiable patents in that country that you have reason to believe are valid.

If, pursuant to or in connection with a single transaction or arrangement, you convey, or propagate by procuring conveyance of, a covered work, and grant a patent license to some of the parties receiving the covered work authorizing them to use, propagate, modify or convey a specific copy of the covered work, then the patent license you grant is automatically extended to all recipients of the covered work and works based on it.

A patent license is “discriminatory” if it does not include within the scope of its coverage, prohibits the exercise of, or is conditioned on the non-exercise of one or more of the rights that are specifically granted under this License. You may not convey a covered work if you are a party to an arrangement with a third party that is in the business of distributing software, under which you make payment to the third party based on the extent of your activity of conveying the work, and under which the third party grants, to any of the parties who would receive the covered work from you, a discriminatory patent license (a) in connection with copies of the covered work conveyed by you (or copies made from those copies), or (b) primarily for and in connection with specific products or compilations that contain the covered work, unless you entered into that arrangement, or that patent license was granted, prior to 28 March 2007.

Nothing in this License shall be construed as excluding or limiting any implied license or other defenses to infringement that may otherwise be available to you under applicable patent law.

#### 12. No Surrender of Others’ Freedom.

If conditions are imposed on you (whether by court order, agreement or otherwise) that contradict the conditions of this License, they do not excuse you from the conditions of this License. If you cannot convey a covered work so as to satisfy simultaneously your obligations under this License and any other pertinent obligations, then as a consequence you may not convey it at all. For example, if you agree to terms that obligate you to collect a royalty for further conveying from those to whom you convey the Program, the only way you could satisfy both those terms and this License would be to refrain entirely from conveying the Program.

#### 13. Use with the GNU Affero General Public License.

Notwithstanding any other provision of this License, you have permission to link or combine any covered work with a work licensed under version 3 of the GNU Affero General Public License into a single combined work, and to convey the resulting work. The terms of this License will continue to apply to the part which is the covered work, but the special requirements of the GNU Affero General Public License, section 13, concerning interaction through a network will apply to the combination as such.

#### 14. Revised Versions of this License.

The Free Software Foundation may publish revised and/or new versions of the GNU General Public License from time to time. Such new versions will be similar in spirit to the present version, but may differ in detail to address new problems or concerns.

Each version is given a distinguishing version number. If the Program specifies that a certain numbered version of the GNU General Public License “or any later version” applies to it, you have the option of following the terms and conditions either of that numbered version or of any later version published by the Free Software Foundation. If the Program does not specify a version number of the GNU General Public License, you may choose any version ever published by the Free Software Foundation.



If the Program specifies that a proxy can decide which future versions of the GNU General Public License can be used, that proxy's public statement of acceptance of a version permanently authorizes you to choose that version for the Program.

Later license versions may give you additional or different permissions. However, no additional obligations are imposed on any author or copyright holder as a result of your choosing to follow a later version.

#### 15. Disclaimer of Warranty.

THERE IS NO WARRANTY FOR THE PROGRAM, TO THE EXTENT PERMITTED BY APPLICABLE LAW. EXCEPT WHEN OTHERWISE STATED IN WRITING THE COPYRIGHT HOLDERS AND/OR OTHER PARTIES PROVIDE THE PROGRAM "AS IS" WITHOUT WARRANTY OF ANY KIND, EITHER EXPRESSED OR IMPLIED, INCLUDING, BUT NOT LIMITED TO, THE IMPLIED WARRANTIES OF MERCHANTABILITY AND FITNESS FOR A PARTICULAR PURPOSE. THE ENTIRE RISK AS TO THE QUALITY AND PERFORMANCE OF THE PROGRAM IS WITH YOU. SHOULD THE PROGRAM PROVE DEFECTIVE, YOU ASSUME THE COST OF ALL NECESSARY SERVICING, REPAIR OR CORRECTION.

#### 16. Limitation of Liability.

IN NO EVENT UNLESS REQUIRED BY APPLICABLE LAW OR AGREED TO IN WRITING WILL ANY COPYRIGHT HOLDER, OR ANY OTHER PARTY WHO MODIFIES AND/OR CONVEYS THE PROGRAM AS PERMITTED ABOVE, BE LIABLE TO YOU FOR DAMAGES, INCLUDING ANY GENERAL, SPECIAL, INCIDENTAL OR CONSEQUENTIAL DAMAGES ARISING OUT OF THE USE OR INABILITY TO USE THE PROGRAM (INCLUDING BUT NOT LIMITED TO LOSS OF DATA OR DATA BEING RENDERED INACCURATE OR LOSSES SUSTAINED BY YOU OR THIRD PARTIES OR A FAILURE OF THE PROGRAM TO OPERATE WITH ANY OTHER PROGRAMS), EVEN IF SUCH HOLDER OR OTHER PARTY HAS BEEN ADVISED OF THE POSSIBILITY OF SUCH DAMAGES.

#### 17. Interpretation of Sections 15 and 16.

If the disclaimer of warranty and limitation of liability provided above cannot be given local legal effect according to their terms, reviewing courts shall apply local law that most closely approximates an absolute waiver of all civil liability in connection with the Program, unless a warranty or assumption of liability accompanies a copy of the Program in return for a fee.

### END OF TERMS AND CONDITIONS

#### How to Apply These Terms to Your New Programs

If you develop a new program, and you want it to be of the greatest possible use to the public, the best way to achieve this is to make it free software which everyone can redistribute and change under these terms.

To do so, attach the following notices to the program. It is safest to attach them to the start of each source file to most effectively state the exclusion of warranty; and each file should have at least the "copyright" line and a pointer to where the full notice is found.

<one line to give the program's name and a brief idea of what it does.>

Copyright (C) <year> <name of author>



This program is free software: you can redistribute it and/or modify it under the terms of the GNU General Public License as published by the Free Software Foundation, either version 3 of the License, or(at your option) any later version.

This program is distributed in the hope that it will be useful, but WITHOUT ANY WARRANTY; without even the implied warranty of MERCHANTABILITY or FITNESS FOR A PARTICULAR PURPOSE. See the GNU General Public License for more details.

You should have received a copy of the GNU General Public License along with this program. If not, see <<http://www.gnu.org/licenses/>>.

Also add information on how to contact you by electronic and paper mail.

If the program does terminal interaction, make it output a short notice like this when it starts in an interactive mode:

```
<program> Copyright (C) <year> <name of author>
```

```
This program comes with ABSOLUTELY NO WARRANTY; for details type `show w'.
```

```
This is free software, and you are welcome to redistribute it under certain conditions; type `show c' for details.
```

The hypothetical commands `show w' and `show c' should show the appropriate parts of the General Public License. Of course, your program's commands might be different; for a GUI interface, you would use an "about box".

You should also get your employer (if you work as a programmer) or school, if any, to sign a "copyright disclaimer" for the program, if necessary. For more information on this, and how to apply and follow the GNU GPL, see <<http://www.gnu.org/licenses/>>.

The GNU General Public License does not permit incorporating your program into proprietary programs. If your program is a subroutine library, you may consider it more useful to permit linking proprietary applications with the library. If this is what you want to do, use the GNU Lesser General Public License instead of this License. But first, please read <<http://www.gnu.org/philosophy/why-not-lgpl.html>>.

## 9.2 GNU LESSER GENERAL PUBLIC LICENSE

### GNU LESSER GENERAL PUBLIC LICENSE

Version 3, 29 June 2007

Copyright (C) 2007 Free Software Foundation, Inc. <<http://fsf.org/>>

Everyone is permitted to copy and distribute verbatim copies of this license document, but changing it is not allowed.

This version of the GNU Lesser General Public License incorporates the terms and conditions of version 3 of the GNU General Public License, supplemented by the additional permissions listed below.

As used herein, “this License” refers to version 3 of the GNU Lesser General Public License, and the “GNU GPL” refers to version 3 of the GNU General Public License.

“The Library” refers to a covered work governed by this License, other than an Application or a Combined Work as defined below.

An “Application” is any work that makes use of an interface provided by the Library, but which is not otherwise based on the Library. Defining a subclass of a class defined by the Library is deemed a mode of using an interface provided by the Library.

A “Combined Work” is a work produced by combining or linking an Application with the Library. The particular version of the Library with which the Combined Work was made is also called the “Linked Version”.

The “Minimal Corresponding Source” for a Combined Work means the Corresponding Source for the Combined Work, excluding any source code for portions of the Combined Work that, considered in isolation, are based on the Application, and not on the Linked Version.

The “Corresponding Application Code” for a Combined Work means the object code and/or source code for the Application, including any data and utility programs needed for reproducing the Combined Work from the Application, but excluding the System Libraries of the Combined Work.

#### 1. Exception to Section 3 of the GNU GPL.

You may convey a covered work under sections 3 and 4 of this License without being bound by section 3 of the GNU GPL.

#### 2. Conveying Modified Versions.

If you modify a copy of the Library, and, in your modifications, a facility refers to a function or data to be supplied by an Application that uses the facility (other than as an argument passed when the facility is invoked), then you may convey a copy of the modified version:

- a) under this License, provided that you make a good faith effort to ensure that, in the event an Application does not supply the function or data, the facility still operates, and performs whatever part of its purpose remains meaningful, or
- b) under the GNU GPL, with none of the additional permissions of this License applicable to that copy.

#### 3. Object Code Incorporating Material from Library Header Files.

The object code form of an Application may incorporate material from a header file that is part of the Library. You may convey such object code under terms of your choice, provided that, if the incorporated material is not limited to numerical parameters, data structure layouts and accessors, or small macros, inline functions and templates (ten or fewer lines in length), you do both of the following:

- a) Give prominent notice with each copy of the object code that the Library is used in it and that the Library and its use are covered by this License.
- b) Accompany the object code with a copy of the GNU GPL and this license document.

#### 4. Combined Works.

You may convey a Combined Work under terms of your choice that, taken together, effectively do not restrict modification of the portions of the Library contained in the Combined Work and reverse engineering for debugging such modifications, if you also do each of the following:

- a) Give prominent notice with each copy of the Combined Work that the Library is used in it and that the Library and its use are covered by this License.
- b) Accompany the Combined Work with a copy of the GNU GPL and this license document.

- c) For a Combined Work that displays copyright notices during execution, include the copyright notice for the Library among these notices, as well as a reference directing the user to the copies of the GNU GPL and this license document.
- d) Do one of the following:
  - 0) Convey the Minimal Corresponding Source under the terms of this License, and the Corresponding Application Code in a form suitable for, and under terms that permit, the user to recombine or relink the Application with a modified version of the Linked Version to produce a modified Combined Work, in the manner specified by section 6 of the GNU GPL for conveying Corresponding Source.
  - 0) Use a suitable shared library mechanism for linking with the Library. A suitable mechanism is one that (a) uses at run time a copy of the Library already present on the user's computer system, and (b) will operate properly with a modified version of the Library that is interface-compatible with the Linked Version.
- e) Provide Installation Information, but only if you would otherwise be required to provide such information under section 6 of the GNU GPL, and only to the extent that such information is necessary to install and execute a modified version of the Combined Work produced by recombining or relinking the Application with a modified version of the Linked Version. (If you use option 4d0, the Installation Information must accompany the Minimal Corresponding Source and Corresponding Application Code. If you use option 4d1, you must provide the Installation Information in the manner specified by section 6 of the GNU GPL for conveying Corresponding Source.)

## 5. Combined Libraries.

You may place library facilities that are a work based on the Library side by side in a single library together with other library facilities that are not Applications and are not covered by this License, and convey such a combined library under terms of your choice, if you do both of the following:

- a) Accompany the combined library with a copy of the same work based on the Library, uncombined with any other library facilities, conveyed under the terms of this License.
- b) Give prominent notice with the combined library that part of it is a work based on the Library, and explaining where to find the accompanying uncombined form of the same work.

## 6. Revised Versions of the GNU Lesser General Public License.

The Free Software Foundation may publish revised and/or new versions of the GNU Lesser General Public License from time to time. Such new versions will be similar in spirit to the present version, but may differ in detail to address new problems or concerns.

Each version is given a distinguishing version number. If the Library as you received it specifies that a certain numbered version of the GNU Lesser General Public License "or any later version" applies to it, you have the option of following the terms and conditions either of that published version or of any later version published by the Free Software Foundation. If the Library as you received it does not specify a version number of the GNU Lesser General Public License, you may choose any version of the GNU Lesser General Public License ever published by the Free Software Foundation.

# 9

If the Library as you received it specifies that a proxy can decide whether future versions of the GNU Lesser General Public License shall apply, that proxy's public statement of acceptance of any version is permanent authorization for you to choose that version for the Library.



## 9.3 NET-SNMP

Various copyrights apply to this package, listed in various separate parts below. Please make sure that you read all the parts.

---- Part 1: CMU/UCD copyright notice: (BSD like) ----

Copyright 1989, 1991, 1992 by Carnegie Mellon University

Derivative Work - 1996, 1998-2000

Copyright 1996, 1998-2000 The Regents of the University of California

All Rights Reserved

Permission to use, copy, modify and distribute this software and its documentation for any purpose and without fee is hereby granted, provided that the above copyright notice appears in all copies and that both that copyright notice and this permission notice appear in supporting documentation, and that the name of CMU and The Regents of the University of California not be used in advertising or publicity pertaining to distribution of the software without specific written permission.

CMU AND THE REGENTS OF THE UNIVERSITY OF CALIFORNIA DISCLAIM ALL WARRANTIES WITH REGARD TO THIS SOFTWARE, INCLUDING ALL IMPLIED WARRANTIES OF MERCHANTABILITY AND FITNESS. IN NO EVENT SHALL CMU OR THE REGENTS OF THE UNIVERSITY OF CALIFORNIA BE LIABLE FOR ANY SPECIAL, INDIRECT OR CONSEQUENTIAL DAMAGES OR ANY DAMAGES WHATSOEVER RESULTING FROM THE LOSS OF USE, DATA OR PROFITS, WHETHER IN AN ACTION OF CONTRACT, NEGLIGENCE OR OTHER TORTIOUS ACTION, ARISING OUT OF OR IN CONNECTION WITH THE USE OR PERFORMANCE OF THIS SOFTWARE.

---- Part 2: Networks Associates Technology, Inc copyright notice (BSD) ----

Copyright (c) 2001-2003, Networks Associates Technology, Inc

All rights reserved.

Redistribution and use in source and binary forms, with or without modification, are permitted provided that the following conditions are met:

- \* Redistributions of source code must retain the above copyright notice, this list of conditions and the following disclaimer.
- \* Redistributions in binary form must reproduce the above copyright notice, this list of conditions and the following disclaimer in the documentation and/or other materials provided with the distribution.
- \* Neither the name of the Networks Associates Technology, Inc nor the names of its contributors may be used to endorse or promote products derived from this software without specific prior written permission.

THIS SOFTWARE IS PROVIDED BY THE COPYRIGHT HOLDERS AND CONTRIBUTORS ``AS IS'' AND ANY EXPRESS OR IMPLIED WARRANTIES, INCLUDING, BUT NOT LIMITED TO, THE IMPLIED WARRANTIES OF MERCHANTABILITY AND FITNESS FOR A PARTICULAR PURPOSE ARE DISCLAIMED. IN NO EVENT SHALL THE COPYRIGHT HOLDERS OR CONTRIBUTORS BE LIABLE FOR ANY DIRECT, INDIRECT, INCIDENTAL, SPECIAL, EXEMPLARY, OR CONSEQUENTIAL DAMAGES (INCLUDING, BUT NOT LIMITED TO, PROCUREMENT OF SUBSTITUTE GOODS OR SERVICES; LOSS OF USE, DATA, OR PROFITS; OR BUSINESS INTERRUPTION) HOWEVER CAUSED AND ON ANY THEORY OF LIABILITY, WHETHER IN CONTRACT, STRICT LIABILITY, OR TORT (INCLUDING NEGLIGENCE OR OTHERWISE) ARISING IN ANY WAY OUT OF THE USE OF THIS SOFTWARE, EVEN IF ADVISED OF THE POSSIBILITY OF SUCH DAMAGE.

---- Part 3: Cambridge Broadband Ltd. copyright notice (BSD) ----

Portions of this code are copyright (c) 2001-2003, Cambridge Broadband Ltd.

All rights reserved.

Redistribution and use in source and binary forms, with or without modification, are permitted provided that the following conditions are met:

- \* Redistributions of source code must retain the above copyright notice, this list of conditions and the following disclaimer.
- \* Redistributions in binary form must reproduce the above copyright notice, this list of conditions and the following disclaimer in the documentation and/or other materials provided with the distribution.

\* The name of Cambridge Broadband Ltd. may not be used to endorse or promote products derived from this software without specific prior written permission.

THIS SOFTWARE IS PROVIDED BY THE COPYRIGHT HOLDER ``AS IS'' AND ANY EXPRESS OR IMPLIED WARRANTIES, INCLUDING, BUT NOT LIMITED TO, THE IMPLIED WARRANTIES OF MERCHANTABILITY AND FITNESS FOR A PARTICULAR PURPOSE ARE DISCLAIMED. IN NO EVENT SHALL THE COPYRIGHT HOLDER BE LIABLE FOR ANY DIRECT, INDIRECT, INCIDENTAL, SPECIAL, EXEMPLARY, OR CONSEQUENTIAL DAMAGES (INCLUDING, BUT NOT LIMITED TO, PROCUREMENT OF SUBSTITUTE GOODS OR SERVICES; LOSS OF USE, DATA, OR PROFITS; OR BUSINESS INTERRUPTION) HOWEVER CAUSED AND ON ANY THEORY OF LIABILITY, WHETHER IN CONTRACT, STRICT LIABILITY, OR TORT (INCLUDING NEGLIGENCE OR OTHERWISE) ARISING IN ANY WAY OUT OF THE USE OF THIS SOFTWARE, EVEN IF ADVISED OF THE POSSIBILITY OF SUCH DAMAGE.

---- Part 4: Sun Microsystems, Inc. copyright notice (BSD) ----

Copyright <A9> 2003 Sun Microsystems, Inc., 4150 Network Circle, Santa Clara, California 95054, U.S.A. All rights reserved.

Use is subject to license terms below.

This distribution may include materials developed by third parties.

Sun, Sun Microsystems, the Sun logo and Solaris are trademarks or registered trademarks of Sun Microsystems, Inc. in the U.S. and other countries.

Redistribution and use in source and binary forms, with or without modification, are permitted provided that the following conditions are met:

Redistributions of source code must retain the above copyright notice, this list of conditions and the following disclaimer.

Redistributions in binary form must reproduce the above copyright notice, this list of conditions and the following disclaimer in the documentation and/or other materials provided with the distribution.

Neither the name of the Sun Microsystems, Inc. nor the names of its contributors may be used to endorse or promote products derived from this software without specific prior written permission.

THIS SOFTWARE IS PROVIDED BY THE COPYRIGHT HOLDERS AND CONTRIBUTORS ``AS IS'' AND ANY EXPRESS OR IMPLIED WARRANTIES, INCLUDING, BUT NOT LIMITED TO, THE IMPLIED WARRANTIES OF MERCHANTABILITY AND FITNESS FOR A PARTICULAR PURPOSE ARE DISCLAIMED. IN NO EVENT SHALL THE COPYRIGHT HOLDERS OR CONTRIBUTORS BE LIABLE FOR ANY DIRECT, INDIRECT, INCIDENTAL, SPECIAL, EXEMPLARY, OR CONSEQUENTIAL DAMAGES (INCLUDING, BUT NOT LIMITED TO, PROCUREMENT OF SUBSTITUTE GOODS OR SERVICES; LOSS OF USE, DATA, OR PROFITS; OR BUSINESS INTERRUPTION) HOWEVER CAUSED AND ON ANY THEORY OF LIABILITY, WHETHER IN CONTRACT, STRICT LIABILITY, OR TORT (INCLUDING NEGLIGENCE OR OTHERWISE) ARISING IN ANY WAY OUT OF THE USE OF THIS SOFTWARE, EVEN IF ADVISED OF THE POSSIBILITY OF SUCH DAMAGE.

---- Part 5: Sparta, Inc copyright notice (BSD) ----

Copyright (c) 2003-2008, Sparta, Inc

All rights reserved.

Redistribution and use in source and binary forms, with or without modification, are permitted provided that the following conditions are met:

\* Redistributions of source code must retain the above copyright notice, this list of conditions and the following disclaimer.

\* Redistributions in binary form must reproduce the above copyright notice, this list of conditions and the following disclaimer in the documentation and/or other materials provided with the distribution.

\* Neither the name of Sparta, Inc nor the names of its contributors may be used to endorse or promote products derived from this software without specific prior written permission.



THIS SOFTWARE IS PROVIDED BY THE COPYRIGHT HOLDERS AND CONTRIBUTORS ``AS IS'' AND ANY EXPRESS OR IMPLIED WARRANTIES, INCLUDING, BUT NOT LIMITED TO, THE IMPLIED WARRANTIES OF MERCHANTABILITY AND FITNESS FOR A PARTICULAR PURPOSE ARE DISCLAIMED. IN NO EVENT SHALL THE COPYRIGHT HOLDERS OR CONTRIBUTORS BE LIABLE FOR ANY DIRECT, INDIRECT, INCIDENTAL, SPECIAL, EXEMPLARY, OR CONSEQUENTIAL DAMAGES (INCLUDING, BUT NOT LIMITED TO, PROCUREMENT OF SUBSTITUTE GOODS OR SERVICES; LOSS OF USE, DATA, OR PROFITS; OR BUSINESS INTERRUPTION) HOWEVER CAUSED AND ON ANY THEORY OF LIABILITY, WHETHER IN CONTRACT, STRICT LIABILITY, OR TORT (INCLUDING NEGLIGENCE OR OTHERWISE) ARISING IN ANY WAY OUT OF THE USE OF THIS SOFTWARE, EVEN IF ADVISED OF THE POSSIBILITY OF SUCH DAMAGE.

---- Part 6: Cisco/BUPTNIC copyright notice (BSD) ----

Copyright (c) 2004, Cisco, Inc and Information Network

Center of Beijing University of Posts and Telecommunications.

All rights reserved.

Redistribution and use in source and binary forms, with or without

modification, are permitted provided that the following conditions are met:

- \* Redistributions of source code must retain the above copyright notice, this list of conditions and the following disclaimer.
- \* Redistributions in binary form must reproduce the above copyright notice, this list of conditions and the following disclaimer in the documentation and/or other materials provided with the distribution.
- \* Neither the name of Cisco, Inc, Beijing University of Posts and Telecommunications, nor the names of their contributors may be used to endorse or promote products derived from this software without specific prior written permission.

THIS SOFTWARE IS PROVIDED BY THE COPYRIGHT HOLDERS AND CONTRIBUTORS ``AS IS'' AND ANY EXPRESS OR IMPLIED WARRANTIES, INCLUDING, BUT NOT LIMITED TO, THE IMPLIED WARRANTIES OF MERCHANTABILITY AND FITNESS FOR A PARTICULAR PURPOSE ARE DISCLAIMED. IN NO EVENT SHALL THE COPYRIGHT HOLDERS OR CONTRIBUTORS BE LIABLE FOR ANY DIRECT, INDIRECT, INCIDENTAL, SPECIAL, EXEMPLARY, OR CONSEQUENTIAL DAMAGES (INCLUDING, BUT NOT LIMITED TO, PROCUREMENT OF SUBSTITUTE GOODS OR SERVICES; LOSS OF USE, DATA, OR PROFITS; OR BUSINESS INTERRUPTION) HOWEVER CAUSED AND ON ANY THEORY OF LIABILITY, WHETHER IN CONTRACT, STRICT LIABILITY, OR TORT (INCLUDING NEGLIGENCE OR OTHERWISE) ARISING IN ANY WAY OUT OF THE USE OF THIS SOFTWARE, EVEN IF ADVISED OF THE POSSIBILITY OF SUCH DAMAGE.

---- Part 7: Fabasoft R&D Software GmbH & Co KG copyright notice (BSD) ----

Copyright (c) Fabasoft R&D Software GmbH & Co KG, 2003

oss@fabasoft.com

Author: Bernhard Penz <bernhard.penz@fabasoft.com>

Redistribution and use in source and binary forms, with or without modification, are permitted provided that the following conditions are met:

- \* Redistributions of source code must retain the above copyright notice, this list of conditions and the following disclaimer.
- \* Redistributions in binary form must reproduce the above copyright notice, this list of conditions and the following disclaimer in the documentation and/or other materials provided with the distribution.
- \* The name of Fabasoft R&D Software GmbH & Co KG or any of its subsidiaries, brand or product names may not be used to endorse or promote products derived from this software without specific prior written permission.

THIS SOFTWARE IS PROVIDED BY THE COPYRIGHT HOLDER ``AS IS'' AND ANY EXPRESS OR IMPLIED WARRANTIES, INCLUDING, BUT NOT LIMITED TO, THE IMPLIED WARRANTIES OF MERCHANTABILITY AND FITNESS FOR A PARTICULAR PURPOSE ARE DISCLAIMED. IN NO EVENT SHALL THE COPYRIGHT HOLDER BE LIABLE FOR ANY DIRECT, INDIRECT, INCIDENTAL, SPECIAL, EXEMPLARY, OR CONSEQUENTIAL DAMAGES (INCLUDING, BUT NOT LIMITED TO, PROCUREMENT OF SUBSTITUTE GOODS OR SERVICES; LOSS OF USE, DATA, OR PROFITS; OR BUSINESS INTERRUPTION) HOWEVER CAUSED AND ON ANY THEORY OF LIABILITY, WHETHER IN CONTRACT, STRICT LIABILITY, OR TORT (INCLUDING NEGLIGENCE OR OTHERWISE) ARISING IN ANY WAY OUT OF THE USE OF THIS SOFTWARE, EVEN IF ADVISED OF THE POSSIBILITY OF SUCH DAMAGE.

## 9.4 BSD LICENCE

Copyright (c) 1989 The Regents of the University of California.

All rights reserved.

This code is derived from software contributed to Berkeley by Mike Muuss.

Redistribution and use in source and binary forms, with or without modification, are permitted provided that the following conditions are met:

1. Redistributions of source code must retain the above copyright notice, this list of conditions and the following disclaimer.
2. Redistributions in binary form must reproduce the above copyright notice, this list of conditions and the following disclaimer in the documentation and/or other materials provided with the distribution.
3. All advertising materials mentioning features or use of this software must display the following acknowledgement:  
This product includes software developed by the University of California, Berkeley and its contributors.
4. Neither the name of the University nor the names of its contributors may be used to endorse or promote products derived from this software without specific prior written permission.

THIS SOFTWARE IS PROVIDED BY THE REGENTS AND CONTRIBUTORS ``AS IS'' AND ANY EXPRESS OR IMPLIED WARRANTIES, INCLUDING, BUT NOT LIMITED TO, THE IMPLIED WARRANTIES OF MERCHANTABILITY AND FITNESS FOR A PARTICULAR PURPOSE ARE DISCLAIMED. IN NO EVENT SHALL THE REGENTS OR CONTRIBUTORS BE LIABLE FOR ANY DIRECT, INDIRECT, INCIDENTAL, SPECIAL, EXEMPLARY, OR CONSEQUENTIAL DAMAGES (INCLUDING, BUT NOT LIMITED TO, PROCUREMENT OF SUBSTITUTE GOODS OR SERVICES; LOSS OF USE, DATA, OR PROFITS; OR BUSINESS INTERRUPTION) HOWEVER CAUSED AND ON ANY THEORY OF LIABILITY, WHETHER IN CONTRACT, STRICT LIABILITY, OR TORT (INCLUDING NEGLIGENCE OR OTHERWISE) ARISING IN ANY WAY OUT OF THE USE OF THIS SOFTWARE, EVEN IF ADVISED OF THE POSSIBILITY OF SUCH DAMAGE.

# ***PATLITE***®

## **PATLITE Corporation** G2J

<b>PATLITE Corporation</b> ※Head office	■ <a href="http://www.patlite.com/">www.patlite.com/</a>
<b>PATLITE (U.S.A.) Corporation</b>	■ <a href="http://www.patlite.com/">www.patlite.com/</a>
<b>PATLITE Europe GmbH</b> ※Germany	■ <a href="http://www.patlite.eu/">www.patlite.eu/</a>
<b>PATLITE (SINGAPORE) PTE LTD</b>	■ <a href="http://www.patlite-ap.com/">www.patlite-ap.com/</a>
<b>PATLITE (CHINA) Corporation</b>	■ <a href="http://www.patlite.cn/">www.patlite.cn/</a>
<b>PATLITE KOREA CO., LTD.</b>	■ <a href="http://www.patlite.co.kr/">www.patlite.co.kr/</a>
<b>PATLITE TAIWAN CO., LTD.</b>	■ <a href="http://www.patlite.tw/">www.patlite.tw/</a>
<b>PATLITE (THAILAND) CO., LTD.</b>	■ <a href="http://www.patlite.co.th/">www.patlite.co.th/</a>
<b>PATLITE MEXICO S.A. de C.V.</b>	■ <a href="http://www.patlite.com.mx/">www.patlite.com.mx/</a>

## **PATLITE Corporation**