

Signal Tower

LR



| | | | | | | | | |
|--------|---|------------------------------------|------------------------------|--|---|------------------------------------|--|-----------------------------|
| Φ40 mm | Φ50 mm | Φ60 mm | Φ70 mm | CE <small>(Excluding M2LJ type)</small> | RoHS 10 | UL | FCC | KC <small>(M2LJ)</small> |
| IP65 | IP54 <small>(LJ Type)</small> | NEMA TYPE 4X,13 | Indoor Use | Upright Mounting | Ambient Temperature -20°C~+45°C <small>(ABS & AS)</small> | Ambient Temperature -20°C~+50°C | Luminous Color Red, Amber, Green, Blue, White <small>Multi-color: 7 colors</small> | Continuous On |
| 60 fpm | Change Number of Tiers <small>(LR4, LR5)</small> | 85dB* <small>(LR4, LR5)</small> | 88dB <small>(LR6)</small> | 90dB <small>(LR7)</small> | 4 Alarm Sounds | | | |

*When using 12V DC: 80dB

Model Number Configuration

Φ40mm Model Code

LR4-502WJBW-RYGBCZ

Model ① ② ③ ④ ⑤ ⑥ ⑦

- | | | | | | | |
|---|---|--|---|--|--|--|
| ① Tiers 1 = 1 tier 2 = 2 tiers 3 = 3 tiers 4 = 4 tiers 5 = 5 tiers | ② Rated Voltage 02 = 24V DC M2 = 100-240V AC *1 | ③ Mounting/Wiring WJ = Direct Mount/Cable LJ = Pole Mount with L-bracket/Cable PJ = Pole Mount with Circular Bracket/Cable QJ = Pole Mount with Folding Bracket/Cable *2 | ④ Flashing/Buzzer B = With Flashing/Buzzer N = No Flashing/Buzzer | ⑤ Body Color W = Off-white U = Silver *3 | ⑥ Luminous Color R = Red Y = Amber G = Green B = Blue C = White | ⑦ Globe Type Blank = Colored Z = Clear |
|---|---|--|---|--|--|--|

*1 For WJ, LJ and PJ type only *2 For 24V DC and Off-white type only *3 For 24V DC type WJ, LJ and PJ type only

Φ50mm Model Code

LR5-502WJBW-RYGBCZ

Model ① ② ③ ④ ⑤ ⑥ ⑦

- | | | | | | | |
|---|---|---|---|-------------------------------|--|--|
| ① Tiers 1 = 1 tier 2 = 2 tiers 3 = 3 tiers 4 = 4 tiers 5 = 5 tiers | ② Rated Voltage 01 = 12V DC 02 = 24V DC | ③ Mounting/Wiring WJ = Direct Mount/Cable LJ = Pole Mount with L-bracket/Cable PJ = Pole Mount with Circular Bracket/Cable | ④ Flashing/Buzzer B = With Flashing/Buzzer N = No Flashing/Buzzer | ⑤ Body Color W = Off-white | ⑥ Luminous Color R = Red Y = Amber G = Green B = Blue C = White | ⑦ Globe Type Blank = Colored Z = Clear |
|---|---|---|---|-------------------------------|--|--|

Φ60mm Model Code

LR6-502WJBW-RYGBCZ

Model ① ② ③ ④ ⑤ ⑥ ⑦

- | | | | | | | |
|---|---|--|---|--|---|--|
| ① Tiers 1 = 1 tier 2 = 2 tiers 3 = 3 tiers 4 = 4 tiers 5 = 5 tiers | ② Rated Voltage 02 = 24V DC M2 = 100-240V AC *1 | ③ Mounting/Wiring WJ = Direct Mount/Cable LJ = Pole Mount with L-bracket/Cable PJ = Pole Mount with Circular Bracket/Cable QJ = Pole Mount with Folding Bracket/Cable *2 WC = Direct Mount/M12 Connector *2 | ④ Flashing/Buzzer B = With Flashing/Buzzer N = No Flashing/Buzzer | ⑤ Body Color W = Off-white U = Silver *3 | ⑥ Luminous Color R = Red Y = Amber G = Green B = Blue C = White M = Multi Color | ⑦ Globe Type Blank = Colored Z = Clear |
|---|---|--|---|--|---|--|

*1 For WJ, LJ and PJ type only *2 For 24V DC and Off-white type only *3 For 24V DC type WJ, LJ and PJ type only

Φ70mm Model Code

LR7-502WJBW-RYGBC

Model ① ② ③ ④ ⑤ ⑥

- | | | | | | |
|---|--------------------------------|--|---|-------------------------------|--|
| ① Tiers 1 = 1 tier 2 = 2 tiers 3 = 3 tiers 4 = 4 tiers 5 = 5 tiers | ② Rated Voltage 02 = 24V DC | ③ Mounting/Wiring WJ = Direct Mount/Cable | ④ Flashing/Buzzer B = With Flashing/Buzzer N = No Flashing/Buzzer | ⑤ Body Color W = Off-white | ⑥ Luminous Color R = Red Y = Amber G = Green B = Blue C = White |
|---|--------------------------------|--|---|-------------------------------|--|

LAN / USB / PoE / Wireless

Signal Tower

Beacons

Cube Tower

Audible Alarms and MP3 Voice Announciators

Hybrid Signaling Devices

LED Illumination

Optional Parts

Specification

| | |
|------------------------------|--|
| Supported Transistors | NPN/PNP (Excluding M2 type) |
| Alarm Sound | 4 patterns (switch by DIP switch) No.1: Intermittent sound (Pipipi) No.2: Continuous sound (pee) No.3: High and low tones No.4: Sweep sound (Hune) *It is possible to sound an alarm that turns on and off in 0.5 second cycles by shorting the buzzer and flashing common lines. |
| Volume control | Sound can be reduced by DIP switch |

Optional Parts

For details refer to P. 93 to P. 98

| Product Description | Model Number |
|------------------------------|--------------|
| Circular bracket | SZW-001W |
| Wall mounting bracket | SZK-002W/U/K |
| Wall mounting bracket | SZK-003W/U/K |
| Wall mounting bracket | SZK-004W |
| Circular multi-mount bracket | SZP-001W/U/K |
| 1/2" NPT bracket | SZP-090U |
| 1/2" NPT bracket | SZP-091U |

| Product Description | Model Number |
|-----------------------|--------------|
| Circular bracket | SZP-002U |
| Folding bracket | SZQ-001W |
| Circular bracket | SZP-003W/U/K |
| L-Bracket | SZL-001 |
| Wall mounting bracket | SZK-001U |





























Product List Pre-Assembled Models

Compatible with WD Wireless Data Acquisition products (page. 11 - 13)

| Model Number | WD Compatible | Size (mm) | Number of Tiers | Rated Voltage | Mounting | Alarm | Luminous Color | Clear Globe | Power Consumption | Mass |
|----------------------|---------------|-----------|-----------------|---------------|----------|-------|--------------------------------|-------------|-------------------|---------|
| LR4-102WJNW(U)-R/Y/G | | Φ40 | 1 | 24V DC | Direct | | Red/Amber/Green | | 1.3W | 0.205kg |
| LR4-202WJNW(U)-RY/RG | | Φ40 | 2 | 24V DC | Direct | | Red, Amber / Red, Green | | 2.6W | 0.24kg |
| LR4-302WJNW(U)-RYG | | Φ40 | 3 | 24V DC | Direct | | Red, Amber, Green | | 3.9W | 0.275kg |
| LR4-302WJNW-RYGZ | | Φ40 | 3 | 24V DC | Direct | | Red, Amber, Green | • | 3.9W | 0.275kg |
| LR4-402WJNW(U)-RYGB | | Φ40 | 4 | 24V DC | Direct | | Red, Amber, Green, Blue | | 5.2W | 0.31kg |
| LR4-502WJNW(U)-RYGBC | | Φ40 | 5 | 24V DC | Direct | | Red, Amber, Green, Blue, White | | 6.5W | 0.345kg |
| LR4-102WJBW(U)-R/Y/G | | Φ40 | 1 | 24V DC | Direct | ✓ | Red / Amber / Green | | 2.6W | 0.24kg |
| LR4-202WJBW(U)-RY/RG | | Φ40 | 2 | 24V DC | Direct | ✓ | Red, Amber / Red, Green | | 3.9W | 0.275kg |
| LR4-302WJBW(U)-RYG | | Φ40 | 3 | 24V DC | Direct | ✓ | Red, Amber, Green | | 5.2W | 0.31kg |
| LR4-302WJBW-RYGZ | | Φ40 | 3 | 24V DC | Direct | ✓ | Red, Amber, Green | • | 5.2W | 0.31kg |
| LR4-402WJBW(U)-RYGB | | Φ40 | 4 | 24V DC | Direct | ✓ | Red, Amber, Green, Blue | | 6.5W | 0.345kg |
| LR4-502WJBW(U)-RYGBC | | Φ40 | 5 | 24V DC | Direct | ✓ | Red, Amber, Green, Blue, White | | 7.8W | 0.38kg |
| LR4-1M2WJNW-R/Y/G | | Φ40 | 1 | 100 - 240V AC | Direct | | Red / Amber / Green | | 1.8W | 0.29kg |
| LR4-2M2WJNW-RY/RG | | Φ40 | 2 | 100 - 240V AC | Direct | | Red, Amber / Red, Green | | 3.6W | 0.32kg |
| LR4-3M2WJNW-RYG | | Φ40 | 3 | 100 - 240V AC | Direct | | Red, Amber, Green | | 5.4W | 0.355kg |
| LR4-4M2WJNW-RYGB | | Φ40 | 4 | 100 - 240V AC | Direct | | Red, Amber, Green, Blue | | 7.2W | 0.39kg |
| LR4-5M2WJNW-RYGBC | | Φ40 | 5 | 100 - 240V AC | Direct | | Red, Amber, Green, Blue, White | | 9W | 0.43kg |
| LR4-1M2WJBW-R/Y/G | | Φ40 | 1 | 100 - 240V AC | Direct | ✓ | Red / Amber / Green | | 3.6W | 0.32kg |
| LR4-2M2WJBW-RY/RG | | Φ40 | 2 | 100 - 240V AC | Direct | ✓ | Red, Amber / Red, Green | | 5.4W | 0.36kg |
| LR4-3M2WJBW-RYG | | Φ40 | 3 | 100 - 240V AC | Direct | ✓ | Red, Amber, Green | | 7.2W | 0.39kg |
| LR4-4M2WJBW-RYGB | | Φ40 | 4 | 100 - 240V AC | Direct | ✓ | Red, Amber, Green, Blue | | 9W | 0.43kg |
| LR4-5M2WJBW-RYGBC | | Φ40 | 5 | 100 - 240V AC | Direct | ✓ | Red, Amber, Green, Blue, White | | 10.8W | 0.46kg |
| LR5-101WJNW-R/Y/G | | Φ50 | 1 | 12V DC | Direct | | Red / Amber / Green | | 1.1W | 0.24kg |
| LR5-201WJNW-RY/RG | | Φ50 | 2 | 12V DC | Direct | | Red, Amber / Red, Green | | 2.2W | 0.28kg |
| LR5-301WJNW-RYG | | Φ50 | 3 | 12V DC | Direct | | Red, Amber, Green | | 3.3W | 0.32kg |
| LR5-401WJNW-RYGB | | Φ50 | 4 | 12V DC | Direct | | Red, Amber, Green, Blue | | 4.4W | 0.36kg |
| LR5-501WJNW-RYGBC | | Φ50 | 5 | 12V DC | Direct | | Red, Amber, Green, Blue, White | | 5.5W | 0.4kg |
| LR5-101WJBW-R/Y/G | | Φ50 | 1 | 12V DC | Direct | ✓ | Red / Amber / Green | | 2.3W | 0.29kg |
| LR5-201WJBW-RY/RG | | Φ50 | 2 | 12V DC | Direct | ✓ | Red, Amber / Red, Green | | 3.4W | 0.33kg |
| LR5-301WJBW-RYG | | Φ50 | 3 | 12V DC | Direct | ✓ | Red, Amber, Green | | 4.5W | 0.37kg |
| LR5-401WJBW-RYGB | | Φ50 | 4 | 12V DC | Direct | ✓ | Red, Amber, Green, Blue | | 5.6W | 0.41kg |
| LR5-501WJBW-RYGBC | | Φ50 | 5 | 12V DC | Direct | ✓ | Red, Amber, Green, Blue, White | | 6.7W | 0.45kg |
| LR5-102WJNW-R/Y/G | | Φ50 | 1 | 24V DC | Direct | | Red / Amber / Green | | 1.3W | 0.24kg |
| LR5-202WJNW-RY/RG | | Φ50 | 2 | 24V DC | Direct | | Red, Amber / Red, Green | | 2.6W | 0.28kg |
| LR5-302WJNW-RYG | | Φ50 | 3 | 24V DC | Direct | | Red, Amber, Green | | 3.9W | 0.32kg |

Product List Pre-Assembled Models

 Compatible with WD Wireless Data Acquisition products (page. 11 - 13)

| Model Number | WD Compatible | Size (mm) | Number of Tiers | Rated Voltage | Mounting | Alarm | Luminous Color | Clear Globe | Power Consumption | Mass |
|----------------------|---|-----------|-----------------|---------------|---------------------|-------|--------------------------------|-------------|-------------------|---------|
| LR5-402WJNW-RYGB |  | Φ50 | 4 | 24V DC | Direct | | Red, Amber, Green, Blue | | 5.2W | 0.36kg |
| LR5-502WJNW-RYGB |  | Φ50 | 5 | 24V DC | Direct | | Red, Amber, Green, Blue, White | | 6.5W | 0.4kg |
| LR5-102WJBW-R/Y/G |  | Φ50 | 1 | 24V DC | Direct | ✓ | Red / Amber / Green | | 2.6W | 0.29kg |
| LR5-202WJBW-RY/RG |  | Φ50 | 2 | 24V DC | Direct | ✓ | Red, Amber / Red, Green | | 3.9W | 0.33kg |
| LR5-302WJBW-RYG |  | Φ50 | 3 | 24V DC | Direct | ✓ | Red, Amber, Green | | 5.2W | 0.37kg |
| LR5-402WJBW-RYGB |  | Φ50 | 4 | 24V DC | Direct | ✓ | Red, Amber, Green, Blue | | 6.5W | 0.41kg |
| LR5-502WJBW-RYGB |  | Φ50 | 5 | 24V DC | Direct | ✓ | Red, Amber, Green, Blue, White | | 7.8W | 0.45kg |
| LR6-102WJNW(U)-R/Y/G |  | Φ60 | 1 | 24V DC | Direct | | Red / Amber / Green | | 1.3W | 0.28kg |
| LR6-202WJNW(U)-RY/RG |  | Φ60 | 2 | 24V DC | Direct | | Red, Amber / Red, Green | | 2.6W | 0.34kg |
| LR6-302WJNW(U)-RYG |  | Φ60 | 3 | 24V DC | Direct | | Red, Amber, Green | | 3.9W | 0.4kg |
| LR6-302WJNW(U)-RYGZ |  | Φ60 | 3 | 24V DC | Direct | | Red, Amber, Green | • | 3.9W | 0.4kg |
| LR6-402WJNW(U)-RYGB |  | Φ60 | 4 | 24V DC | Direct | | Red, Amber, Green, Blue | | 5.2W | 0.46kg |
| LR6-502WJNW(U)-RYGB |  | Φ60 | 5 | 24V DC | Direct | | Red, Amber, Green, Blue, White | | 6.5W | 0.52kg |
| LR6-102WJBW(U)-R/Y/G |  | Φ60 | 1 | 24V DC | Direct | ✓ | Red / Amber / Green | | 2.6W | 0.34kg |
| LR6-202WJBW(U)-RY/RG |  | Φ60 | 2 | 24V DC | Direct | ✓ | Red, Amber / Red, Green | | 3.9W | 0.4kg |
| LR6-302WJBW(U)-RYG |  | Φ60 | 3 | 24V DC | Direct | ✓ | Red, Amber, Green | | 5.2W | 0.46kg |
| LR6-402WJBW(U)-RYGB |  | Φ60 | 4 | 24V DC | Direct | ✓ | Red, Amber, Green, Blue | | 6.5W | 0.52kg |
| LR6-502WJBW(U)-RYGB |  | Φ60 | 5 | 24V DC | Direct | ✓ | Red, Amber, Green, Blue, White | | 7.8W | 0.58kg |
| LR6-1M2WJNW-R/Y/G |  | Φ60 | 1 | 100 - 240V AC | Direct | | Red / Amber / Green | | 1.8W | 0.38kg |
| LR6-2M2WJNW-RY/RG |  | Φ60 | 2 | 100 - 240V AC | Direct | | Red, Amber / Red, Green | | 3.6W | 0.44kg |
| LR6-3M2WJNW-RYG |  | Φ60 | 3 | 100 - 240V AC | Direct | | Red, Amber, Green | | 5.4W | 0.5kg |
| LR6-4M2WJNW-RYGB |  | Φ60 | 4 | 100 - 240V AC | Direct | | Red, Amber, Green, Blue | | 7.2W | 0.56kg |
| LR6-5M2WJNW-RYGB |  | Φ60 | 5 | 100 - 240V AC | Direct | | Red, Amber, Green, Blue, White | | 9W | 0.62kg |
| LR6-1M2WJBW-R/Y/G |  | Φ60 | 1 | 100 - 240V AC | Direct | ✓ | Red / Amber / Green | | 3.6W | 0.44kg |
| LR6-2M2WJBW-RY/RG |  | Φ60 | 2 | 100 - 240V AC | Direct | ✓ | Red, Amber / Red, Green | | 5.4W | 0.5kg |
| LR6-3M2WJBW-RYG |  | Φ60 | 3 | 100 - 240V AC | Direct | ✓ | Red, Amber, Green | | 7.2W | 0.56kg |
| LR6-4M2WJBW-RYGB |  | Φ60 | 4 | 100 - 240V AC | Direct | ✓ | Red, Amber, Green, Blue | | 9W | 0.62kg |
| LR6-5M2WJBW-RYGB |  | Φ60 | 5 | 100 - 240V AC | Direct | ✓ | Red, Amber, Green, Blue, White | | 10.8W | 0.68kg |
| LR7-102WJNW-R/Y/G | | Φ70 | 1 | 24V DC | Direct | | Red / Amber / Green | | 1.3W | 0.31kg |
| LR7-202WJNW-RY/RG | | Φ70 | 2 | 24V DC | Direct | | Red, Amber / Red, Green | | 2.6W | 0.37kg |
| LR7-302WJNW-RYG | | Φ70 | 3 | 24V DC | Direct | | Red, Amber, Green | | 3.9W | 0.435kg |
| LR7-402WJNW-RYGB | | Φ70 | 4 | 24V DC | Direct | | Red, Amber, Green, Blue | | 5.2W | 0.5kg |
| LR7-502WJNW-RYGB | | Φ70 | 5 | 24V DC | Direct | | Red, Amber, Green, Blue, White | | 6.5W | 0.57kg |
| LR7-102WJBW-R/Y/G | | Φ70 | 1 | 24V DC | Direct | ✓ | Red / Amber / Green | | 2.6W | 0.38kg |
| LR7-202WJBW-RY/RG | | Φ70 | 2 | 24V DC | Direct | ✓ | Red, Amber / Red, Green | | 3.9W | 0.44kg |
| LR7-302WJBW-RYG | | Φ70 | 3 | 24V DC | Direct | ✓ | Red, Amber, Green | | 5.2W | 0.505kg |
| LR7-402WJBW-RYGB | | Φ70 | 4 | 24V DC | Direct | ✓ | Red, Amber, Green, Blue | | 6.5W | 0.57kg |
| LR7-502WJBW-RYGB | | Φ70 | 5 | 24V DC | Direct | ✓ | Red, Amber, Green, Blue, White | | 7.8W | 0.635kg |
| LR6-302WJBW-RYGZ |  | Φ60 | 3 | 24V DC | Direct | ✓ | Red, Amber, Green | • | 5.2W | 0.46kg |
| LR4-102LJNW(U)-R/Y/G | | Φ40 | 1 | 24V DC | Pole with L-bracket | | Red / Amber / Green | | 1.3W | 0.495kg |
| LR4-202LJNW(U)-RY/RG | | Φ40 | 2 | 24V DC | Pole with L-bracket | | Red, Amber / Red, Green | | 2.6W | 0.53kg |
| LR4-302LJNW(U)-RYG | | Φ40 | 3 | 24V DC | Pole with L-bracket | | Red, Amber, Green | | 3.9W | 0.565kg |
| LR4-302LJNW(U)-RYGZ | | Φ40 | 3 | 24V DC | Pole with L-bracket | | Red, Amber, Green | • | 3.9W | 0.565kg |
| LR4-402LJNW(U)-RYGB | | Φ40 | 4 | 24V DC | Pole with L-bracket | | Red, Amber, Green, Blue | | 5.2W | 0.6kg |
| LR4-502LJNW(U)-RYGB | | Φ40 | 5 | 24V DC | Pole with L-bracket | | Red, Amber, Green, Blue, White | | 6.5W | 0.635kg |
| LR4-102LJBW(U)-R/Y/G | | Φ40 | 1 | 24V DC | Pole with L-bracket | ✓ | Red / Amber / Green | | 2.6W | 0.53kg |
| LR4-202LJBW(U)-RY/RG | | Φ40 | 2 | 24V DC | Pole with L-bracket | ✓ | Red, Amber / Red, Green | | 3.9W | 0.565kg |
| LR4-302LJBW(U)-RYG | | Φ40 | 3 | 24V DC | Pole with L-bracket | ✓ | Red, Amber, Green | | 5.2W | 0.6kg |
| LR4-302LJBW(U)-RYGZ | | Φ40 | 3 | 24V DC | Pole with L-bracket | ✓ | Red, Amber, Green | • | 5.2W | 0.6kg |
| LR4-402LJBW(U)-RYGB | | Φ40 | 4 | 24V DC | Pole with L-bracket | ✓ | Red, Amber, Green, Blue | | 6.5W | 0.635kg |
| LR4-502LJBW(U)-RYGB | | Φ40 | 5 | 24V DC | Pole with L-bracket | ✓ | Red, Amber, Green, Blue, White | | 7.8W | 0.67kg |
| * LR4-1M2LJNW-R/Y/G | | Φ40 | 1 | 100 - 240V AC | Pole with L-bracket | | Red / Amber / Green | | 1.8W | 0.575kg |
| * LR4-2M2LJNW-RY/RG | | Φ40 | 2 | 100 - 240V AC | Pole with L-bracket | | Red, Amber / Red, Green | | 3.6W | 0.61kg |
| * LR4-3M2LJNW-RYG | | Φ40 | 3 | 100 - 240V AC | Pole with L-bracket | | Red, Amber, Green | | 5.4W | 0.645kg |
| * LR4-4M2LJNW-RYGB | | Φ40 | 4 | 100 - 240V AC | Pole with L-bracket | | Red, Amber, Green, Blue | | 7.2W | 0.68kg |
| * LR4-5M2LJNW-RYGB | | Φ40 | 5 | 100 - 240V AC | Pole with L-bracket | | Red, Amber, Green, Blue, White | | 9W | 0.715kg |

Product List Pre-Assembled Models

Compatible with WD Wireless Data Acquisition products (page. 11 - 13)

| Model Number | WD Compatible | Size (mm) | Number of Tiers | Rated Voltage | Mounting | Alarm | Luminous Color | Clear Globe | Power Consumption | Mass |
|----------------------|---------------|-----------|-----------------|---------------|----------------------------|-------|------------------------------------|-------------|-------------------|---------|
| * LR4-1M2LJBW-R/Y/G | | Φ40 | 1 | 100 - 240V AC | Pole with L-bracket | ✓ | Red / Amber / Green | | 3.6W | 0.61kg |
| * LR4-2M2LJBW-RY/RG | | Φ40 | 2 | 100 - 240V AC | Pole with L-bracket | ✓ | Red, Amber / Red, Green | | 5.4W | 0.645kg |
| * LR4-3M2LJBW-RYG | | Φ40 | 3 | 100 - 240V AC | Pole with L-bracket | ✓ | Red, Amber, Green | | 7.2W | 0.68kg |
| * LR4-4M2LJBW-RYGB | | Φ40 | 4 | 100 - 240V AC | Pole with L-bracket | ✓ | Red, Amber, Green, Blue | | 9W | 0.715kg |
| * LR4-5M2LJBW-RYGBC | | Φ40 | 5 | 100 - 240V AC | Pole with L-bracket | ✓ | Red, Amber, Green, Blue, White | | 10.8W | 0.75kg |
| LR5-101LJNW-R/Y/G | ☐ | Φ50 | 1 | 12V DC | Pole with L-bracket | | Red / Amber / Green | | 1.1W | 0.53kg |
| LR5-201LJNW-RY/RG | ☐ | Φ50 | 2 | 12V DC | Pole with L-bracket | | Red, Amber / Red, Green | | 2.2W | 0.57kg |
| LR5-301LJNW-RYG | ☐ | Φ50 | 3 | 12V DC | Pole with L-bracket | | Red, Amber, Green | | 3.3W | 0.61kg |
| LR5-401LJNW-RYGB | ☐ | Φ50 | 4 | 12V DC | Pole with L-bracket | | Red, Amber, Green, Blue | | 4.4W | 0.65kg |
| LR5-501LJNW-RYGBC | ☐ | Φ50 | 5 | 12V DC | Pole with L-bracket | | Red, Amber, Green, Blue, White | | 5.5W | 0.69kg |
| LR5-101LJBW-R/Y/G | ☐ | Φ50 | 1 | 12V DC | Pole with L-bracket | ✓ | Red / Amber / Green | | 2.3W | 0.58kg |
| LR5-201LJBW-RY/RG | ☐ | Φ50 | 2 | 12V DC | Pole with L-bracket | ✓ | Red, Amber / Red, Green | | 3.4W | 0.57kg |
| LR5-301LJBW-RYG | ☐ | Φ50 | 3 | 12V DC | Pole with L-bracket | ✓ | Red, Amber, Green | | 4.5W | 0.66kg |
| LR5-401LJBW-RYGB | ☐ | Φ50 | 4 | 12V DC | Pole with L-bracket | ✓ | Red, Amber, Green, Blue | | 5.6W | 0.65kg |
| LR5-501LJBW-RYGBC | ☐ | Φ50 | 5 | 12V DC | Pole with L-bracket | ✓ | Red, Amber, Green, Blue, White | | 6.7W | 0.74kg |
| LR5-102LJNW-R/Y/G | ☐ | Φ50 | 1 | 24V DC | Pole with L-bracket | | Red / Amber / Green | | 1.3W | 0.53kg |
| LR5-202LJNW-RY/RG | ☐ | Φ50 | 2 | 24V DC | Pole with L-bracket | | Red, Amber / Red, Green | | 2.6W | 0.57kg |
| LR5-302LJNW-RYG | ☐ | Φ50 | 3 | 24V DC | Pole with L-bracket | | Red, Amber, Green | | 3.9W | 0.61kg |
| LR5-402LJNW-RYGB | ☐ | Φ50 | 4 | 24V DC | Pole with L-bracket | | Red, Amber, Green, Blue | | 5.2W | 0.65kg |
| LR5-502LJNW-RYGBC | ☐ | Φ50 | 5 | 24V DC | Pole with L-bracket | | Red · Amber · Green · Blue · White | | 6.5W | 0.69kg |
| LR5-102LJBW-R/Y/G | ☐ | Φ50 | 1 | 24V DC | Pole with L-bracket | ✓ | Red / Amber / Green | | 2.6W | 0.58kg |
| LR5-202LJBW-RY/RG | ☐ | Φ50 | 2 | 24V DC | Pole with L-bracket | ✓ | Red, Amber / Red, Green | | 3.9W | 0.62kg |
| LR5-302LJBW-RYG | ☐ | Φ50 | 3 | 24V DC | Pole with L-bracket | ✓ | Red, Amber, Green | | 5.2W | 0.66kg |
| LR5-402LJBW-RYGB | ☐ | Φ50 | 4 | 24V DC | Pole with L-bracket | ✓ | Red, Amber, Green, Blue | | 6.5W | 0.7kg |
| LR5-502LJBW-RYGBC | ☐ | Φ50 | 5 | 24V DC | Pole with L-bracket | ✓ | Red, Amber, Green, Blue, White | | 7.8W | 0.74kg |
| LR6-102LJNW(U)-R/Y/G | ☐ | Φ60 | 1 | 24V DC | Pole with L-bracket | | Red / Amber / Green | | 1.3W | 0.56kg |
| LR6-202LJNW(U)-RY/RG | ☐ | Φ60 | 2 | 24V DC | Pole with L-bracket | | Red, Amber / Red, Green | | 2.6W | 0.62kg |
| LR6-302LJNW(U)-RYG | ☐ | Φ60 | 3 | 24V DC | Pole with L-bracket | | Red, Amber, Green | | 3.9W | 0.68kg |
| LR6-302LJNW-RYGZ | ☐ | Φ60 | 3 | 24V DC | Pole with L-bracket | | Red, Amber, Green | • | 3.9W | 0.68kg |
| LR6-402LJNW(U)-RYGB | ☐ | Φ60 | 4 | 24V DC | Pole with L-bracket | | Red, Amber, Green, Blue | | 5.2W | 0.74kg |
| LR6-502LJNW(U)-RYGBC | ☐ | Φ60 | 5 | 24V DC | Pole with L-bracket | | Red, Amber, Green, Blue, White | | 6.5W | 0.8kg |
| LR6-102LJBW(U)-R/Y/G | ☐ | Φ60 | 1 | 24V DC | Pole with L-bracket | ✓ | Red / Amber / Green | | 2.6W | 0.62kg |
| LR6-202LJBW(U)-RY/RG | ☐ | Φ60 | 2 | 24V DC | Pole with L-bracket | ✓ | Red, Amber / Red, Green | | 3.9W | 0.68kg |
| LR6-302LJBW(U)-RYG | ☐ | Φ60 | 3 | 24V DC | Pole with L-bracket | ✓ | Red, Amber, Green | | 5.2W | 0.74kg |
| LR6-402LJBW(U)-RYGZ | ☐ | Φ60 | 3 | 24V DC | Pole with L-bracket | ✓ | Red, Amber, Green | • | 5.2W | 0.74kg |
| LR6-402LJBW(U)-RYGB | ☐ | Φ60 | 4 | 24V DC | Pole with L-bracket | ✓ | Red, Amber, Green, Blue | | 6.5W | 0.8kg |
| LR6-502LJBW(U)-RYGBC | ☐ | Φ60 | 5 | 24V DC | Pole with L-bracket | ✓ | Red, Amber, Green, Blue, White | | 7.8W | 0.86kg |
| * LR6-1M2LJNW-R/Y/G | ☐ | Φ60 | 1 | 100 - 240V AC | Pole with L-bracket | | Red / Amber / Green | | 1.8W | 0.66kg |
| * LR6-2M2LJNW-RY/RG | ☐ | Φ60 | 2 | 100 - 240V AC | Pole with L-bracket | | Red, Amber / Red, Green | | 3.6W | 0.72kg |
| * LR6-3M2LJNW-RYG | ☐ | Φ60 | 3 | 100 - 240V AC | Pole with L-bracket | | Red, Amber, Green | | 5.4W | 0.78kg |
| * LR6-4M2LJNW-RYGB | ☐ | Φ60 | 4 | 100 - 240V AC | Pole with L-bracket | | Red, Amber, Green, Blue | | 7.2W | 0.84kg |
| * LR6-5M2LJNW-RYGBC | ☐ | Φ60 | 5 | 100 - 240V AC | Pole with L-bracket | | Red, Amber, Green, Blue, White | | 9W | 0.9kg |
| * LR6-1M2LJBW-R/Y/G | ☐ | Φ60 | 1 | 100 - 240V AC | Pole with L-bracket | ✓ | Red / Amber / Green | | 3.6W | 0.72kg |
| * LR6-2M2LJBW-RY/RG | ☐ | Φ60 | 2 | 100 - 240V AC | Pole with L-bracket | ✓ | Red, Amber / Red, Green | | 5.4W | 0.78kg |
| * LR6-3M2LJBW-RYG | ☐ | Φ60 | 3 | 100 - 240V AC | Pole with L-bracket | ✓ | Red, Amber, Green | | 7.2W | 0.84kg |
| * LR6-4M2LJBW-RYGB | ☐ | Φ60 | 4 | 100 - 240V AC | Pole with L-bracket | ✓ | Red, Amber, Green, Blue | | 9W | 0.9kg |
| * LR6-5M2LJBW-RYGBC | ☐ | Φ60 | 5 | 100 - 240V AC | Pole with L-bracket | ✓ | Red, Amber, Green, Blue, White | | 10.8W | 0.96kg |
| LR4-102PJNW(U)-R/Y/G | | Φ40 | 1 | 24V DC | Pole with circular bracket | | Red / Amber / Green | | 1.3W | 0.395kg |
| LR4-202PJNW(U)-RY/RG | | Φ40 | 2 | 24V DC | Pole with circular bracket | | Red, Amber / Red, Green | | 2.6W | 0.43kg |
| LR4-302PJNW(U)-RYG | | Φ40 | 3 | 24V DC | Pole with circular bracket | | Red, Amber, Green | | 3.9W | 0.465kg |
| LR4-402PJNW(U)-RYGB | | Φ40 | 4 | 24V DC | Pole with circular bracket | | Red, Amber, Green, Blue | | 5.2W | 0.5kg |
| LR4-502PJNW(U)-RYGBC | | Φ40 | 5 | 24V DC | Pole with circular bracket | | Red, Amber, Green, Blue, White | | 6.5W | 0.535kg |
| LR4-102PJBW(U)-R/Y/G | | Φ40 | 1 | 24V DC | Pole with circular bracket | ✓ | Red / Amber / Green | | 2.6W | 0.43kg |

* Not suitable for KC (KN 61000-6-4, KN 61000-6-2) and Low Voltage Directive (TEC / EN 60947-5-1, EN 62471).

Product List Pre-Assembled Models























 ...Compatible with WD Wireless Data Acquisition products (page. 11 - 13)

| Model Number | WD Compatible | Size (mm) | Number of Tiers | Rated Voltage | Mounting | Alarm | Luminous Color | Clear Globe | Power Consumption | Mass |
|----------------------|---|-----------|-----------------|---------------|----------------------------|-------|------------------------------------|-------------|-------------------|---------|
| LR4-202PJBW(U)-RY/RG | | Φ40 | 2 | 24V DC | Pole with circular bracket | ✓ | Red, Amber / Red, Green | | 3.9W | 0.465kg |
| LR4-302PJBW(U)-RYG | | Φ40 | 3 | 24V DC | Pole with circular bracket | ✓ | Red, Amber, Green | | 5.2W | 0.5kg |
| LR4-402PJBW(U)-RYGB | | Φ40 | 4 | 24V DC | Pole with circular bracket | ✓ | Red, Amber, Green, Blue | | 6.5W | 0.535kg |
| LR4-502PJBW(U)-RYGBC | | Φ40 | 5 | 24V DC | Pole with circular bracket | ✓ | Red, Amber, Green, Blue, White | | 7.8W | 0.57kg |
| LR4-1M2PJNW-R/Y/G | | Φ40 | 1 | 100 - 240V AC | Pole with circular bracket | | Red / Amber / Green | | 1.8W | 0.48kg |
| LR4-2M2PJNW-RY/RG | | Φ40 | 2 | 100 - 240V AC | Pole with circular bracket | | Red, Amber / Red, Green | | 3.6W | 0.51kg |
| LR4-3M2PJNW-RYG | | Φ40 | 3 | 100 - 240V AC | Pole with circular bracket | | Red, Amber, Green | | 5.4W | 0.545kg |
| LR4-4M2PJNW-RYGB | | Φ40 | 4 | 100 - 240V AC | Pole with circular bracket | | Red, Amber, Green, Blue | | 7.2W | 0.58kg |
| LR4-5M2PJNW-RYGBC | | Φ40 | 5 | 100 - 240V AC | Pole with circular bracket | | Red, Amber, Green, Blue, White | | 9W | 0.62kg |
| LR4-1M2PJBW-R/Y/G | | Φ40 | 1 | 100 - 240V AC | Pole with circular bracket | ✓ | Red / Amber / Green | | 3.6W | 0.51kg |
| LR4-2M2PJBW-RY/RG | | Φ40 | 2 | 100 - 240V AC | Pole with circular bracket | ✓ | Red, Amber / Red, Green | | 5.4W | 0.55kg |
| LR4-3M2PJBW-RYG | | Φ40 | 3 | 100 - 240V AC | Pole with circular bracket | ✓ | Red, Amber, Green | | 7.2W | 0.58kg |
| LR4-4M2PJBW-RYGB | | Φ40 | 4 | 100 - 240V AC | Pole with circular bracket | ✓ | Red, Amber, Green, Blue | | 9W | 0.62kg |
| LR4-5M2PJBW-RYGBC | | Φ40 | 5 | 100 - 240V AC | Pole with circular bracket | ✓ | Red, Amber, Green, Blue, White | | 10.8W | 0.65kg |
| LR5-101PJNW-R/Y/G |  | Φ50 | 1 | 12V DC | Pole with circular bracket | | Red / Amber / Green | | 1.1W | 0.42kg |
| LR5-201PJNW-RY/RG |  | Φ50 | 2 | 12V DC | Pole with circular bracket | | Red, Amber / Red, Green | | 2.2W | 0.46kg |
| LR5-301PJNW-RYG |  | Φ50 | 3 | 12V DC | Pole with circular bracket | | Red, Amber, Green | | 3.3W | 0.5kg |
| LR5-401PJNW-RYGB |  | Φ50 | 4 | 12V DC | Pole with circular bracket | | Red, Amber, Green, Blue | | 4.4W | 0.54kg |
| LR5-501PJNW-RYGBC |  | Φ50 | 5 | 12V DC | Pole with circular bracket | | Red, Amber, Green, Blue, White | | 5.5W | 0.58kg |
| LR5-101PJBW-R/Y/G |  | Φ50 | 1 | 12V DC | Pole with circular bracket | ✓ | Red / Amber / Green | | 2.3W | 0.47kg |
| LR5-201PJBW-RY/RG |  | Φ50 | 2 | 12V DC | Pole with circular bracket | ✓ | Red, Amber / Red, Green | | 3.4W | 0.51kg |
| LR5-301PJBW-RYG |  | Φ50 | 3 | 12V DC | Pole with circular bracket | ✓ | Red, Amber, Green | | 4.5W | 0.55kg |
| LR5-401PJBW-RYGB |  | Φ50 | 4 | 12V DC | Pole with circular bracket | ✓ | Red, Amber, Green, Blue | | 5.6W | 0.59kg |
| LR5-501PJBW-RYGBC |  | Φ50 | 5 | 12V DC | Pole with circular bracket | ✓ | Red, Amber, Green, Blue, White | | 6.7W | 0.63kg |
| LR5-102PJNW-R/Y/G |  | Φ50 | 1 | 24V DC | Pole with circular bracket | | Red/Amber/Green | | 1.3W | 0.42kg |
| LR5-202PJNW-RY/RG |  | Φ50 | 2 | 24V DC | Pole with circular bracket | | Red, Amber, red, and green | | 2.6W | 0.46kg |
| LR5-302PJNW-RYG |  | Φ50 | 3 | 24V DC | Pole with circular bracket | | Red · Amber · Green | | 3.9W | 0.5kg |
| LR5-402PJNW-RYGB |  | Φ50 | 4 | 24V DC | Pole with circular bracket | | Red · Amber · Green · Blue | | 5.2W | 0.54kg |
| LR5-502PJNW-RYGBC |  | Φ50 | 5 | 24V DC | Pole with circular bracket | | Red · Amber · Green · Blue · White | | 6.5W | 0.58kg |
| LR5-102PJBW-R/Y/G |  | Φ50 | 1 | 24V DC | Pole with circular bracket | ✓ | Red/Amber/Green | | 2.6W | 0.47kg |
| LR5-202PJBW-RY/RG |  | Φ50 | 2 | 24V DC | Pole with circular bracket | ✓ | Red, Amber, red, and green | | 3.9W | 0.51kg |
| LR5-302PJBW-RYG |  | Φ50 | 3 | 24V DC | Pole with circular bracket | ✓ | Red · Amber · Green | | 5.2W | 0.55kg |
| LR5-402PJBW-RYGB |  | Φ50 | 4 | 24V DC | Pole with circular bracket | ✓ | Red · Amber · Green · Blue | | 6.5W | 0.59kg |
| LR5-502PJBW-RYGBC |  | Φ50 | 5 | 24V DC | Pole with circular bracket | ✓ | Red · Amber · Green · Blue · White | | 7.8W | 0.63kg |
| LR6-102PJNW-R/Y/G |  | Φ60 | 1 | 24V DC | Pole with circular bracket | | Red / Amber / Green | | 1.3W | 0.46kg |
| LR6-202PJNW-RY/RG |  | Φ60 | 2 | 24V DC | Pole with circular bracket | | Red, Amber / Red, Green | | 2.6W | 0.52kg |
| LR6-302PJNW-RYG |  | Φ60 | 3 | 24V DC | Pole with circular bracket | | Red, Amber, Green | | 3.9W | 0.58kg |
| LR6-402PJNW-RYGB |  | Φ60 | 4 | 24V DC | Pole with circular bracket | | Red, Amber, Green, Blue | | 5.2W | 0.64kg |
| LR6-502PJNW-RYGBC |  | Φ60 | 5 | 24V DC | Pole with circular bracket | | Red, Amber, Green, Blue, White | | 6.5W | 0.7kg |
| LR6-102PJBW-R/Y/G |  | Φ60 | 1 | 24V DC | Pole with circular bracket | ✓ | Red / Amber / Green | | 2.6W | 0.52kg |
| LR6-202PJBW-RY/RG |  | Φ60 | 2 | 24V DC | Pole with circular bracket | ✓ | Red, Amber / Red, Green | | 3.9W | 0.58kg |
| LR6-302PJBW-RYG |  | Φ60 | 3 | 24V DC | Pole with circular bracket | ✓ | Red, Amber, Green | | 5.2W | 0.64kg |
| LR6-402PJBW-RYGB |  | Φ60 | 4 | 24V DC | Pole with circular bracket | ✓ | Red, Amber, Green, Blue | | 6.5W | 0.7kg |
| LR6-502PJBW-RYGBC |  | Φ60 | 5 | 24V DC | Pole with circular bracket | ✓ | Red, Amber, Green, Blue, White | | 7.8W | 0.76kg |

* Not suitable for KC (KN 61000-6-4, KN 61000-6-2) and Low Voltage Directive (TEC / EN 60947-5-1, EN 62471).

Product List Pre-Assembled Models

 ...Compatible with WD Wireless Data Acquisition products (page. 11 - 13)

| Model Number | WD Compatible | Size (mm) | Number of Tiers | Rated Voltage | Mounting | Alarm | Luminous Color | Clear Globe | Power Consumption | Mass |
|-------------------|---|-----------|-----------------|---------------|-----------------------------|-------|--------------------------------|-------------|-------------------|---------|
| LR6-1M2PJNW-R/Y/G |  | Φ60 | 1 | 100 - 240V AC | Pole with circular bracket | | Red / Amber / Green | | 1.8W | 0.56kg |
| LR6-2M2PJNW-RY/RG |  | Φ60 | 2 | 100 - 240V AC | Pole with circular bracket | | Red, Amber / Red, Green | | 3.6W | 0.62kg |
| LR6-3M2PJNW-RYG |  | Φ60 | 3 | 100 - 240V AC | Pole with circular bracket | | Red, Amber, Green | | 5.4W | 0.68kg |
| LR6-4M2PJNW-RYGB |  | Φ60 | 4 | 100 - 240V AC | Pole with circular bracket | | Red, Amber, Green, Blue | | 7.2W | 0.74kg |
| LR6-5M2PJNW-RYGBC |  | Φ60 | 5 | 100 - 240V AC | Pole with circular bracket | | Red, Amber, Green, Blue, White | | 9W | 0.8kg |
| LR6-1M2PJBW-R/Y/G |  | Φ60 | 1 | 100 - 240V AC | Pole with circular bracket | ✓ | Red / Amber / Green | | 3.6W | 0.62kg |
| LR6-2M2PJBW-RY/RG |  | Φ60 | 2 | 100 - 240V AC | Pole with circular bracket | ✓ | Red, Amber / Red, Green | | 5.4W | 0.68kg |
| LR6-3M2PJBW-RYG |  | Φ60 | 3 | 100 - 240V AC | Pole with circular bracket | ✓ | Red, Amber, Green | | 7.2W | 0.74kg |
| LR6-4M2PJBW-RYGB |  | Φ60 | 4 | 100 - 240V AC | Pole with circular bracket | ✓ | Red, Amber, Green, Blue | | 9W | 0.8kg |
| LR6-5M2PJBW-RYGBC |  | Φ60 | 5 | 100 - 240V AC | Pole with circular bracket | ✓ | Red, Amber, Green, Blue, White | | 10.8W | 0.86kg |
| LR6-302PJNW-RYGZ |  | Φ60 | 3 | 24V DC | Pole with circular bracket | | Red, Amber, Green | • | 3.9W | 0.58kg |
| LR6-302PJBW-RYGZ |  | Φ60 | 3 | 24V DC | Pole with circular bracket | ✓ | Red, Amber, Green | • | 5.2W | 0.64kg |
| LR4-102QJNW-R/Y/G | | Φ40 | 1 | 24V DC | Pole with folding bracket | | Red / Amber / Green | | 1.3W | 0.455kg |
| LR4-202QJNW-RY/RG | | Φ40 | 2 | 24V DC | Pole with folding bracket | | Red, Amber / Red, Green | | 2.6W | 0.49kg |
| LR4-302QJNW-RYG | | Φ40 | 3 | 24V DC | Pole with folding bracket | | Red, Amber, Green | | 3.9W | 0.525kg |
| LR4-402QJNW-RYGB | | Φ40 | 4 | 24V DC | Pole with folding bracket | | Red, Amber, Green, Blue | | 5.2W | 0.56kg |
| LR4-502QJNW-RYGBC | | Φ40 | 5 | 24V DC | Pole with folding bracket | | Red, Amber, Green, Blue, White | | 6.5W | 0.595kg |
| LR4-102QJBW-R/Y/G | | Φ40 | 1 | 24V DC | Pole with folding bracket | ✓ | Red / Amber / Green | | 2.6W | 0.49kg |
| LR4-202QJBW-RY/RG | | Φ40 | 2 | 24V DC | Pole with folding bracket | ✓ | Red, Amber / Red, Green | | 3.9W | 0.525kg |
| LR4-302QJBW-RYG | | Φ40 | 3 | 24V DC | Pole with folding bracket | ✓ | Red, Amber, Green | | 5.2W | 0.56kg |
| LR4-402QJBW-RYGB | | Φ40 | 4 | 24V DC | Pole with folding bracket | ✓ | Red, Amber, Green, Blue | | 6.5W | 0.595kg |
| LR4-502QJBW-RYGBC | | Φ40 | 5 | 24V DC | Pole with folding bracket | ✓ | Red, Amber, Green, Blue, White | | 7.8W | 0.63kg |
| LR6-102QJNW-R/Y/G |  | Φ60 | 1 | 24V DC | Pole with folding bracket | | Red / Amber / Green | | 1.3W | 0.52kg |
| LR6-202QJNW-RY/RG |  | Φ60 | 2 | 24V DC | Pole with folding bracket | | Red, Amber / Red, Green | | 2.6W | 0.58kg |
| LR6-302QJNW-RYG |  | Φ60 | 3 | 24V DC | Pole with folding bracket | | Red, Amber, Green | | 3.9W | 0.64kg |
| LR6-402QJNW-RYGB |  | Φ60 | 4 | 24V DC | Pole with folding bracket | | Red, Amber, Green, Blue | | 5.2W | 0.7kg |
| LR6-502QJNW-RYGBC |  | Φ60 | 5 | 24V DC | Pole with folding bracket | | Red, Amber, Green, Blue, White | | 6.5W | 0.76kg |
| LR6-102QJBW-R/Y/G |  | Φ60 | 1 | 24V DC | Pole with folding bracket | ✓ | Red / Amber / Green | | 2.6W | 0.58kg |
| LR6-202QJBW-RY/RG |  | Φ60 | 2 | 24V DC | Pole with folding bracket | ✓ | Red, Amber / Red, Green | | 3.9W | 0.64kg |
| LR6-302QJBW-RYG |  | Φ60 | 3 | 24V DC | Pole with folding bracket | ✓ | Red, Amber, Green | | 5.2W | 0.7kg |
| LR6-402QJBW-RYGB |  | Φ60 | 4 | 24V DC | Pole with folding bracket | ✓ | Red, Amber, Green, Blue | | 6.5W | 0.76kg |
| LR6-502QJBW-RYGBC |  | Φ60 | 5 | 24V DC | Pole with folding bracket | ✓ | Red, Amber, Green, Blue, White | | 7.8W | 0.82kg |
| LR6-302WCNW-RYG |  | Φ60 | 3 | 24V DC | Multi-mount / M12 connector | ✓ | Red, Amber, Green | | 3.0W | 0.35kg |

Select Alarm Unit for Flashing / Alarm Function



LR4~7

Φ40~70

| Model Number | Size (mm) | Mass |
|--------------|-----------|---------|
| LR4-BW/U | Φ40 | 0.035kg |
| LR5-BW/U/K | Φ50 | 0.05kg |
| LR5-BW+B0960 | Φ50 | 0.05kg |
| LR6-BW/U | Φ60 | 0.06kg |
| LR6-BW+B0960 | Φ60 | 0.06kg |
| LR7-BW/U/K | Φ70 | 0.07kg |

Select LED Unit(s)



LR4~7

Φ40~70

| Model Number | Size (mm) | Luminous Color | Clear Globe | Mass |
|-------------------|-----------|------------------------------|-------------|---------|
| LR4-E-R/Y/G/B/C | Φ40 | Red/ Amber /Green/Blue/White | | 0.035kg |
| LR4-E-RZ/YZ/GZ/BZ | Φ40 | Red/ Amber/Green/Blue | • | 0.035kg |
| LR5-E-R/Y/G/B/C | Φ50 | Red/ Amber /Green/Blue/White | | 0.04kg |
| LR6-E-R/Y/G/B/C | Φ60 | Red/ Amber /Green/Blue/White | | 0.04kg |
| LR6-E-RZ/YZ/GZ/BZ | Φ60 | Red/ Amber/Green/Blue | • | 0.06kg |
| LR6-E-MZ | Φ60 | Multi-color 7 colors | • | 0.06kg |
| LR7-E-R/Y/G/B/C | Φ70 | Red/ Amber /Green/Blue/White | | 0.065kg |
| LR4-E-R/Y/G/B/C-A | Φ40 | Red/ Amber /Green/Blue/White | | 0.035kg |

Select Body Unit

| Model Number | Size (mm) | Rated Voltage | Mounting | Wiring | Mass |
|------------------|-----------|---------------|--------------------------------|--------------------------|--------|
| LR4-02WJNW(U) | Φ40 | 24V DC | Direct | Cable | 0.17kg |
| LR4-M2WJNW | Φ40 | 100~240V AC | Direct | Cable | 0.25kg |
| LR5-01WJNW | Φ50 | 12V DC | Direct | Cable | 0.2kg |
| LR5-02WJNW | Φ50 | 24V DC | Direct | Cable | 0.2kg |
| LR6-02WJNW(U) | Φ60 | 24V DC | Direct | Cable | 0.22kg |
| LR6-M2WJNW | Φ60 | 100~240V AC | Direct | Cable | 0.32kg |
| LR7-02WJNW | Φ70 | 24V DC | Direct | Cable | 0.24kg |
| LR5-02WTNW(U)(K) | Φ50 | 24V DC | Direct | Screwless terminal block | 0.10kg |
| LR7-02WTNW(U)(K) | Φ70 | 24V DC | Direct | Screwless terminal block | 0.15kg |
| LR5-02KTNW(U)(K) | Φ50 | 24V DC | Dual-mount with knockout holes | Screwless terminal block | 0.10kg |
| LR7-02KTNW(U)(K) | Φ70 | 24V DC | Dual-mount with knockout holes | Screwless terminal block | 0.15kg |
| LR4-02LJNW(U) | Φ40 | 24V DC | Pole with L-bracket | Cable | 0.46kg |
| LR4-M2LJNW | Φ40 | 100~240V AC | Pole with L-bracket | Cable | 0.54kg |
| LR5-01LJNW | Φ50 | 12V DC | Pole with L-bracket | Cable | 0.49kg |
| LR5-02LJNW | Φ50 | 24V DC | Pole with L-bracket | Cable | 0.49kg |

LR6-02WJNW

① ② ③ ④ ⑤

- | | | | | |
|--|---|--|---|---|
| ① Size 4 = φ40 5 = φ50 6 = φ60 7 = φ70 | ② Rated Voltage 01 = 12V DC* ¹ 02 = 24V DC M2 = 100 - 240V AC* ² | ③ Mounting/Wiring WJ = Direct Mount/Cable WT = Direct Mount/Terminal* ³ KT = Knock-outs Mount/Terminal* ³ WC = Direct Mount/M12 Connector* ⁴ LJ = Pole Mount with L-bracket/Cable* ⁵ PJ = Pole Mount with Circular Bracket/Cable* ⁵ QJ = Pole Mount with Folding Bracket/Cable* ⁵ | ④ Flashing/Buzzer N = No Flashing/Buzzer | ⑤ Body Color W = Off-white U = Silver K = Black ⁷ |
|--|---|--|---|---|

*1. For LR5 models only
*2. For LR4 and LR6 models with WJ, LJ, and PJ mounting
*3. For LR5, LR7 24V DC models only
*4. For LR6 24V DC models only
*5. For LR4, LR5 and LR6 models
*6. For LR4 and LR6 models with 24V DC, Off-white body only
*7. For LR5, LR7 models only

3 Easy Steps



Setup Video

Scan the QR code to see how easy the LR is to configure.



| Model Number | Size (mm) | Rated Voltage | Mounting | Wiring | Mass |
|---------------|-----------|---------------|----------------------------|---------------|--------|
| LR6-02LJNW(U) | φ60 | 24V DC | Pole with L-bracket | Cable | 0.5kg |
| LR6-M2LJNW | φ60 | 100~240V AC | Pole with L-bracket | Cable | 0.6kg |
| LR4-02PJNW(U) | φ40 | 24V DC | Pole with circular bracket | Cable | 0.36kg |
| LR4-M2PJNW | φ40 | 100~240V AC | Pole with circular bracket | Cable | 0.44kg |
| LR5-01PJNW | φ50 | 12V DC | Pole with circular bracket | Cable | 0.38kg |
| LR5-02PJNW | φ50 | 24V DC | Pole with circular bracket | Cable | 0.38kg |
| LR6-02PJNW(U) | φ60 | 24V DC | Pole with circular bracket | Cable | 0.4kg |
| LR6-M2PJNW | φ60 | 100~240V AC | Pole with circular bracket | Cable | 0.5kg |
| LR6-M2PJNA | φ60 | 100~240V AC | Pole with circular bracket | Cable | 0.5kg |
| LR4-02QJNW | φ40 | 24V DC | Pole with folding bracket | Cable | 0.42kg |
| LR6-02QJNW | φ60 | 24V DC | Pole with folding bracket | Cable | 0.46kg |
| LR6-02WCNW | φ60 | 24V DC | Muilt | M12 Connector | 0.17kg |

Removable Screwless Terminal

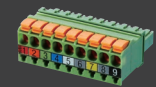

New removable terminal for easy wiring.

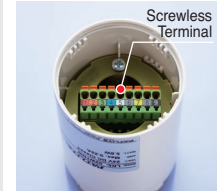

The terminal can be pulled out



Outer Dimensional Drawing (Unit: mm)

Mount A [WJ] Direct Mount/Cable (01: 12V DC / 02: 24V DC) (M2: 100-240V AC)

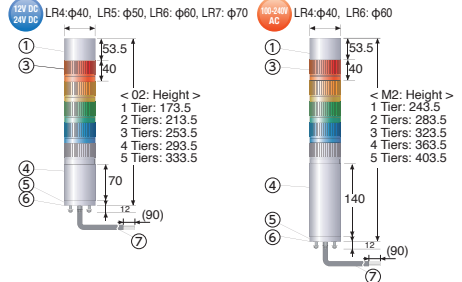

Panel Thickness: 7mm max
Cable Length: (1300)
U type: (3300)
Cable Diameter: $\phi 7.5$

| No. | Description | Material |
|-----|----------------------|-----------------|
| ① | Buzzer Unit | PC |
| ② | Head Cover | PC |
| ③ | LED Unit | Globe: PC |
| ④ | Body | PC |
| ⑤ | Direct Mount Bracket | PC |
| ⑥ | Waterproof Packing | Silicone Rubber |
| ⑦ | Cable | PVC |

Mount A [WT] Direct Mount/Screwless Terminal (Body Unit)

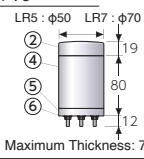

Mount B [LJ] Pole Mount with L-bracket & Cable (01: 12V DC / 02: 24V DC) (M2: 100-240V AC)

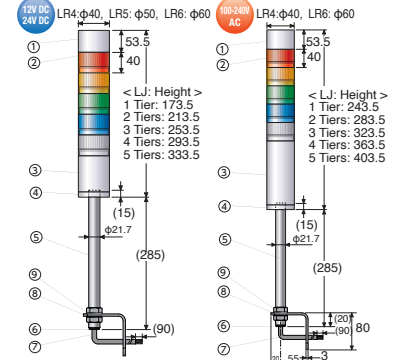

Cable Length: (1000)
U type: (3000)
Cable Diameter: $\phi 7.5$

| No. | Description | Material |
|-----|-----------------|------------|
| ① | Buzzer Unit | PC |
| ② | LED Unit | Globe: PC |
| ③ | Body | PC |
| ④ | Pole Bracket | PC |
| ⑤ | Pole | AL |
| ⑥ | Rubber Bushing | EPR Rubber |
| ⑦ | Cable | PVC |
| ⑧ | L-bracket | Steel |
| ⑨ | Hexagon Nut M22 | SUM |

Mount A [PJ] Pole Mount with/Circular Bracket & Cable (01: 12V DC / 02: 24V DC) (M2: 100-240V AC)

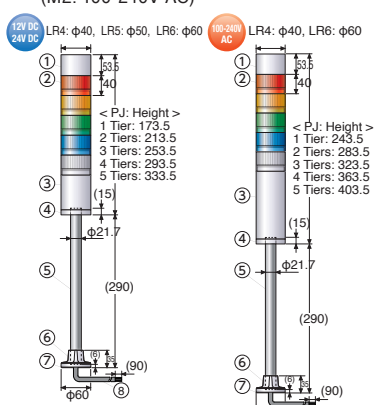

Cable Length: (1000)
U type: (3000)
Cable Diameter: $\phi 7.5$

| No. | Description | Material |
|-----|--------------------|----------------|
| ① | Buzzer Unit | PC |
| ② | LED Unit | Globe: PC |
| ③ | Body | PC |
| ④ | Pole Bracket | PC |
| ⑤ | Pole | AL |
| ⑥ | Circular Bracket | PC |
| ⑦ | Waterproof Packing | Silicon Rubber |
| ⑧ | Cable | PVC |

Mount C [QJ] Pole Mount with Folding Bracket & Cable (02: 24V DC)

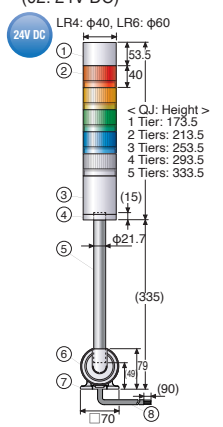

Cable Length: (950)
Cable Diameter: $\phi 7.5$

| No. | Description | Material |
|-----|--------------------|-----------|
| ① | Buzzer Unit | PC |
| ② | LED Unit | Globe: PC |
| ③ | Body | PC |
| ④ | Pole Bracket | PC |
| ⑤ | Pole | AL |
| ⑥ | Folding Bracket | PC |
| ⑦ | Waterproof Packing | CR |
| ⑧ | Cable | PVC |

Mount D [WC] Direct Mount with M12 Connector (02: 24V DC)

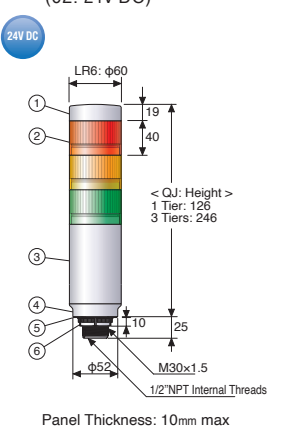

Panel Thickness: 10mm max

| No. | Description | Material |
|-----|----------------------|-----------------|
| ① | Head Cover | PC |
| ② | LED Unit | Globe: PC |
| ③ | Body | PC |
| ④ | Direct Mount Bracket | PC |
| ⑤ | Waterproof Packing | Silicone Rubber |
| ⑥ | M30 Nut | PC |

Mounting Dimensions (Unit: mm)

Mount A Mounting Diagram [WJ] / [PJ] / [WT] / [KT]

| Mounting Holes x3 | Nut/Screw | (*) [KT] Direct Mount when using accessory |
|-------------------|-------------|--|
| LR4/S-WJ | $\phi 4$ M3 | LR4/S-WJ $\phi 30$ |
| LR5-WT/KT* | | LR5-WT/KT* $\phi 30$ |
| LR4/S/PJ | $\phi 5$ M4 | LR4/S/PJ $\phi 40$ |
| LR6/7-WJ | | LR6/7-WJ $\phi 40$ |
| LR7-WT/KT* | | LR7-WT/KT* $\phi 40$ |

Wiring Hole ($\phi 12$)
Nameplate Position
Recommended Torque: 0.6 N/m

Mount B Mounting Diagram [LJ]

For M8 bolt and nut size
Mounting Hole ($\phi 9$)
Recommended Torque: 30 N·m

For M10 bolt and nut size
Mounting Hole ($\phi 11$)
Recommended Bolt Torque: 12.2 N/m

- Drill mounting and wire distribution holes. For [KT] models select one of the two mounting options.
- Feed wires through appropriate holes.
- Secure product with bolts and nuts. (Bolts and nuts are separate purchase)













Mount C Mounting Diagram [QJ]

Mounting $\phi 6 \times 4$
Nut/Screw M5x4
Nameplate Position
Wiring Hole $\phi 15$
From Pole center 36.9
Bracket Shape
Recommended Torque: 1.4 N/m

Mount D Mounting Dimensional Drawing (M30 x 1.5 Installation)

Mounting Hole $\phi 31$
Nut M30
Nameplate Position
Wiring Hole
Recommended Torque: 4.5 N/m

Optional Parts and Poles

| | Model Number | Corresponding Model | | | |
|---|-----------------------|---------------------|---------------|------------|---------------|
| | | LR4 | LR5 | LR6 | LR7 |
|  | SZP-001W[U][K] | PJ, QJ | PJ, KT *1 | PJ, QJ | KT *1 |
|  | SZP-002U | PJ, QJ | PJ, KT *1 | PJ, QJ | KT *1 |
|  | SZP-003W[U][K] | PJ, QJ | PJ, KT *1 | PJ, QJ | KT *1 |
|  | SZP-090U | WJ | WJ, WT, KT *2 | - | - |
|  | SZP-091U | - | - | WJ | WJ, WT, KT *2 |
|  | SZL-001 | LJ | LJ, KT *1 | LJ | LJ, KT *1 |
|  | SZQ-001W | PJ, QJ | PJ, KT *1 | PJ, QJ | KT *1 |
|  | SZK-001U | LJ, PJ, QJ | LJ, PJ, KT *1 | LJ, PJ, QJ | KT *1 |
|  | SZK-002W[U][K] | WJ | WJ, WT, KT *2 | - | - |
|  | SZK-003W[U][K] | - | - | WJ | WJ, WT, KT *2 |
|  | SZK-004W | - | - | WJ | WJ, WT, KT *2 |
|  | SZW-001W | WJ | WJ, WT, KT *2 | WJ | - |



*1 Required pole and pole waterproof ring are not included with KT. *2 KT Direct Mount (Using accessory)

Aluminum Poles

Aluminum Poles (2 self-tapping screws included)

*Do not cut pole with a pole cutter. Please use a band saw, jigsaw, or sawing machine, etc.

*To convert from direct mount to pole mount, be sure to purchase the appropriate bracket and pole combination to make the change.

| Pole Type | Model Number | SZP-001W | SZP-002U | SZP-003W | SZQ-001W | SZK-001U | SZL-001 |
|--|-----------------------------------|----------|----------|----------|----------|----------|---------|
|  AN Type  ANK Type | POLE22-0100AN[K] 100mm | ○ | ○ | ○ | ○ | ○ | × |
| | POLE22-0300AN[K] 300mm | ○ | ○ | ○ | ○ | ○ | × |
| | POLE22-0500AN 500mm | × | ○ | × | × | ○ | × |
| | POLE22-0800AN[K] 800mm | × | ○ | × | × | ○ | × |
| | POLE22-1000AN 1000mm | × | ○ | × | × | ○ | × |
|  T Type Nuts Incl. | POLE22-0100AT 100mm | × | × | × | × | ○ | ○ |
| | POLE22-0300AT 300mm | × | × | × | × | ○ | ○ |
| | POLE22-0500AT 500mm | × | × | × | × | ○ | ○ |
| | POLE22-0800AT 800mm | × | × | × | × | ○ | ○ |
| | POLE22-1000AT 1000mm | × | × | × | × | ○ | ○ |

Conversion Brackets

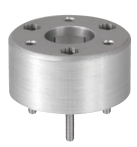

SZW-940U

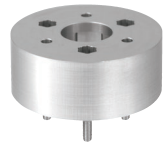

SZW-950U

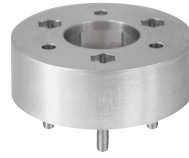

SZW-960U

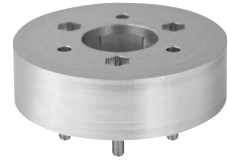

SZW-970U

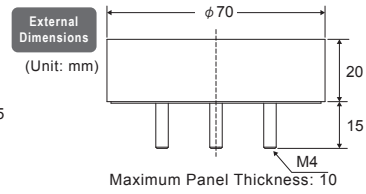
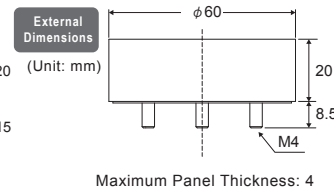
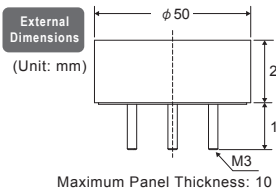
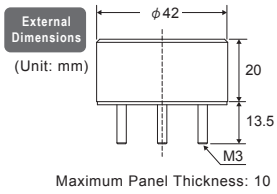

The Conversion Brackets allow you to install the LR Series Signal Towers using pre-existing mounting holes from previous models.

| Model Number | |
|--------------|--------------------------|
| SZW-940U | Nut with Flange (M3) x 3 |
| SZW-950U | |
| SZW-960U | Nut with Flange (M4) x 3 |
| SZW-970U | |

| Model Number | Size (mm) | Corresponding Models | |
|--------------|-----------|-----------------------|------------------|
| | | Previous | New |
| SZW-940U | φ 40 | LCE-W LCE-AW | LR4-WJ |
| SZW-950U | φ 50 | LE-W LES-AW LU5 | LR5-WJ LR5-WT |
| SZW-960U | φ 60 | LME-W | LR6-WJ |
| SZW-970U | φ 70 | LHE LU7 | LR7-WJ LR7-WT |

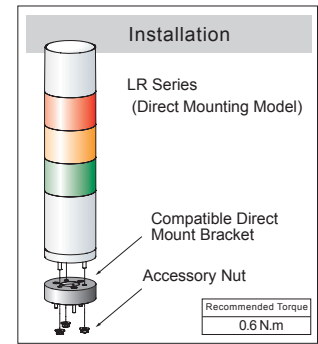

⚠ Pole mounting is not compatible.



| | Type | Material | Pole Diameter |
|------------------|------------|-----------------------|---------------|
| Previous product | LCE-A, LCS | Steel | φ 17.3 |
| | LE, LES | Steel | φ 17.3 |
| | LU5 | - | - |
| | LME, LMS | L: Steel, P: Aluminum | φ 21.7 |
| | LHE | - | - |
| New product | LU7 | - | - |
| | LR | Aluminum | φ 21.7 |

Pole Adapter

Since poles for the LR series are 21.7mm in diameter, this adapter can be used to install the LR series into pre-existing 17.3mm diameter holes.



SZP-917U

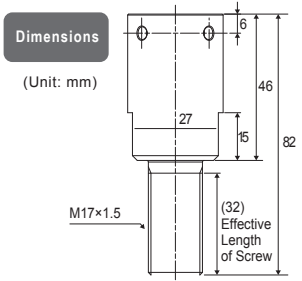

| Accessory | |
|---|--|
| Hexagon Socket Set Screws x 2 | |
| Hexagon Nut (M17) x 1 | |
| Plain Washer (φ 17.5 × φ 28 × t2.0) x 1 | |

| Model Number | Corresponding Models | |
|--------------|------------------------------------|------------------------------|
| | Previous | New |
| SZP-917U | LCE/LCE-A LCS/LCS-A LE/LES-A | LR□-□□□□J□□ POLE22-□□□□AT |

